

plastische chirurgie

plastic surgery 1

cirugía plástica

chirurgie plastique

chirurgia plastica

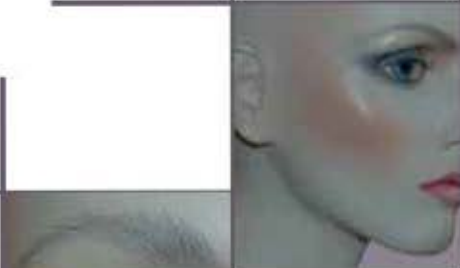

nopa[®] instruments



neck lift	<p>>> Hals Lifting >> Neck lift >> Lifting de cuello >> Lifting cervical >> Lifting del collo</p> <p>9–12</p>
rhino basic rhino advanced	<p>>> Rhinoplastik >> Rhinoplasty >> Rinoplastía >> Rhinoplastie >> Rinoplastica</p> <p>13–30</p>
otoplasty	<p>>> Otoplastik >> Otoplasty >> Otoplastía >> Otoplastie >> Otoplastica</p> <p>31–34</p>
facelift facelift endoscopy	<p>>> Facelifting >> Facelifting >> Lifting facial >> Lifting facial >> Lifting facciale</p> <p>35–46</p>
blepharoplasty	<p>>> Augenlidplastik >> Blepharoplasty >> Blepharoplastía</p> <p>>> Blépharoplastie >> Blefaroplastica</p> <p>47–52</p>
hair transplantation	<p>>> Haartransplantation >> Hair transplantation >> Transplante de cabello</p> <p>>> Greffe des cheveux >> Trapianto capelli</p> <p>53–58</p>

>> Klemmen >> Hemostats >> Pinzas hemostáticas >> Pincas hémostatiques >> Pinze emostatiche	59–76	AA
>> Pinzetten >> Forceps >> Pinzas >> Pínces >> Pinze	77–102	AB
>> Scheren >> Scissors >> Tijeras >> Ciseaux >> Forbici	103–138	AC
>> Skalpelle >> Scalpels >> Bisturíes >> Bistouris >> Bisturi	139–146	AD
>> Naht >> Suture >> Sutura >> Suture >> Sutura	147–174	AE
>> Tupferzangen >> Sponge Forceps >> Pinzas para pólipos >> Pincas à pansements >> Pinze per polipi	175–180	AF
>> Wundhaken >> Retractors >> Separadores >> Ecarteurs >> Divaricatori	181–198	AK
>> Sonden >> Probes >> Sondas >> Sondes >> Sonde	199–202	AL
>> Punktion/Kanülen >> Puncture/Special Needles >> Punción/Agujas especiales >> Ponction/Aiguilles spéciales >> Puntura/Aghi speciali	203–214	AO
>> Narkose >> Anaesthesia >> Anestesia >> Anesthésie >> Anestesia	215–226	AP
>> Diagnostik >> Diagnostics >> Diagnóstico >> Diagnostic >> Diagnostica	227–236	AR
>> Orthopädie >> Orthopaedic >> Ortopedia >> Orthopédie >> Ortopedia	237–266	KA
>> Mund/Zunge/Tonsillen >> Oral Instruments/Tonsils >> Boca/Lengua/Amígdalas >> Bouche/Langue/Amygdales >> Bocca/Lingua/Tonsille	267–296	KL
>> Otologie >> Otology >> Otológia >> Otologie >> Otológia	297–328	KM
>> Rhinologie >> Rhinology >> Rinología >> Rhinologie >> Rinología	329–374	KO
>> Verschiedenes >> Various items >> Diversos Artículos >> Articles divers >> Articoli diversi	375–380	KU
>> Container System >> Container System >> Sistema de contenedor >> Système de conteneur >> Sistema del contenitore	381–412	KYE
>> Endoskopie >> Endoscopy >> Endoscópia >> Endoscopie >> Endoscopia	413–446	X



HALS LIFTING
NECK LIFT
LIFTING DE CUELLO
LIFTING CERVICAL
LIFTING DEL COLLO

SET

ZS 200/01

Siebvorschlag - Suggested instrument set



ZS 200/01	Content:	Qty
AA 751/13	BACKHAUS TOWEL FORCEPS, 13,0 CM	4
AD 010/03	SCALPEL HANDLE NO.3	1
AD 075/10	PCK=100 SCALPEL BLADES, FIG.10	1
AD 075/15	PCK=100 SCALPEL BLADES, FIG.15	1
AF 200/18	FOERSTER-BALLENGER SPONGE HOLDING FORCEPS, STRAIGHT, 18,0 CM	1
AO 501/12	HANDLES FOR LIPOSUCTION AND INFILTRATION CANNULA WITH QUICK CONNECTOR	1
AO 515/06	MONOPORT CANNULA, 20,0 CM Ø 3 MM	1
AO 516/06	TRIPORT CANNULA, 20,0 CM Ø 3 MM	1
AO 517/06	MERCEDES CANNULA, 20,0 CM Ø 3 MM	1
AO 518/06	SPIRALE CANNULA, 20,0 CM Ø 3 MM	1
AO 519/06	SHARK CANNULA, 20,0 CM Ø 3 MM	1
AO 520/06	COBRA CANNULA, 20,0 CM Ø 3 MM	1
KYE 304/50	WIRE BASKET, 267 X 125 X 50 MM	1
KYE 810/01	SILICON MAT, 275 x 125 MM	1

Sterilizing Container KYE 351/01, if required.



BACKHAUS
AA 751/13
13,0 cm/5"



AD 010/03
No. 3



Fig.10
AD 075/10



Fig.15
AD 075/15

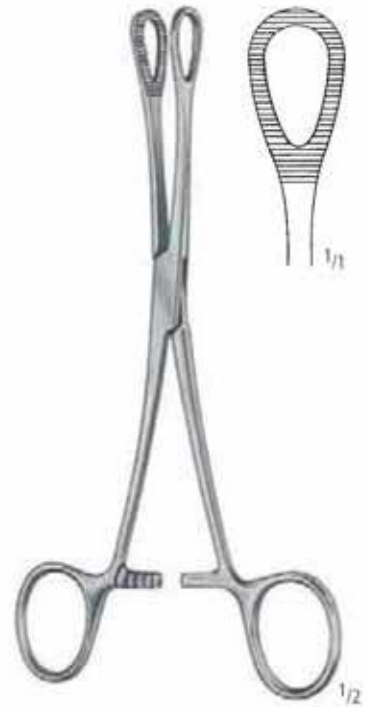

FOERSTER-BALLENGER
AF 200/18
18,0 cm/7"

HALS LIFTING NECK LIFT LIFTING DE CUELLO LIFTING CERVICAL LIFTING DEL COLLO



AO 501/12



20,0 cm/8"
Ø 3 mm



MONOPOINT
AO 515/06



SPIRALE
AO 518/06



TRIPOINT
AO 516/06



SHARK
AO 519/06



MERCEDES
AO 517/06



COBRA
AO 520/06



KYE 304/50

L(mm)	B(mm)	H(mm)
267	125	50



KYE 810/01

L(mm)	B(mm)
275	125

RHINOPLASTIK BASIC
RHINOPLASTY BASIC
RHINOPLASTIA BASIC
RHINOPLASTIE BASIC
RHINOPLASTICA BASIC

SET

ZS 203/01

Siebvorschlag - Suggested instrument set



RHINOPLASTIK RHINOPLASTY RHINOPLASTIA RHINOPLASTIE RHINOPLASTICA

ZS 203/01	Content:	Qty
AA 751/11	BACKHAUS TOWEL FORCEPS, 11,0 CM	5
AB 070/10	DRESSING FORCEPS, 10,5 CM	1
AB 100/12	ADSON DRESSING FORCEPS, 12,0 CM	1
AB 660/16	JANSEN EAR AND NOSE DRESSING FORCEPS, 16,0 CM	1
AB 714/10	GRAEFE IRIS FORCEPS, 1X2 T., 10,0 CM	1
AB 794/11	ELSCHNIG FIXATION FORCEPS, 3X4 T., 11,0 CM	1
AB 930/12	ADSON FORCEPS TUC, 12,0 CM	1
AC 205/14	JOSEPH DISSECTING SCISSORS, 14,0 CM	1
AC 317/18	HEYMANN NASAL SCISSORS, 18,0 CM	1
AC 471/10	WILMER EYE SCISSORS, 10,0 CM	1
AC 613/10	CUTICLE SCISSORS, 10,0 CM	1
AC 903/14	STANDARD SCS TUC CVD SH/BL 14,5 CM	1
AD 027/07	SCALPEL HANDLE NO.7K	1
AD 075/15	PCK=100 SCALPEL BLADES, FIG.15	1
AD 401/13	DIEFFENBACH ABSCESS KNIFE, 13,0 CM	1
AE 448/17	SENNING NEEDLE HOLDER, SWED MOD, TUC, 17,0 CM	1
AE 466/13	HALSEY NEEDLE HOLDER TUC, 13,0 CM	1
AL 100/14	FARREL COTTON APPLICATOR, 14,0 CM	1
AO 434/09	FERGUSON SUCTION TUBE	1
KA 695/05	SEBILEAU ELEVATOR, 17,5 CM	1
KL 130/19	BRUENINGS TONGUE DEPRESSOR, 19,0 CM	1
KO 052/01	HARTMANN NASAL SPECULUM, 15,0 CM	1
KO 070/75	KILLIAN NASAL SPECULUM, 13,0 CM	1
KO 090/02	COTTLE NASAL SPECULUM, 15,0 CM (WITHOUT FIXING SCREW)	1
KO 152/20	LUBET-BARBON NASAL POLYPUS FORCEPS, 20,0 CM	1
KO 200/01	WEIL-BLAKESLEY NASAL CUTTING FORCEPS, W/O NECK, 12,5 CM	1
KO 200/03	WEIL-BLAKESLEY NASAL CUTTING FORCEPS, W/O NECK, 12,5 CM	1
KO 201/02	WEIL-BLAKESLEY NASAL CUTTING FORCEPS, CVD. UP, 12,5 CM	1
KO 220/12	TAKAHASHI NASAL CUTTING FORCEPS, 12,5 CM	1
KO 307/15	COTTLE KNIFE, 15,0 CM	1
KO 340/05	MC KENTY SEPTUM ELEVATOR	1
KO 349/23	COTTLE SEPTUM ELEVATOR, D/E, 23,0 CM	1
KO 353/21	MASING SEPTUM ELEVATOR, D/E, 21,0 CM	1
KO 392/21	COTTLE NASAL RASP, 21,0 CM	1
KO 400/01	JOSEPH MUCOUS HOOK, UPWARDS, 21,0 CM	1
KO 400/05	JOSEPH MUCOUS HOOK, 2-PRONGS, 16,0 CM	1
KO 416/15	COTTLE RETRACTOR, 15,0 CM	1
KO 428/14	AUFRIECHT(WALTER) RETRACTOR, 13,5 CM	1
KO 435/11	COTTLE COLUMELLA FORCEPS, 11,0 CM	1
KO 610/04	COTTLE OSTEOTOMES, 18,0 CM	1
KO 610/07	COTTLE OSTEOTOMES, 18,0 CM	1
KO 635/04	WALTER CHISEL, 19,0 CM	1
KO 801/19	COTTLE MALLETT, 240G, 19,0 CM	1
KU 300/11	MIXING BOWL, 116 x 50 MM	1
XR 830/03	CONNECTION CORD BIPOLAR, 300 CM	1
XR 894/16E	BI-COAGULATION-FORCEPS NEEDLE, 16,0 CM	1
KYE 302/05	WIRE BASKET, 255 x 245 x 50 MM	1
KYE 810/03	SILICON MAT, 300 x 300 MM	1

Sterilizing Container KYE 200/01, if required.



BACKHAUS
AA 751/11
11,0 cm/4¹/₃"



ADSON
AB 070/10
10,5 cm/4¹/₄"



ADSON
AB 100/12
12,0 cm/4³/₄"



JANSEN
AB 660/16
16,0 cm/6¹/₄"



GRAEFE
AB 714/10
10,0 cm/4"



ELSCHNIG 3:4
AB 794/11
11,0 cm/4¹/₃"



ADSON
AB 930/12
12,0 cm/4³/₄"

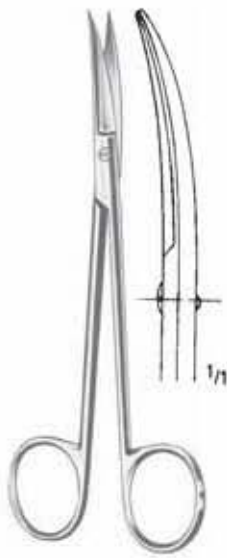

JOSEPH
AC 205/14
14,0 cm/5¹/₂"



HEYMANN
AC 317/18
18,0 cm/7"

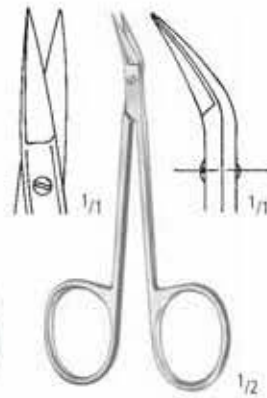

WILMER
AC 471/10
10,0 cm/4"

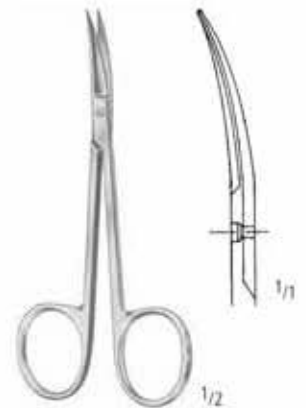

AC 613/10
10,0 cm/4"

neck lift

rhino basic

rhino advanced

otoplasty

facelift

facelift: endoscopy

blepharoplasty

hairtransplantation

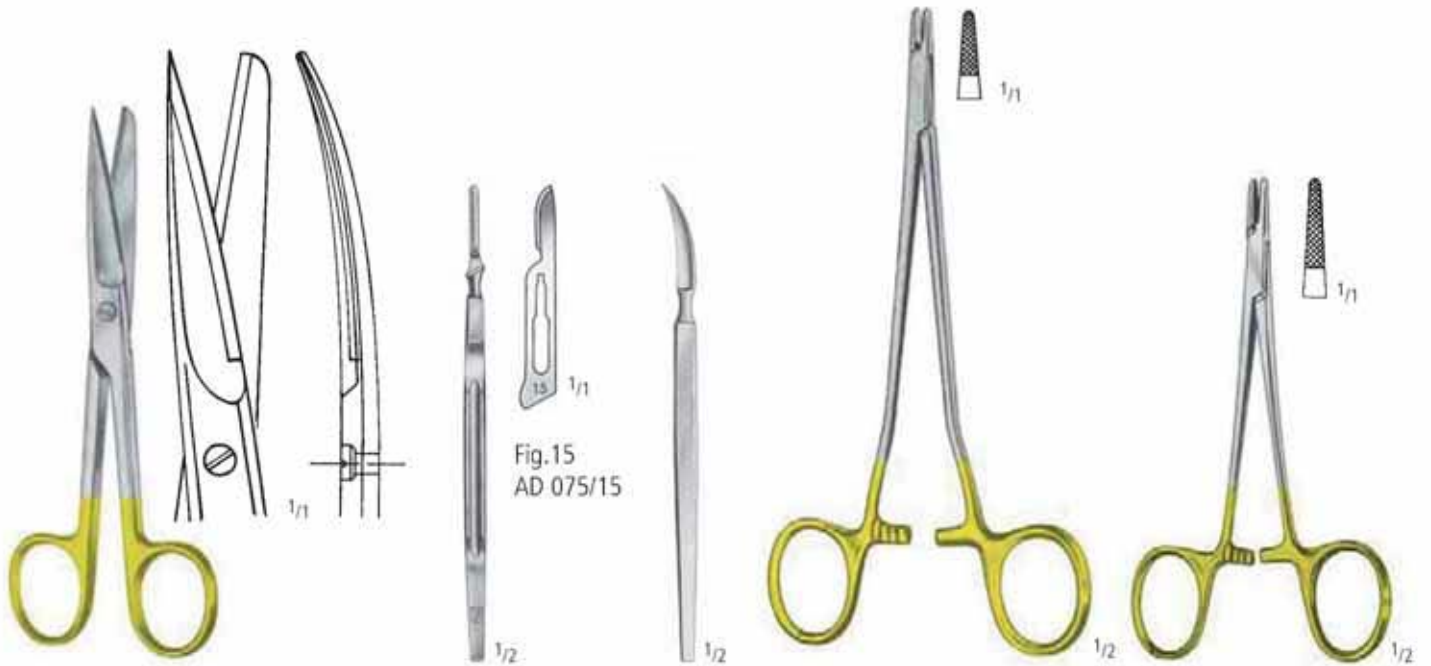

STANDARD
AC 903/14
14,5 cm/5³/₄"

AD 027/07
No. 7K

DIEFFENBACH
AD 401/13
13,0 cm/5"

SENNING (SWEDISH PATTERN)
AE 448/17
17,0 cm/6³/₄"

HALSEY
AE 466/13
13,0 cm/5"



FARREL
AL 100/14
14,0 cm/5¹/₂"

FERGUSSON
AO 434/09
9 Charr.

SEBILEAU
KA 695/05
17,5 cm/7"

BRUENINGS
KL 130/19
19,0 cm/7¹/₂"

HARTMANN
KO 052/01
15,0 cm/6"



KILLIAN
KO 070/75
13,0 cm/5"



COTTLE
KO 090/02
15,0 cm/6"

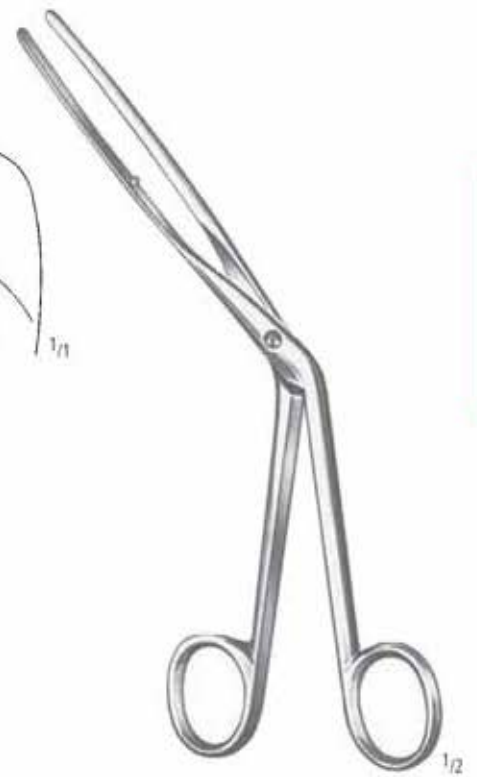

LUBET-BARBON
KO 152/20
20,0 cm/8"

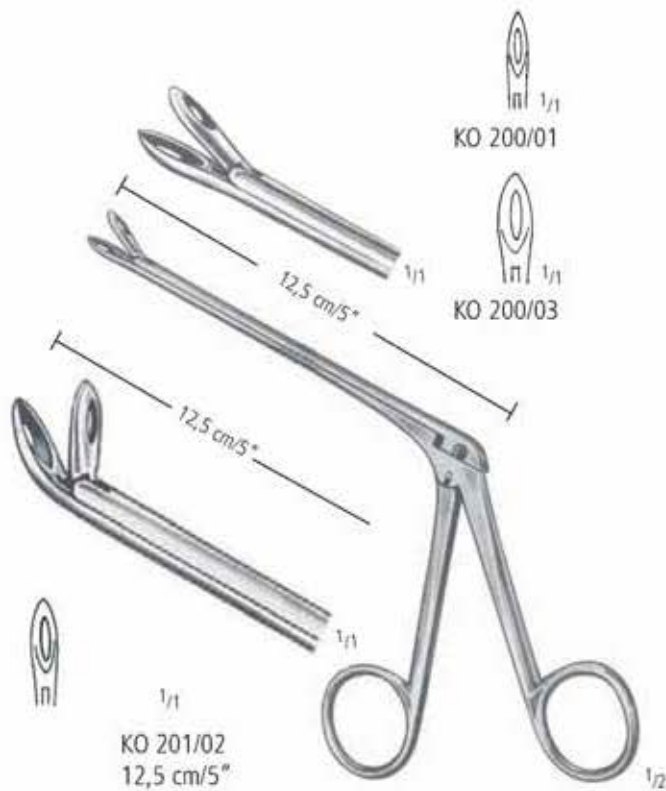

KO 201/02
12,5 cm/5"

WEIL-BLAKESLEY



TAKAHASHI
KO 220/12
12,5 cm/5"

neck lift

rhino basic

rhino advanced

otoplasty

facelift

facelift endoscopy

blepharoplasty

hair transplantation



COTTLE
KO 307/15
15,0 cm/6"



McKENTY
KO 340/05
5,0 mm



COTTLE
KO 349/23
23,0 cm/9"



MASING
KO 353/21
21,0 cm/8¹/₄"

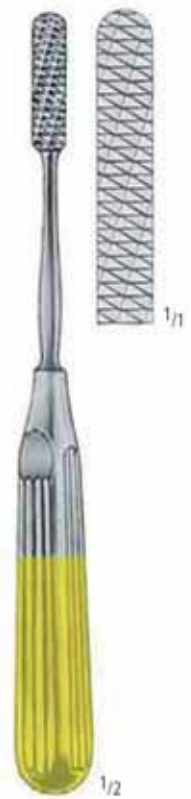

COTTLE
KO 392/21
21,0 cm/8¹/₄"



JOSEPH
KO 400/01
15,0 cm/6"



JOSEPH
KO 400/05
16,0 cm/6¹/₄"



COTTLE
KO 416/15
15,0 cm/6"



AUFRICHT (WALTER)
KO 428/14
13,5 cm/5¹/₄"



COTTLE
KO 435/11
11,0 cm/4¹/₃"

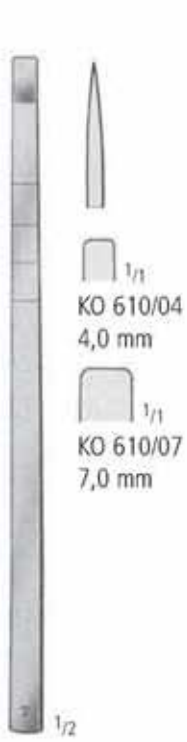

COTTLE
18,0 cm/7"



WALTER
KO 635/04
19,0 cm/7³/₄"



COTTLE
KO 801/19
19,0 cm/7¹/₂"



KU 300/11
Ø x h
116 x 50 mm 0,35 l

bipolar
Connecting cable



MARTIN / BERCHTHOLD
XR 830/03
300 cm

E=Nadel



XR 894/16E
16,0 cm/6¹/₄"



KYE 302/05
L(mm) B(mm) H(mm)
255 245 50



KYE 810/03
L(mm) B(mm)
300 300

RHINOPLASTIK ADVANCED
RHINOPLASTY ADVANCED
RHINOPLASTIA ADVANCED
RHINOPLASTIE ADVANCED
RHINOPLASTICA ADVANCED

SET

ZS 203/02

Siebvorschlag - Suggested instrument set



RHINOPLASTIK RHINOPLASTY RHINOPLASTIA RHINOPLASTIE RHINOPLASTICA

ZS 203/02		Content:	Qty
AA	751/11	BACKHAUS TOWEL FORCEPS 11,0 CM	8
AB	930/12	ADSON FORCEPS TUC, 12,0 CM	1
AB	932/12	ADSON FORCEPS TUC, 1X2 TEETH, 12,0 CM	1
AC	042/13	GRAZIL OPERATING SCISSORS, SH/BL 13,0 CM	1
AC	205/14	JOSEPH DISSECTING SCISSORS, 14,0 CM	1
AC	471/10	WILMER EYE SCISSORS, 10,0 CM	1
AC	473/11	CHADWICK EYE SCISSORS, 11,0 CM	1
AC	985/11	IRIS SCS.TUC, CVD, SH, 11,5 CM	1
AD	010/03	SCALPEL HANDLE NO.3	1
AD	027/07	SCALPEL HANDLE NO.7K	1
AD	065/13	SCALPEL HANDLE MINI 13,0 CM	1
AD	065/69	PCK=10 MINI SCALPEL BLADES, FIG.69	1
AD	075/11	PCK=100 SCALPEL BLADES, FIG.11	1
AD	075/15	PCK=100 SCALPEL BLADES, FIG.15	1
AE	448/17	SENNING NEEDLE HOLDER SWEDISH MODEL, TUC, 17,0 CM	1
AE	456/13	NEIVERT NEEDLE HOLDER, TUC, 13,0 CM	1
AL	100/14	FARREL COTTON APPLICATOR, 14,0 CM	1
AO	430/06	FRAZIER SUCTION TUBE, 17,0 CM	1
AO	430/08	FRAZIER SUCTION TUBE, 17,0 CM	1
AO	450/04	ADSON SUCTION TUBE, 21,0 CM	1
AR	282/20	CASTROVIEJO CIRCLE, STRAIGHT, 8,0 CM	1
KA	870/19	COTTLE KAZANJIAN BONE CUTTING FORCEPS, 19,0 CM	1
KO	052/01	HARTMANN NASAL SPECULUM, 15,0 CM	1
KO	070/75	KILLIAN NASAL SPECULUM, 13,0 CM	1
KO	070/90	KILLIAN NASAL SPECULUM, 13,0 CM	1
KO	090/02	COTTLE NASAL SPECULUM, 15,0 CM (without fixing screw)	1
KO	155/19	HARTMANN NASAL POLYPUS FORCEPS, 19,0 CM	1
KO	200/01	WEIL-BLAKESLEY NASAL CUTTING FORCEPS, W/O NECK, 12,5 CM	1
KO	200/03	WEIL-BLAKESLEY NASAL CUTTING FORCEPS, W/O NECK, 12,5 CM	1
KO	205/12	WATSON-WILLIAMS NASAL CUTTING FORCEPS, 12,5 CM	1
KO	305/13	MASING KNIFE, 13,0 CM	1
KO	307/15	COTTLE KNIFE, 15,0 CM	1
KO	340/05	MC KENTY SEPTUM ELEVATOR, 5MM	1
KO	341/22	JOSEPH-MASING SEPTUM ELEVATOR, 22,0 CM	1
KO	349/23	COTTLE SEPTUM ELEVATOR, D/E, 23,0 CM	1
KO	352/21	COTTLE SEPTUM ELEVATOR, D/E, 21,0 CM	1
KO	362/01	JOSEPH NASAL SAW BAYONET-SHAPE LEFT, 19,0 CM	1
KO	362/02	JOSEPH NASAL SAW BAYONET-SHAPE RIGHT, 19,0 CM	1
KO	395/01	FOMON NASAL RASP, D/E, 20,0 CM	1
KO	395/05	FOMON NASAL RASP, D/E, 20,0 CM	1
KO	402/16	COTTLE DELICATE HOOK, 16,0 CM	1
KO	408/01	COTTLE DELICATE HOOK, 2-PRONGS, 14,0 CM	1
KO	408/02	COTTLE DELICATE HOOK, 2-PRONGS, 14,0 CM	1
KO	409/00	COTTLE(MILLARD) DELICATE HOOKS, 2-PRONGS	1
KO	412/20	COTTLE-NEIVERT RETRACTOR, D/E, 20,0 CM	1
KO	414/20	MASING RETRACTOR, 20,0 CM	1
KO	416/15	COTTLE RETRACTOR, 15,0 CM	1
KO	430/45	AUFRICHT RETRACTOR, 19,0 CM	1
KO	435/11	COTTLE COLUMELLA FORCEPS, 11,0 CM	1
KO	610/04	COTTLE OSTEOTOMES, 18,0 CM	1
KO	610/07	COTTLE OSTEOTOMES, 18,0 CM	1
KO	610/09	COTTLE OSTEOTOMES, 18,0 CM	1
KO	613/04	COTTLE CHISEL, 18,0 CM	1
KO	614/16	COTTLE OSTEOTOMES, 18,0 CM	1
KO	643/00	MASING OSTEOTOME, STRAIGHT, 17,5 CM	1
KO	643/01	MASING OSTEOTOMES, 17,5 CM	1
KO	643/02	MASING OSTEOTOMES, 17,5 CM	1
KO	644/02	SILVER CHISEL, 18,0 CM	1
KO	751/00	WALSHAM SEPTUM STRAIGHTENING FORCEPS, 23,0 CM	1
KO	753/20	RUBIN SEPTUM STRAIGHTENING FORCEPS, 20,0 CM	1
KO	754/70	KRESSNER SEPTUM FORCEPS, 20,0 CM	1
KO	756/00	COTTLE CARTILAGE CRUSHER	1
KO	801/19	COTTLE MALLET, 240G, 19,0 CM	1
KU	300/11	MIXING BOWL, 116 x 50 MM	1
XR	830/03	CONNECTION CORD BIPOLAR, 300 CM	1
XR	894/16E	BI-COAGULATION-FORCEPS NEEDLE, 16,0 CM	1
KYE	300/05	WIRE BASKET, 485 x 255 x 50 MM	1
KYE	810/02	SILICON MAT, 225 x 225 MM	2

Sterilizing Container KYE 200/61, if required.

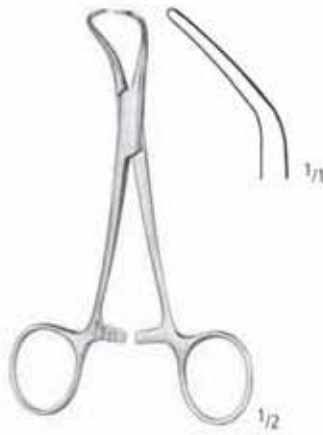

BACKHAUS
AA 751/11
11,0 cm/4¹/₃"



ADSON
AB 930/12
12,0 cm/4³/₄"



ADSON
AB 932/12
12,0 cm/4³/₄"



GRAZIL
AC 042/13
13,0 cm/5"



JOSEPH
AC 205/14
14,0 cm/5¹/₂"



WILMER
AC 471/10
10,0 cm/4"



CHADWICK
AC 473/11
11,0 cm/4¹/₃"



AC 985/11
11,5 cm/4¹/₂"



AD 010/03
No. 3

neck lift

rhino basic

rhino advanced

otoplasty

facelift

facelift endoscopy

blepharoplasty

hairtransplantation

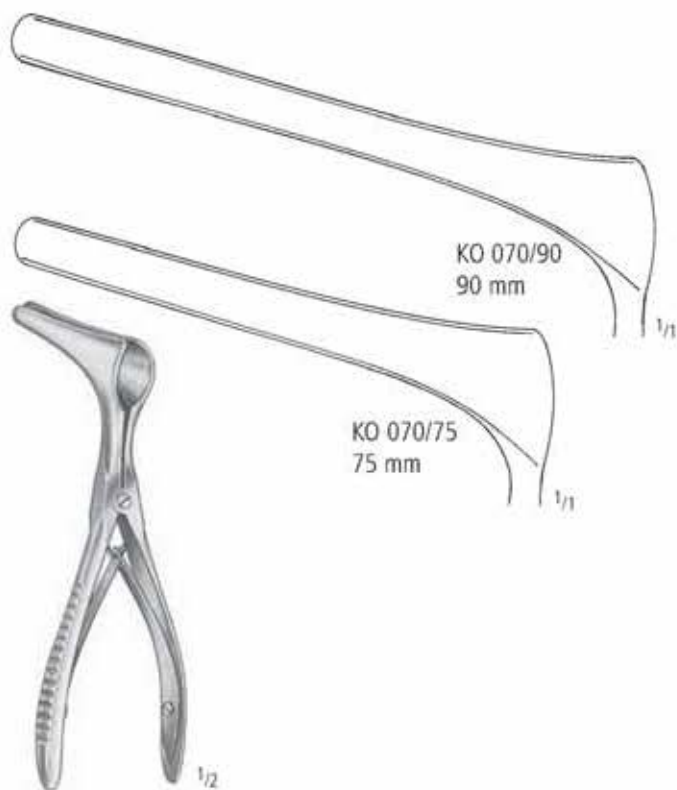

KILLIAN
13,0 cm/5"



COTTLE
KO 090/02
15,0 cm/6"



HARTMANN
KO 155/19
19,0 cm/7½"

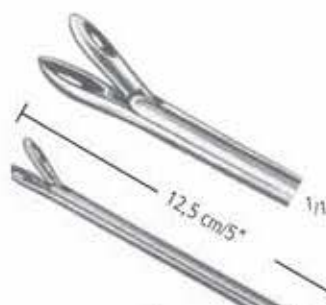

KO 200/01

KO 200/03



WATSON-WILLIAMS
KO 205/12



WEIL-BLAKESLEY

neck lift

rhino basic

rhino advanced

otoplasty

facelift

facelift endoscopy

blepharoplasty

hairtransplantation



MASING
KO 305/13
13,0 cm/5"



COTTLE
KO 307/15
15,0 cm/6"

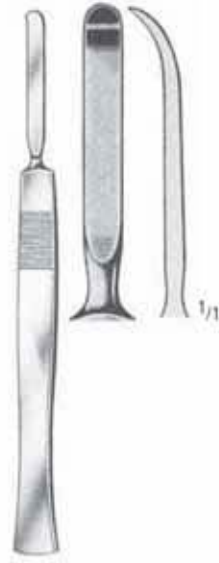

McKENTY
KO 340/05
5,0 mm



JOSEPH-MASING
KO 341/22
22,0 cm/8³/₄"



COTTLE
KO 349/23
23,0 cm/9"



COTTLE
KO 352/21
21,0 cm/8¹/₂"



JOSEPH
19,0 cm/7¹/₂"



FOMON
20,0 cm/8"



KO 395/01



KO 395/05



COTTLE
KO 402/16
16,0 cm/6¹/₄"



COTTLE
14,0 cm/5¹/₂"



COTTLE (MILLARD)
KO 409/00



COTTLE-NEIVERT
KO 412/20
20,0 cm/8"



MASING
KO 414/20
20,0 cm/8"



COTTLE
KO 416/15
15,0 cm/6"



AUFRICHT
KO 430/45
16,0 cm/6 1/4"



COTTLE
KO 435/11
11,0 cm/4 1/8"

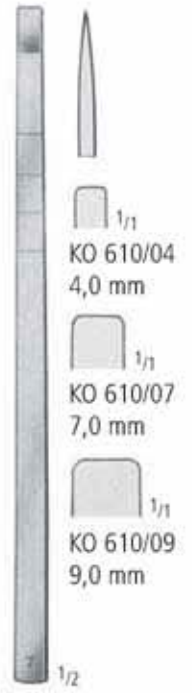

COTTLE
18,0 cm/7"

1/1
KO 610/04
4,0 mm

1/1
KO 610/07
7,0 mm

1/1
KO 610/09
9,0 mm

neck lift

rhino basic

rhino advanced

otoplasty

facelift

facelift endoscopy

blepharoplasty

hair transplantation

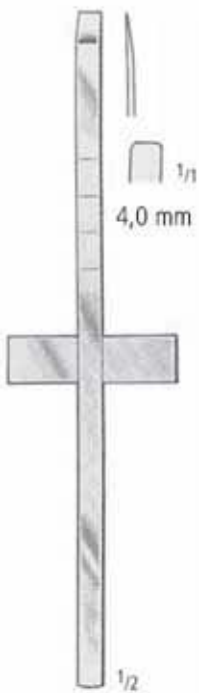

COTTLE
KO 613/04
18,0 cm/7"



COTTLE
KO 614/16
18,0 cm/7"



MASING
KO 643/00
17,5 cm/7"



MASING
KO 643/01
17,5 cm/7"



MASING
KO 643/02
17,5 cm/7"



SILVER
KO 644/02
18,0 cm/7"



WALSHAM
KO 751/00
23,0 cm/9"



RUBIN
KO 753/20
20,0 cm/8"

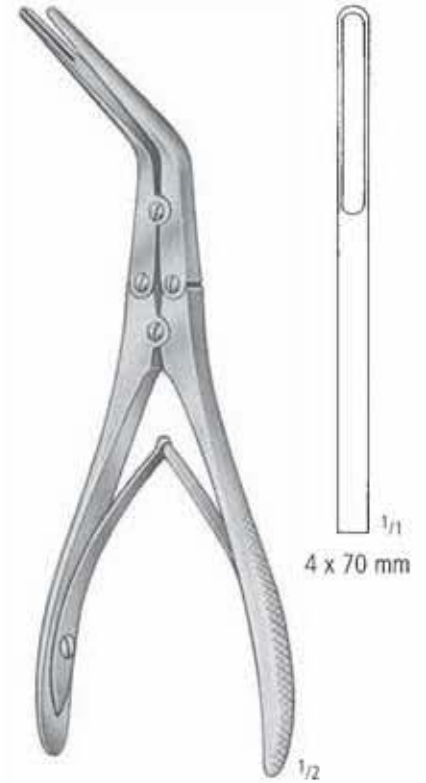

KRESSNER
KO 754/70
20,0 cm/8"

Knorpelquetscher
Cartilage crusher
Trituradora de sustancia cartilaginosa
Presse pour matière cartilagineuse
Trita cartilagine



COTTLE
KO 756/00



COTTLE
KO 801/19
19,0 cm/7 1/2"

Ø 30,0 mm
240 g



KU 300/11
Ø x h
116 x 50 mm 0,35 l

bipolar
Connecting cable



MARTIN / BERCHTHOLD
XR 830/03
300 cm

E=Nadel



XR 894/16E
16,0 cm/6 1/4"



KYE 300/05
L(mm) 485 B(mm) 255 H(mm) 50



KYE 810/02
L(mm) 225 B(mm) 225

neck lift

rhino basic

rhino advanced

otoplasty

facelift

facelift endoscopy

blepharoplasty

hair transplantation

OTOPLASTIK
OTOPLASTY
OTOPLASTIA
OTOPLASTIE
OTOPLASTICA

SET

ZS 205/01

Siebvorschlag - Suggested instrument set



ZS 205/01	Content:	Qty
AB 060/16	STANDARD TISSUE FORCEPS, 1X2 T., STRAIGHT, 16,0 CM	1
AB 116/09	ADSON-BROWN TISSUE FORCEPS, 9X9 T., STRAIGHT, 12,0 CM	1
AC 981/13	GOLDMAN-FOX SCISSORS TUC, CURVED, 13,0 CM	1
AD 010/03	SCALPEL HANDLE NO.3	2
AD 075/10	PCK=100 SCALPEL BLADES, FIG.10	1
AE 466/13	HALSEY NEEDLE HOLDER TUC, 13,0 CM	1
AK 022/15	KILNER DELICATE HOOK FINE, 15,0 CM	1
AK 072/02	JOSEPH DELICATE HOOK, 2 PRONGS FINE, 16,0 CM	1
KO 409/00	COTTLE(MILLARD) DELICATE HOOKS, 2-PRONGS	1
KU 300/11	MIXING BOWL, 116 x 50 MM	1
XR 830/03	CONNECTION CORD BIPOLAR, 300 CM	1
XR 894/16E	BI-COAGULATION-FORCEPS, NEEDLE 16,0 CM	1
KYE 304/50	WIRE BASKET, 267 x 125 x 50 MM	1
KYE 810/01	SILICON MAT, 275 x 125 MM	1

Sterilizing Container KYE 351/01, if required.



STANDARD 1:2
AB 060/16
16,0 cm/6¹/₄"



ADSON-BROWN
AB 116/09
12,0 cm/4³/₄"

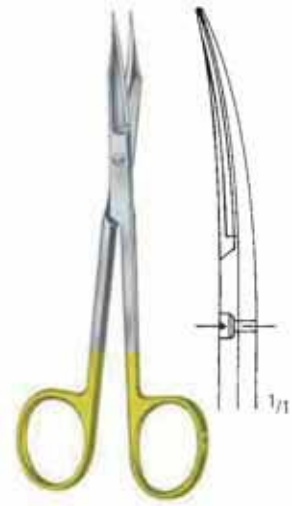

GOLDMAN-FOX
AC 981/13
13,0 cm/5"

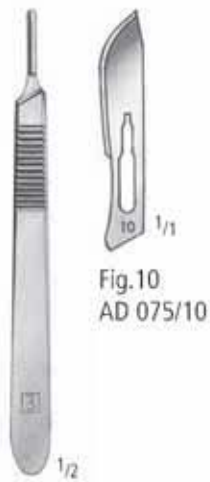

AD 010/03
No. 3



HALSEY
AE 466/13
13,0 cm/5"



KILNER
AK 022/15
15,0 cm/6"



JOSEPH
AK 072/02
16,0 cm/6¹/₄"

neck lift

rhino basic

rhino advanced

otoplasty

facelift

facelift endoscopy

blepharoplasty

hair transplantation



COTTLE (MILLARD)
KO 409/00



KU 300/11
Ø x h
116 x 50 mm 0,35 l

bipolar
Connecting cable



MARTIN / BERCHTHOLD
XR 830/03
300 cm



XR 894/16E
16,0 cm/6¹/₄"



KYE 304/50

L(mm)	B(mm)	H(mm)
267	125	50



KYE 810/01

L(mm)	B(mm)
275	125

FACELIFTING
FACELIFTING
LIFTING FACIAL
LIFTING FACIAL
LIFTING FACCIALE

SET

ZS 207/01

Siebvorschlag - Suggested instrument set



FACELIFTING FACELIFTING LIFTING FACIAL LIFTING FACIAL LIFTING FACCIALE

ZS 207/01	Content:	Qty
AA 078/14	MARTEL FLAP FORCEPS, 14,0 CM	1
AA 751/11	BACKHAUS TOWEL FORCEPS, 11,0 CM	1
AB 112/12	MICRO-ADSON TISS. FORCEPS, 1X2 T., 12,0 CM	1
AB 116/07	ADSON-BROWN TISS. FORCEPS, STR., 7X7 T., 12,0 CM	1
AB 260/20	BROPHY TISSUE FORCEPS, 1X2 T., 20,0 CM	1
AC 166/20	GORNEY DISSECTING SCS, STR., TOOTHED, 19,5 CM	1
AC 167/20	GORNEY DISSECTING SCS, CVD, TOOTHED, 19,5 CM	1
AC 910/145C	MAYO DISSECTING SCISSORS TUC, BL/BL, SC, STRAIGHT, 14,5 CM	1
AC 983/15	KAYE FACE LIFT SCISSORS, TOOTHED, CVD, 15,0 CM	1
AC 985/11	IRIS SCS,TUC, CVD, SH, 11,5 CM	1
AD 025/07	SCALPEL HANDLE NO.7	1
AD 075/15	PCK=100 SCALPEL BLADES, FIG.15	1
AE 466/13	HALSEY NEEDLE HOLDER TUC, 13,0 CM	1
AE 468/15	BABY-CRILE-WOOD NEEDLE HOLDER TUC, 15,0 CM	1
AK 020/01	GILLIES DELICATE HOOK, FIG.1, FINE, 18,0 CM	1
AK 072/05	JOSEPH DELICATE HOOK, 16,0 CM	1
AK 128/19	WALTER RETRACTOR	1
AK 233/06	KÖCHER-LANGENBECK RETRACTOR, ANGLED, 21,5 CM	1
AK 354/00	FARABEUF RETRACTOR SET, FIG.1+2, 15,0 CM	1
AO 501/12	HANDLES FOR LIPOSUCTION AND INFILTRATION CANNULA WITH QUICK CONNECTOR	1
AO 515/06	MONOPORT CANNULA, 20,0 CM, Ø 3 MM	1
AO 516/06	TRIPORT CANNULA, 20,0 CM, Ø 3 MM	1
AO 518/06	SPIRALE CANNULA, 20,0 CM, Ø 3 MM	1
AR 297/16	FACELIFT MARKER, 16,0 CM	1
KL 114/15	HARTMANN TONGUE DEPRESSOR, 15,0 CM	1
KYE 302/05	WIRE BASKET, 255 x 245 x 50 MM	1
KYE 810/03	SILICON MAT, 300 x 300 MM	1

Sterilizing Container KYE 200/01, if required.

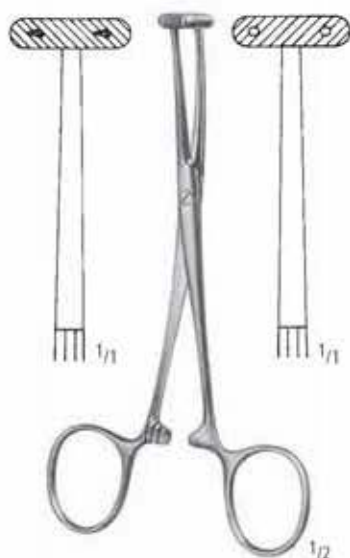

MARTEL
AA 078/14
14,0 cm/5 1/2"



BACKHAUS
AA 751/11
11,0 cm/4 1/3"



MICRO-ADSON 1:2
AB 112/12
12,0 cm/4 3/4"



ADSON-BROWN
AB 116/07
12,0 cm/4 3/4"



BROPHY 1:2
AB 260/20
20,0 cm/8"

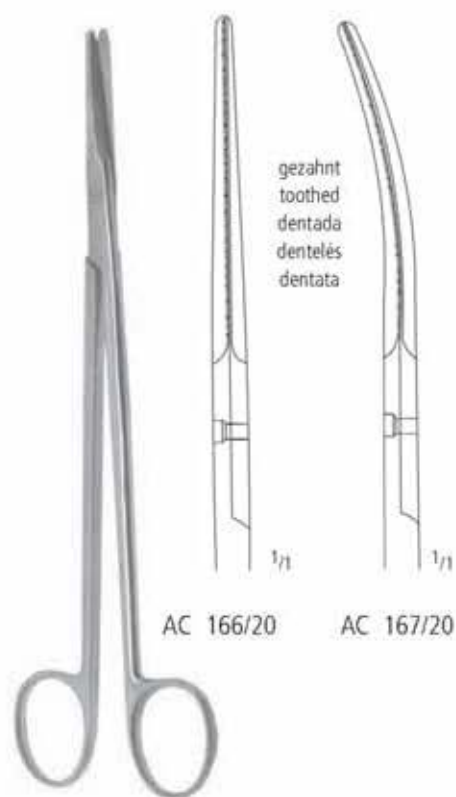

GORNEY
19,5 cm/7 3/4"

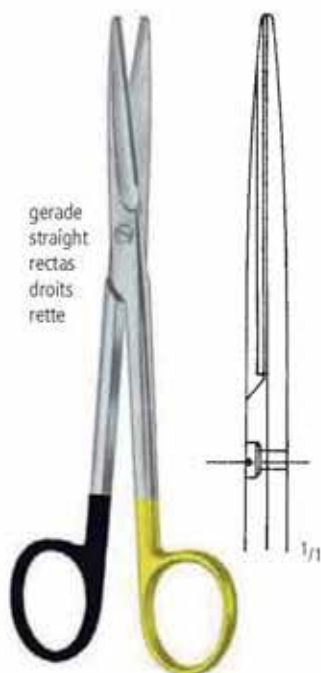

MAYO
AC 910/14 SC
14,5 cm/5 1/2"

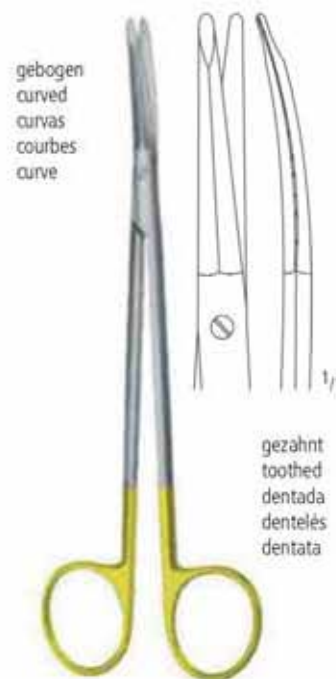

KAYE
AC 983/15
14,5 cm/5 3/4"

neck lift

rhino basic

rhino advanced

otoplasty

facelift

facelift: endoscopy

blepharoplasty

hairtransplantation



AC 985/11
11,5 cm/4¹/₂"



AD 025/07
No. 7

Fig.15
AD 075/15



HALSEY
AE 466/13
13,0 cm/5"



BABY-CRILE-WOOD
AE 468/15
15,0 cm/6"



GILLIES
AK 020/01
18,0 cm/7"



JOSEPH
AK 072/05
16,0 cm/6¹/₄"

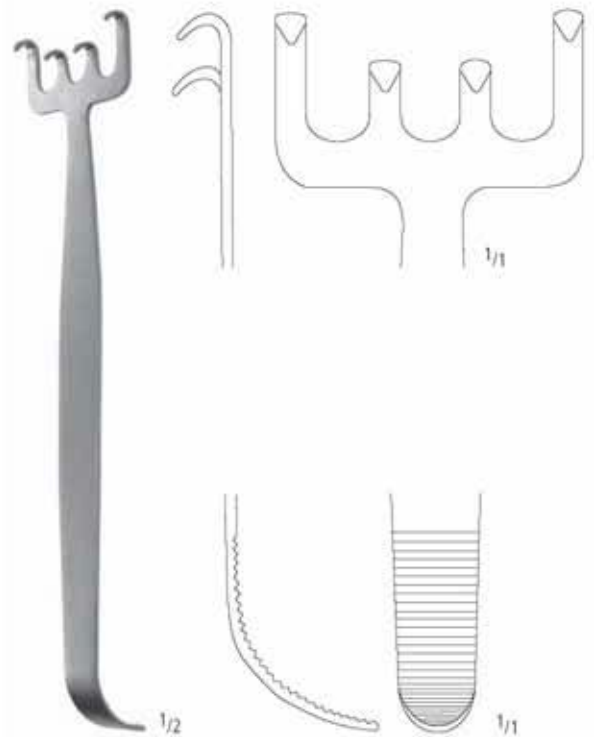

WALTER
AK 128/19
19,0 cm/7¹/₂"

FACELIFTING FACELIFTING LIFTING FACIAL LIFTING FACIAL LIFTING FACCIALE



KOCHER-LANGENBECK
AK 233/06
21,5 cm/8 1/2"



FARABEU
AK 354/00
15,0 cm/6"



AO 501/12



20,0 cm/8"
Ø 3 mm

neck lift

rhino basic

rhino advanced

otoplasty

facelift

facelift endoscopy

blepharoplasty

hair transplantation

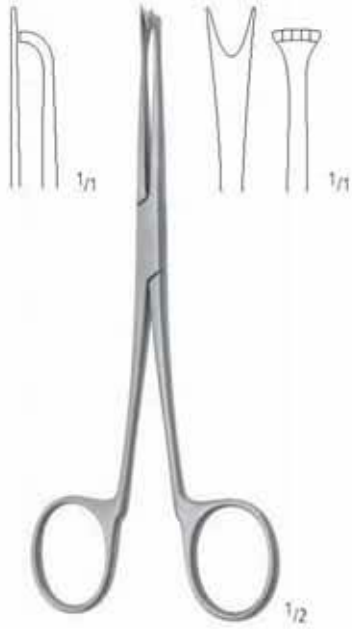

AR 297/16
16,0 cm/6¹/₄"



HARTMANN
KL 114/15
15,0 cm/6"



KYE 302/05 **L(mm)** **B(mm)** **H(mm)**
255 245 50



KYE 810/03 **L(mm)** **B(mm)**
300 300

ENDOSKOPISCHES FACELIFTING
ENDOSCOPIC FACELIFTING
LIFTING FACIAL ENDOSCOPICO
LIFTING FACIAL ENDOSCOPIE
LIFTING FACCIALE ENDOSCOPICO

SET ZS 207/02

Siebvorschlag - Suggested instrument set



FACELIFTING FACELIFTING LIFTING FACIAL LIFTING FACIAL LIFTING FACCIALE

ZS 207/02	Content:	Qty
AC 971/18SC	METZENBAUM-DELICATE SCISSORS, TUC, CVD, BL 18,0 CM, SC	1
AE 434/15	MICRO-RYDER NEEDLE HOLDER, TUC, 15,0 CM	1
AE 470/15	CRILE-WOOD NEEDLE HOLDER, TUC, 15,0 CM	1
AK 451/10	FERREIRA FACE LIFT RETRACTOR WITH FIBROPTIC ILLUMINATION	1
AK 453/20	OPTICAL RETRACTOR	1
KA 680/13	WILLIGER RASPATORY, STRAIGHT, 13,0 CM	1
KA 680/16	WILLIGER RASPATORY, STRAIGHT, 16,0 CM	1
KA 689/05	SEMB RIB RASPATORY, FIG.5, 20,5 CM	1
KA 690/08	LANGENBECK ELEVATOR, CURVED, 19,5 CM	1
KA 702/19	FREER SEPTUM ELEVATOR, BLUNT, 19,0 CM	1
KA 704/15	HOEN ELEVATOR, 19,0 CM	1
K0 315/00	BRUENINGS KNIFE, 16,0 CM	1
XM 010/00	HANDLE INSULATED ROTATABLE	1
XM 014/00	HANDLE WITH RATCHET ROTATABLE WITH STOP	1
XM 020/18	TUBE, 5MM, 18,0 CM	1
XM 138/18	METZENBAUM SCISSORS, STRAIGHT, 5MM, 18,0 CM	1
XM 139/18	METZENBAUM SCISSORS, CURVED, 5MM, 18,0 CM	1
XM 170/18	DOLPHIN GRASPING FORCEPS, 5MM, 18,0 CM	1
XP 701/43	OPTIC, 4,0 MM, 30°	1
KYE 300/05	WIRE BASKET, 485 x 255 x 50 MM	1
KYE 401/29	ENDOSCOPY WIRE BASKET 290 x 80 x 52 MM	1
KYE 810/02	SILICON MAT, 225 x 225 MM	2

Sterilizing Container KYE 200/51, if required.

FACELIFTING FACELIFTING LIFTING FACIAL LIFTING FACIAL LIFTING FACCIALE

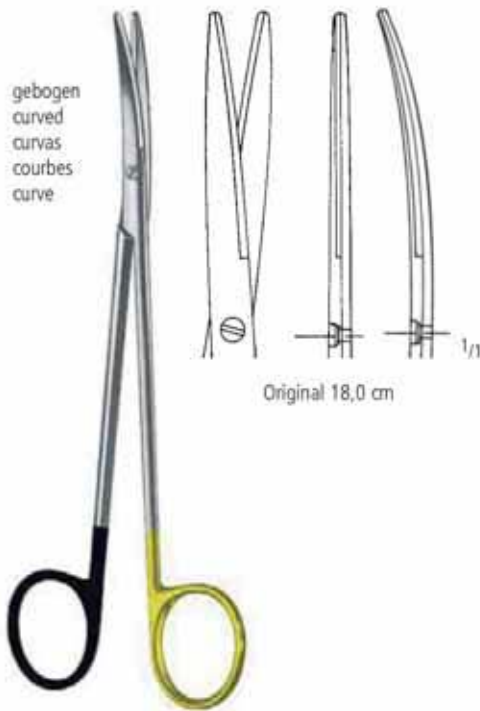

METZENBAUM-DELICATE
AC 971/18 SC
18,0 cm/7"



MICRO RYDER
AE 434/15
15,0 cm/6"



CRILE-WOOD
AE 470/15
15,0 cm/6"



Wundhaken mit Kaltlichtbeleuchtung
Retractor with fibreoptic illumination



neck lift
rhino basic
rhino advanced
otoplasty
facelift
facelift endoscopy
blepharoplasty
hair transplantation



WILLIGER
KA 680/13
13,0 cm/5"



WILLIGER
KA 680/16
16,0 cm/6 1/4"



SEMB
KA 689/05
20,5 cm/8"

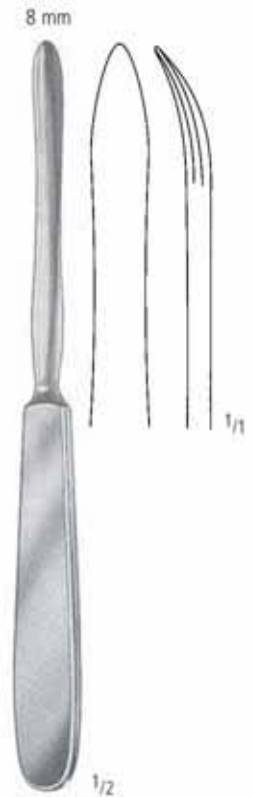

LANGENBECK
KA 690/08
19,5 cm/7 3/4"



FREER
KA 702/19
19,0 cm/7 1/2"



HOEN
KA 704/15
19,0 cm/7 1/2"



BRUENINGS
KO 315/00
16,0 cm/6 1/4"

easyClean[®]



XM 010/00



XM 014/00

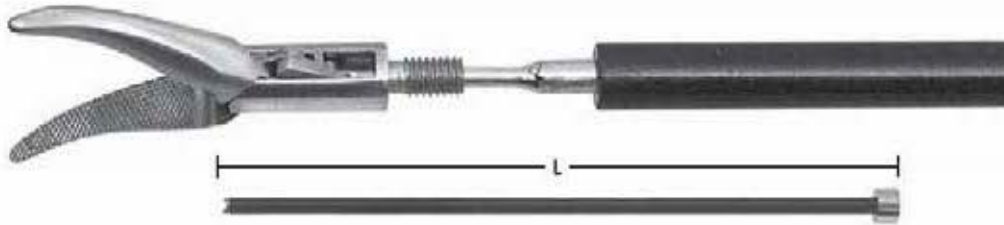

Ø 5,0 mm L 18,0 cm/7" XM 020/18

>> maximum precision and quality standards

Ordering information: Please order handle, tube and working tip.

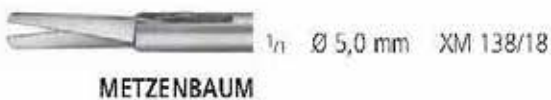

METZENBAUM

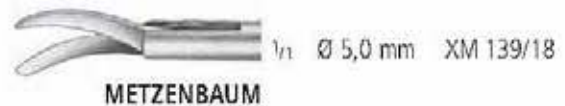

METZENBAUM

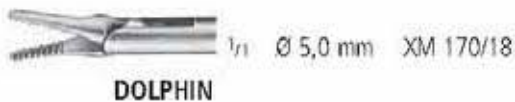

DOLPHIN

neck lift

rhino basic

rhino advanced

otoplasty

face lift

face lift endoscopy

blepharoplasty

hair transplantation

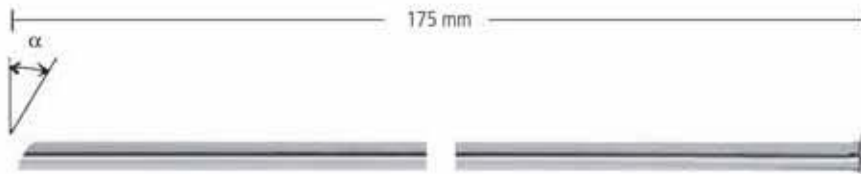

>> autoclavable

>> with adaptors for

Storz
Wolf
ACMI

Ø mm
4,0

$\alpha = 30^\circ$
XP 701/43



KYE 300/05

L(mm)	B(mm)	H(mm)
485	255	50



KYE 401/29

L(mm)	B(mm)	H(mm)
290	80	52



Mit Silikonfixierungen
with silicon fixation



KYE 810/02

L(mm)	B(mm)
225	225

AUGENLIDPLASTIK
BLEPHAROPLASTY
BLEPHAROPLASTIA
BLEPHAROPLASTIE
BLEFAROPLASTICA

SET

ZS 209/01

Siebvorschlag - Suggested instrument set



ZS 209/01	Content:	Qty
AA 150/12	HALSTED-MOSQUITO ARTERY FORCEPS, STRAIGHT, 12,5 CM	1
AA 151/12	HALSTED-MOSQUITO ARTERY FORCEPS, CURVED, 12,5 CM	1
AA 751/08	BACKHAUS TOWEL FORCEPS, 8,0 CM	4
AB 116/07	ADSON-BROWN TISSUE FORCEPS, 7X7 T., STRAIGHT, 12,0 CM	1
AB 130/12	SEMKEN TISSUE FORCEPS, 1X2 T., STRAIGHT, 12,5 CM	1
AC 910/14SC	MAYO DISSECTING SCISSORS, TUC, BL/BL, SC, STRAIGHT, 14,5 CM	1
AC 974/11SC	STEVENS TENOTOMY SCISSORS, TUC, STRAIGHT, 11,5 CM	1
AC 975/11SC	STEVENS TENOTOMY SCISSORS, TUC, CURVED, 11,5 CM	1
AD 010/03	SCALPEL HANDLE NO.3	2
AD 075/10	PCK=100 SCALPEL BLADES, FIG.10	1
AE 466/13	HALSEY NEEDLE HOLDER, TUC, 13,0 CM	1
AK 020/01	GILLIES DELICATE HOOK, FIG.1, 18,0 CM	1
AK 051/03	RETRACTOR SEMI-SHARP, 3 PRONGS, 16,0 CM	1
AK 072/05	JOSEPH DELICATE HOOK, 16,0 CM	1
KU 300/11	MIXING BOWL, 116 x 50 MM	1
XR 830/03	CONNECTION CORD BIPOLAR, 300 CM	1
XR 894/16E	BI-COAGULATION-FORCEPS NEEDLE, 16,0 CM	1
KYE 302/03	WIRE BASKET, 255 x 245 x 50 MM	1
KYE 810/03	SILICON MAT, 300 x 300 MM	1

Sterilizing Container KYE 200/01, if required.



HALSTED-MOSQUITO
AA 150/12 AA 151/12
12,5 cm/5"



BACKHAUS
AA 751/08
8,0 cm/3"



ADSON-BROWN
AB 116/07
12,0 cm/4³/₄"



SEMKEN 1:2
AB 130/12
12,5 cm/5"

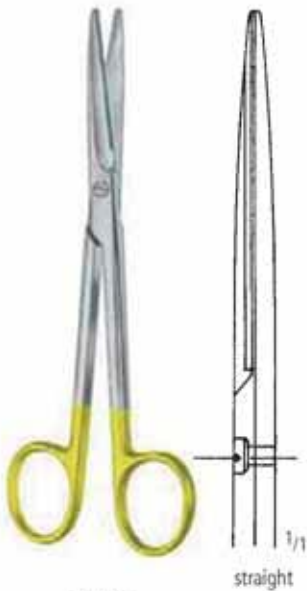

MAYO
AC 910/14 SC
14,5 cm/5¹/₂"



STEVENS
AC 974/11SC AC 975/11SC
11,5 cm/4¹/₂"

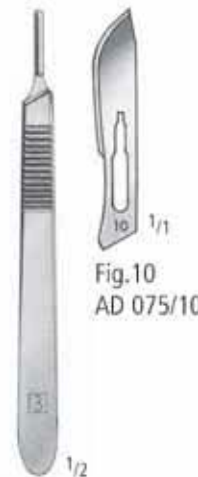

AD 010/03
No. 3



HALSEY
AE 466/13
13,0 cm/5"

neck lift

rhino basic

rhino advanced

otoplasty

facelift

facelift endoscopy

blepharoplasty

hair transplantation



GILLIES
AK 020/01
18,0 cm/7"



AK 051/03
16,0 cm/6 1/4"



JOSEPH
AK 072/05
16,0 cm/6 1/4"



KU 300/11
Ø x h
116 x 50 mm 0,35 l

bipolar
Connecting cable



MARTIN / BERCHTHOLD
XR 830/03
300 cm



XR 894/16E
16,0 cm/6 1/4"



KYE 302/03	L(mm)	B(mm)	H(mm)
	255	245	30



KYE 810/03	L(mm)	B(mm)
	300	300

neck lift

rhino basic

rhino advanced

otoplasty

facelift

facelift endoscopy

blepharoplasty

hair transplantation

HAARTRANSPLANTATION
HAIR TRANSPLANTATION
TRANSPLANTE DE CABELLO
GREFFE DES CHEVEUX
TRAPIANTO CAPELLI

SET

ZS 210/01

Siebvorschlag - Suggested instrument set



ZS 210/01	Content:	Qty
AA 151/12	HALSTED-MOSQUITO ARTERY FORCEPS, CURVED, 12,5 CM	1
AB 060/13	STANDARD TISSUE FORCEPS, 1X2 T., STRAIGHT, 13,0 CM	1
AB 083/13	DRESSING FORCEPS, DELICATE, 13,0 CM	1
AB 084/13	TISSUE FORCEPS 1X2 T., DELICATE, 13,0 CM	1
AB 120/12	SEMKEN DRESSING FORCEPS, STRAIGHT, 12,5 CM	1
AB 501/45	JEWELER'S FORCEPS, NO.5/45°, 10,5 CM	1
AB 983/02	PERRY COTTON AND DRESSING PLIER, FIG.2, 12,5 CM	1
AC 960/14	METZENBAUM-DELIC. TUC, STR, BL/BL, 14,5 CM	1
AD 010/03	SCALPEL HANDLE NO.3	2
AD 065/13	SCALPEL HANDLE MINI, 13,0 CM	1
AD 065/63	PCK=10 MINI SCALPEL BLADES, FIG.62S	1
AD 065/64	PCK=10 MINI SCALPEL BLADES, FIG.64	1
AD 065/65	PCK=10 MINI SCALPEL BLADES, FIG.65	1
AD 065/67	PCK=10 MINI SCALPEL BLADES, FIG.67	1
AD 075/10	PCK=100 SCALPEL BLADES, FIG.10	1
AD 075/11	PCK=100 SCALPEL BLADES, FIG.11	1
AD 075/15	PCK=100 SCALPEL BLADES, FIG.15	1
AE 452/12	CONVERSE NEEDLE HOLDER, TUC, 12,5 CM	1
AO 875/02	DISPOSABLE PLASTIC SYRINGE, 20 ML	1
KU 325/18	METAL COMB, 18,0 CM	1
KYE 304/50	WIRE BASKET, 267 x 125 x 50 MM	1
KYE 810/01	SILICON MAT, 275 x 125 MM	1

Sterilizing Container KYE 351/01, if required.



HALSTED-MOSQUITO
AA 151/12
12,5 cm/5"

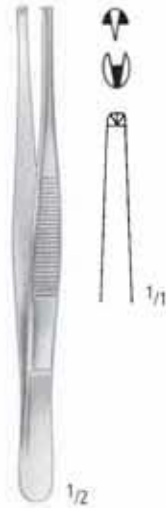

STANDARD 1:2
AB 060/13
13,0 cm/5"

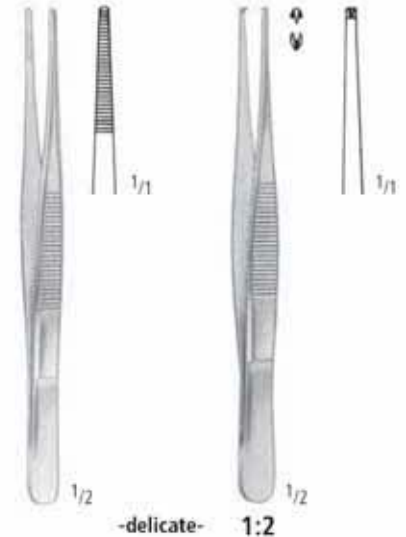

AB 083/13
13,0 cm/5"

AB 084/13
13,0 cm/5"



SEMKEN
AB 120/12
12,5 cm/5"



No. 5/45°
AB 501/45
10,5 cm/4 1/4"

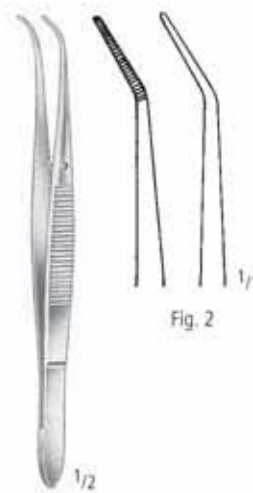

PERRY
AB 983/02
12,5 cm/5"



METZENBAUM-DELICATE
AC 960/14
14,5 cm/5 3/4"

neck lift

rhino basic

rhino advanced

otoplasty

facelift

facelift endoscopy

blepharoplasty

hairtransplantation

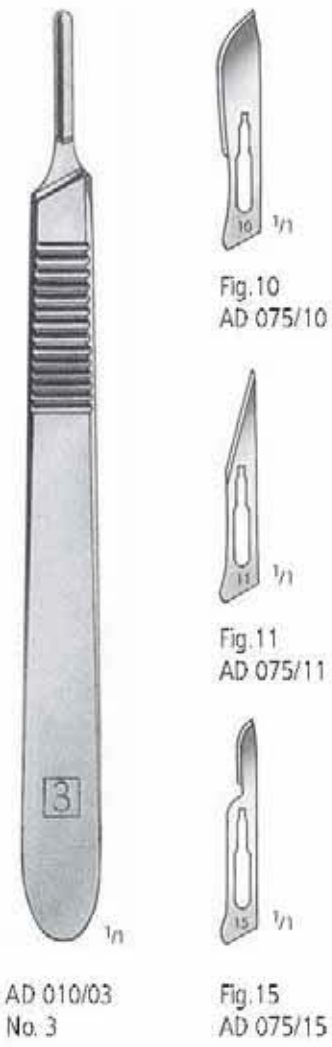

MINI

packing unit = 10 St./pc.

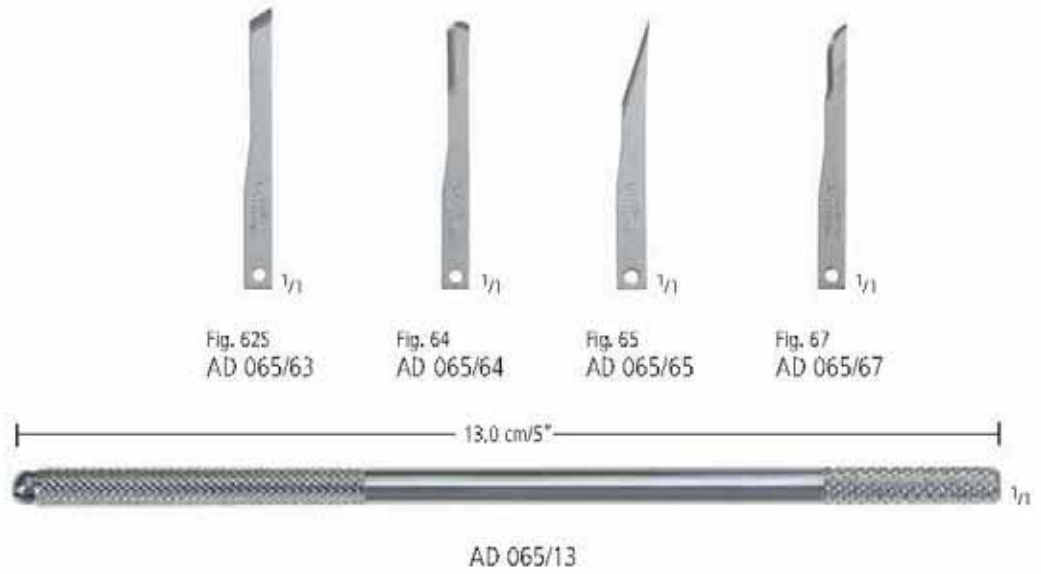



KYE 304/50

L(mm)	B(mm)	H(mm)
267	125	50



KYE 810/01

L(mm)	B(mm)
275	125

neck lift

rhino basic

rhino advanced

otoplasty

face lift

facelift endoscopy

blepharoplasty

hair transplantation

KLEMMEN
HEMOSTATS
PINZAS HEMOSTATICAS
PINCES HEMOSTATIQUES
PINZE EMOSTATICHE

AA

nopa[®] instruments

Weitere Klemmen finden Sie in unserem Katalog „Allgemeines Instrumentarium“ in Gruppe AA.

For further hemostats kindly refer to our catalogue "General Instruments", section AA.

Para pinzas hemostaticas adicionales, por favor consulte nuestro catálogo de "Instrumental de uso general", grupo AA.

Pour des pinces hemostatiques supplémentaires, consultez notre catalogue „Instrumentation Generale“, section AA.

Per gli altri pinze emostatiche, consultare il nostro catalogo "Strumentazione Generale", gruppo AA.



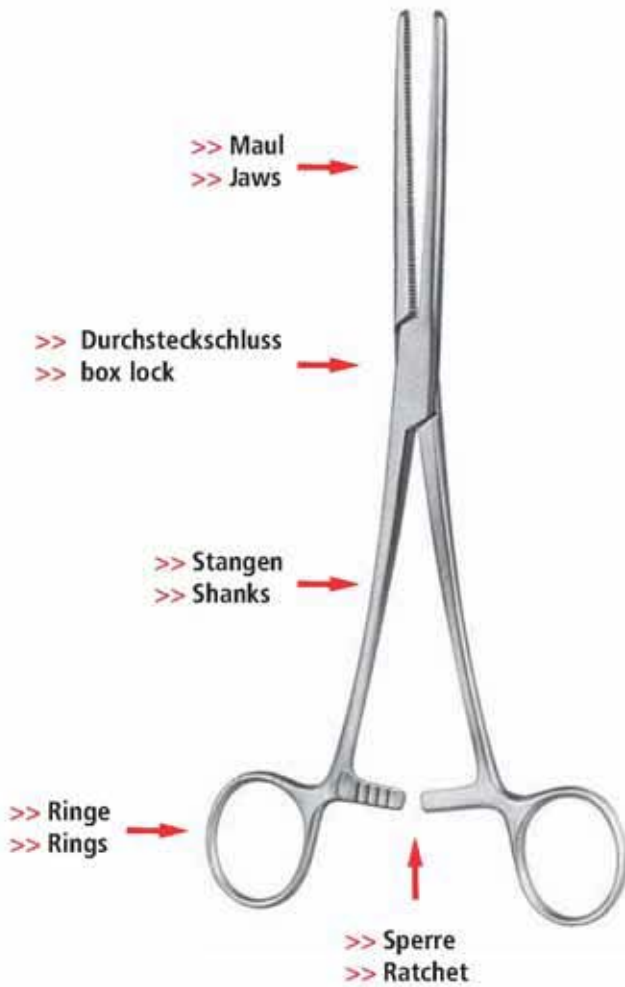

>> Spitzen
>> Tips



>> ohne Zähne
>> without teeth



>> mit Zähnen 1:2
>> with teeth 1:2

>> Maulbiegung
>> jaw curvature



>> gerade
>> straight



>> gebogen
>> curved

>> Riefung
>> serrations



>> quer
>> horizontal



>> längs
>> longitudinal



>> kreuz
>> cross

Gewebefasszängchen
Tissue Seizing Forceps
Pinzas para coger tejidos
Pincers pour saisir le tissu
Pinze per afferrare tessuti

AA

AB

AC

AD

AE

AF

AK

AL

AO

AP

AR

KA

KL

KM

KO

KU

KYE

X



ALLIS 4:5
KD 054/15
15,0 cm/6"



ALLIS 5:6
15,0 cm/6" KD 055/15
19,0 cm/7 1/2" KD 055/19
25,0 cm/10" KD 055/25



BABCOCK



KD 111/16
16,0 cm/6 1/4"



KD 111/18
18,0 cm/7"

AA KLEMMEN HEMOSTATS PINZAS HEMOSTATICAS PINCES HEMOSTATIQUES PINZE EMOSTATICHE

Bulldogklemmen
Bulldog Clamps
Clamps Bulldog
Clamps Bulldog
Pinze Bulldog

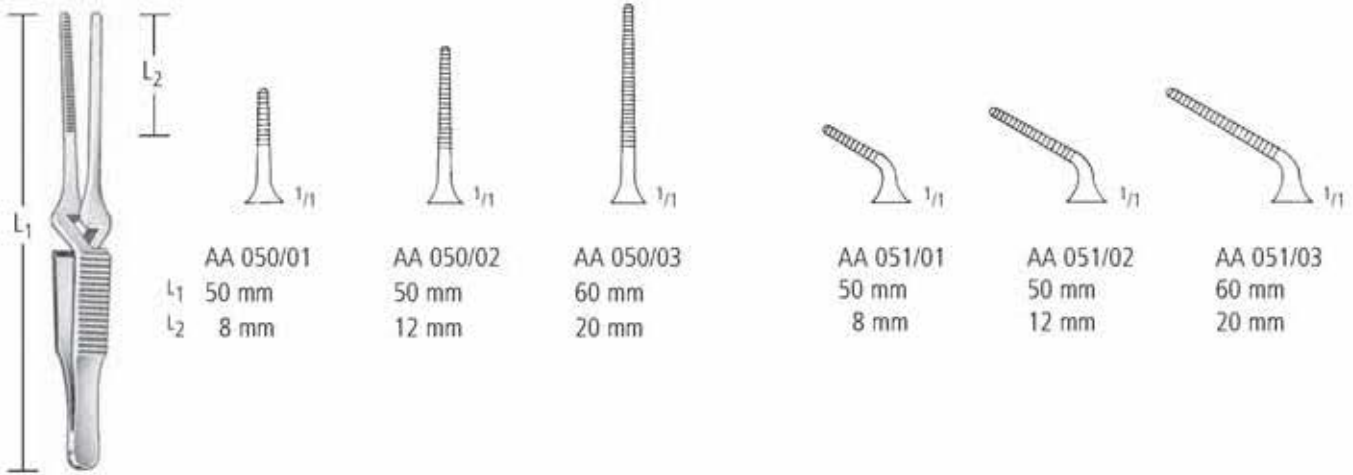

AA 050/01
L₁ 50 mm
L₂ 8 mm

AA 050/02
50 mm
12 mm

AA 050/03
60 mm
20 mm

AA 051/01
50 mm
8 mm

AA 051/02
50 mm
12 mm

AA 051/03
60 mm
20 mm

3 gr. Gewicht
50 gr. Druck
Gewicht Pressure
Weight Pression
Peso Presión
Poids Pression
Peso Pressione

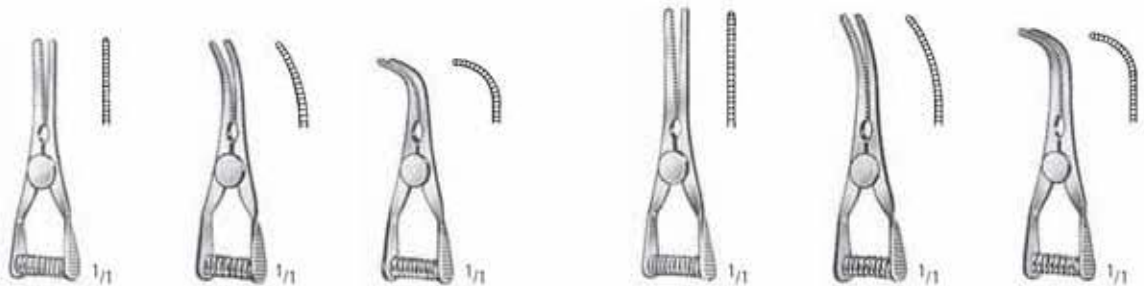

**VENA
ARTERIA**

AA 052/01
AA 053/01

TITAN 30 mm
AA 052/02
AA 053/02

AA 052/03
AA 053/03

AA 054/01
AA 055/01

TITAN 35 mm
AA 054/02
AA 055/02

AA 054/03
AA 055/03

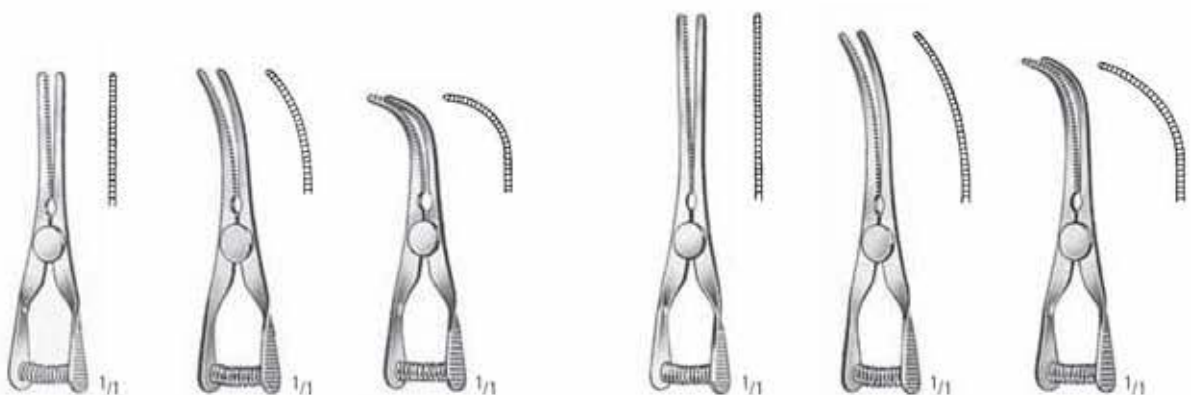

**VENA
ARTERIA**

AA 056/01
AA 057/01

TITAN 40 mm
AA 056/02
AA 057/02

AA 056/03
AA 057/03

AA 058/01
AA 059/01

TITAN 50 mm
AA 058/02
AA 059/02

AA 058/03
AA 059/03

Bulldogklemmen, Anlegezange
 Bulldog Clamps, Setting Forceps
 Clamps Bulldog, Pinza para poner
 Clamps Bulldog, Pince à poser
 Pinze Bulldog, Pinza per posizionare

AA
 AB
 AC
 AD
 AE
 AF
 AG
 AH
 AI
 AJ
 AK
 AL
 AM
 AN
 AO
 AP
 AQ
 AR
 AS
 AT
 AU
 AV
 AW
 AX



DIEFFENBACH

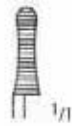

AA 060/03
3,5 cm/1 1/2"

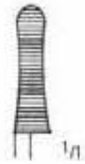

AA 060/05
5,0 cm/2"

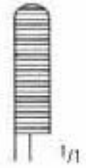

AA 060/06
6,0 cm/2 1/2"



AA 061/03
3,5 cm/1 1/2"

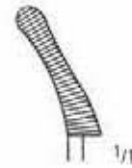

AA 061/05
5,0 cm/2"



AA 061/06
6,0 cm/2 1/2"



JOHNS-HOPKINS
 AA 069/24
 24,5 cm/9 3/4"



JOHNS-HOPKINS



AA 070/04
4,0 cm/1 1/2"



AA 070/05
5,0 cm/2"

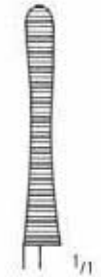

AA 070/06
6,5 cm/2 1/2"



AA 070/07
7,5 cm/3"



AA 070/09
9,0 cm/3 1/2"



AA 071/04
4,0 cm/1 1/2"



AA 071/05
5,0 cm/2"

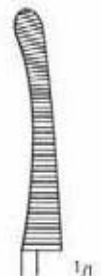

AA 071/06
6,5 cm/2 1/2"

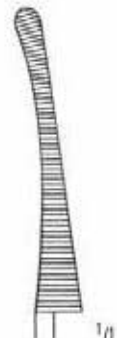

AA 071/07
7,5 cm/3"

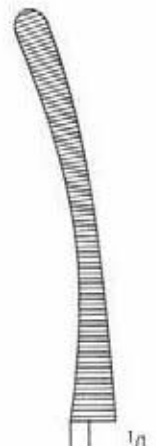

AA 071/09
9,0 cm/3 1/2"

Fasszangen
Seizing Forceps
Pinzas para coger
Pinces à saisir
Pinze per afferrare

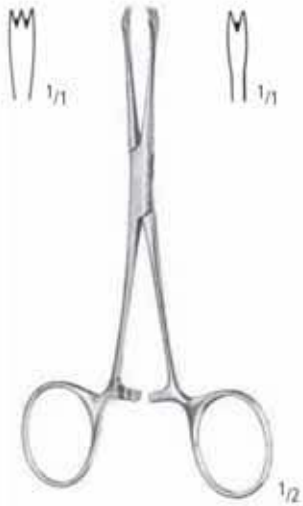

CHAPUT
AA 072/02
13,0 cm/5"



TUFFIER
AA 072/04
13,0 cm/5"

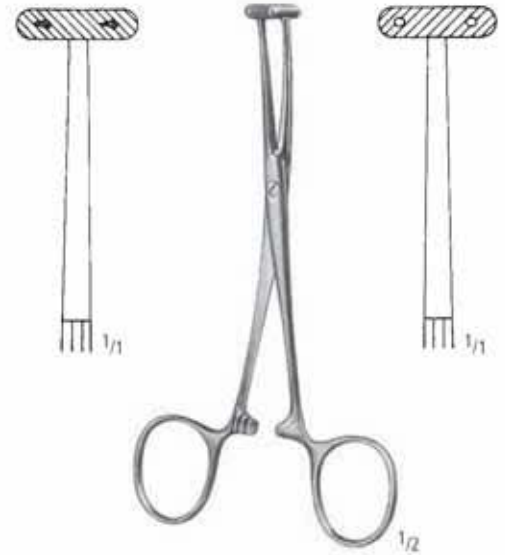

MARTEL
AA 078/14
14,0 cm/5 1/2"



PEAN
14,0 cm/5 1/2" AA 080/14
16,0 cm/6 1/4" AA 080/16



AA 080/14



AA 080/16



KROENLEIN
AA 082/13
13,0 cm/5"

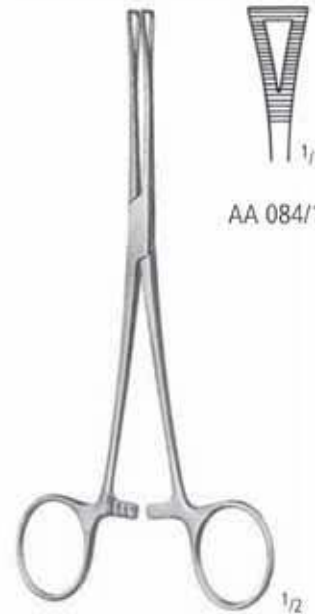

PENNINGTON
AA 084/15
15,5 cm/6"

AA 084/15

Arterienklemmen
 Artery forceps
 Pinzas hemostáticas
 Pincès hémostatiques
 Pinze emostatiche

AA
 AB
 AC
 AD
 AE
 AF
 AK
 AL
 AO
 AP
 AR
 KA
 KL
 KM
 KO
 KU
 KYE
 X



SPENCER-WELLS

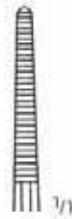

AA 110/13
 13,0 cm/5"

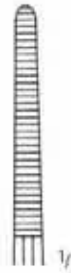

AA 110/14
 14,0 cm/5½"

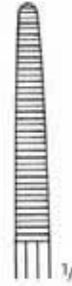

AA 110/15
 15,5 cm/6"

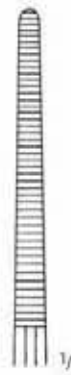

AA 110/18
 18,0 cm/7"

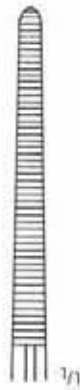

AA 110/20
 20,0 cm/8"



AA 111/13
 13,0 cm/5"



AA 111/14
 14,0 cm/5½"

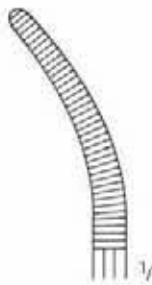

AA 111/15
 15,5 cm/6"



AA 111/18
 18,0 cm/7"

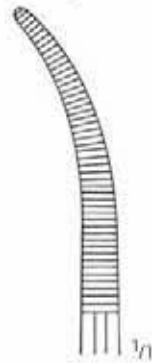

AA 111/20
 20,0 cm/8"



HARTMANN
 AA 114/10
 10,0 cm/4"



HARTMANN
 AA 115/10
 10,0 cm/4"



CARREL
 AA 116/08
 8,5 cm/3½"

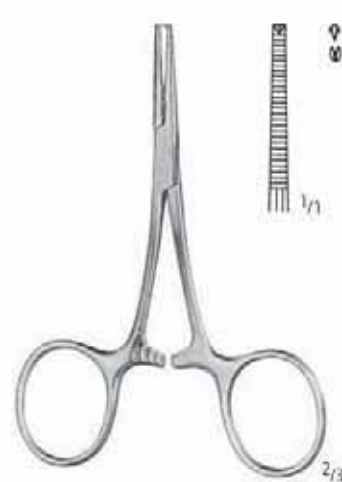

TERRIER 1:2
 AA 118/08
 8,5 cm/3½"

Feine Arterienklemmen
 Fine Artery Forceps
 Pinzas hemostáticas finas
 Pincas hémostatiques fines
 Pinze emostatiche fine

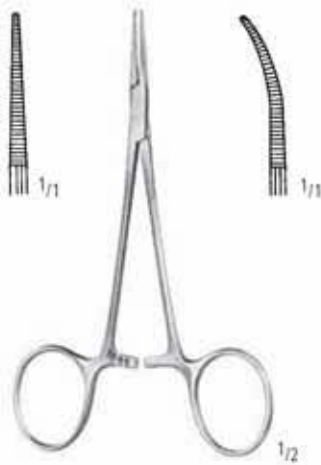

MICRO-MOSQUITO

AA 130/10 AA 131/10
 AA 130/12 AA 131/12

10,0 cm/4"
 12,0 cm/4³/₄"

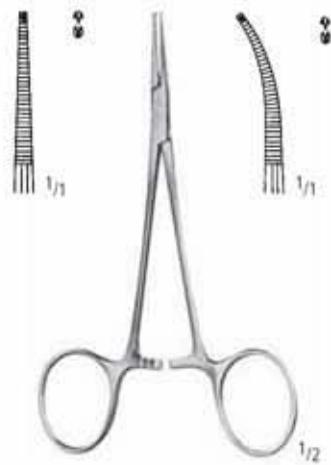

MICRO-MOSQUITO 1:2

AA 132/10 AA 133/10
 AA 132/12 AA 133/12

WILLIAM STEWART HALSTED

was professor of surgery in the Johns Hopkins University. In 1890 he had bronze casts made of his own hands. On these casts the first surgical rubber gloves were moulded.



HALSTED-MOSQUITO

AA 150/12 AA 151/12
 AA 150/14 AA 151/14

12,5 cm/5"
 14,0 cm/5¹/₂"

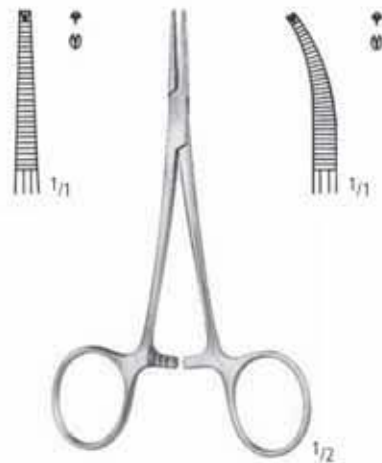

HALSTED-MOSQUITO 1:2

AA 152/12 AA 153/12
 AA 152/14 AA 153/14

Arterienklemmen
 Artery forceps
 Pinzas hemostáticas
 Pincés hémostatiques
 Pinze emostatiche

AA
 AB
 AC
 AD
 AE
 AF
 AK
 AL
 AO
 AP
 AR
 KA
 KL
 KM
 KO
 KU
 KYE
 X

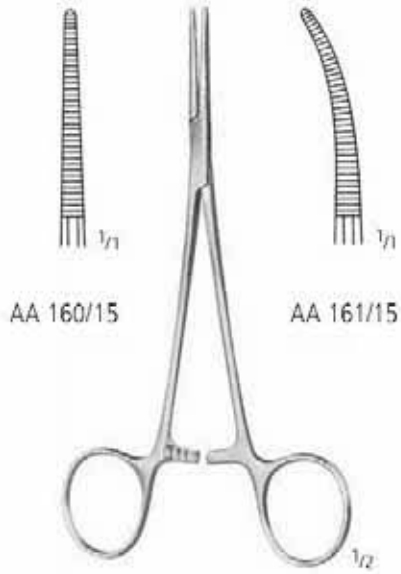

LERICHE
 15,0 cm/6"

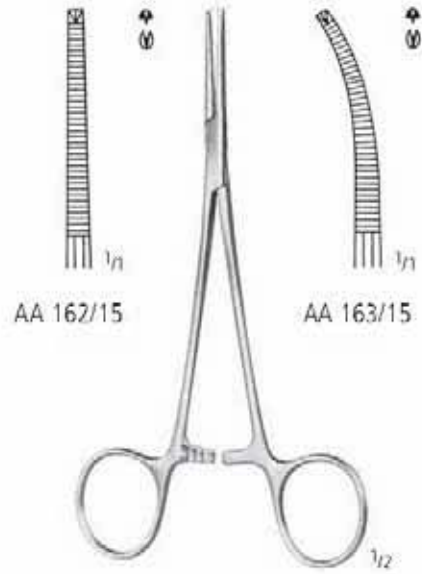

LERICHE 1:2
 15,0 cm/6"

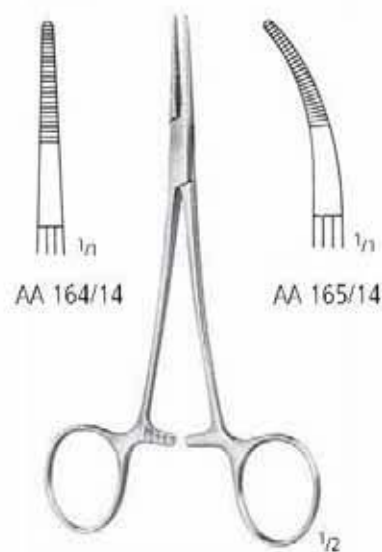

PROVIDENCE-HOSPITAL
 14,0 cm/5 1/2"

Arterienklemmen
 Artery Forceps
 Pinzas hemostáticas
 Pincas hémostatiques
 Pinze emostatiche

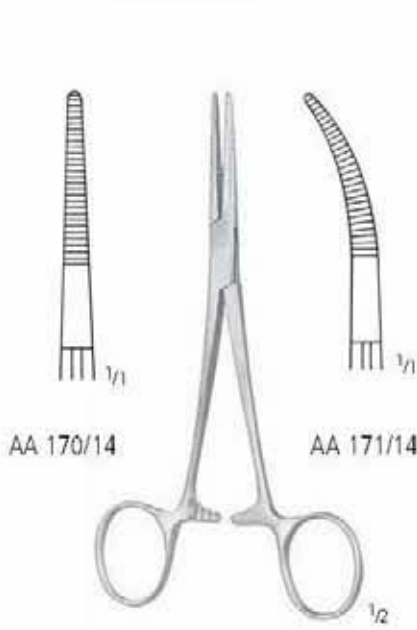

KELLY
 14,0 cm/5 1/2"

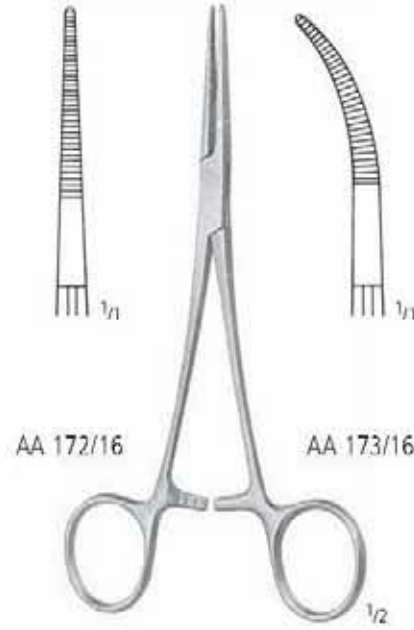

KELLY-RANKIN
 16,0 cm/6 1/4"

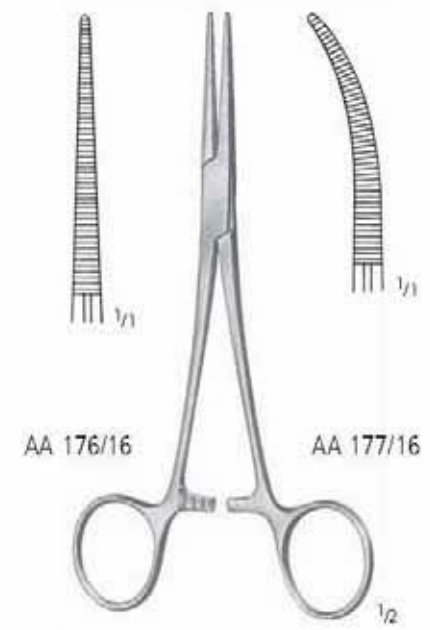

COLLER
 AA 176/14 14,0 cm/5 1/2" AA 177/14
 AA 176/16 16,0 cm/6 1/4" AA 177/16

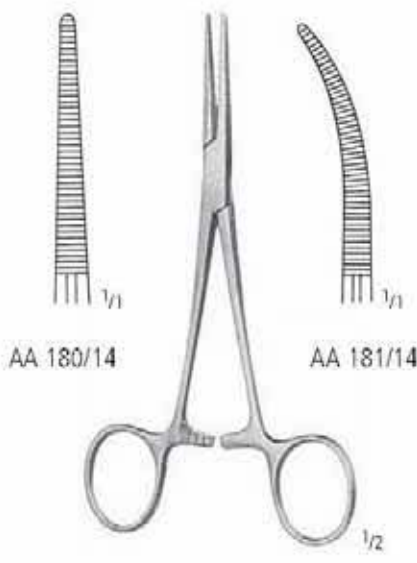

CRILE
 14,0 cm/5 1/2"

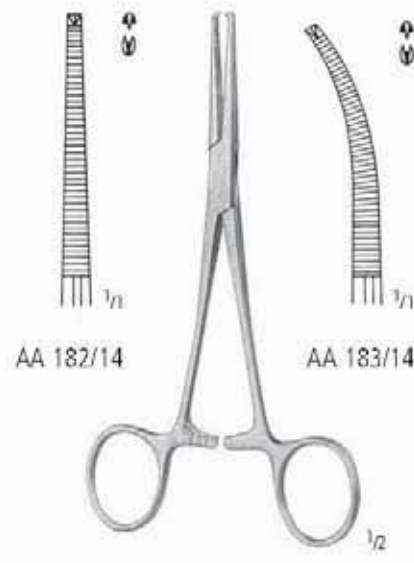

CRILE 1:2
 14,0 cm/5 1/2"

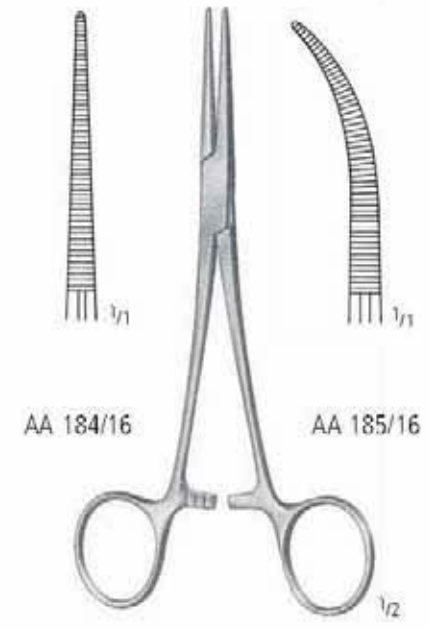

CRILE-RANKIN
 16,0 cm/6 1/4"

Arterienklemmen
 Artery forceps
 Pinzas hemostáticas
 Pincés hémostatiques
 Pinze emostatiche

AA
 AB
 AC
 AD
 AE
 AF
 AK
 AL
 AO
 AP
 AR
 KA
 KL
 KM
 KO
 KU
 KYE
 X



ROCHESTER-PEAN

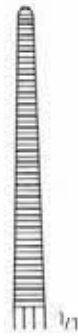

AA 200/14
 14,0 cm/5 1/2"

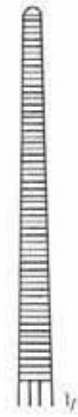

AA 200/16
 16,0 cm/6 1/4"

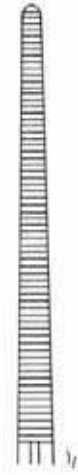

AA 200/18
 18,0 cm/7"

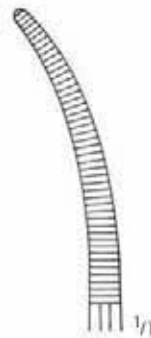

AA 201/14
 14,0 cm/5 1/2"



AA 201/16
 16,0 cm/6 1/4"

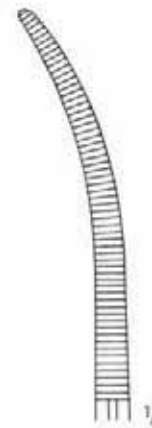

AA 201/18
 18,0 cm/7"

Arterienklemmen
 Artery Forceps
 Pinzas hemostáticas
 Pincas hémostatiques
 Pinze emostatiche



OCHSNER-KOCHER 1:2

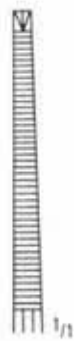

AA 210/14
 14,0 cm/5¹/₂"



AA 210/16
 16,0 cm/6¹/₄"

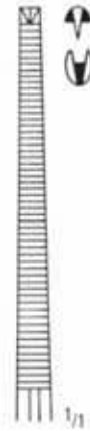

AA 210/18
 18,0 cm/7"



AA 211/14
 14,0 cm/5¹/₂"



AA 211/16
 16,0 cm/6¹/₄"

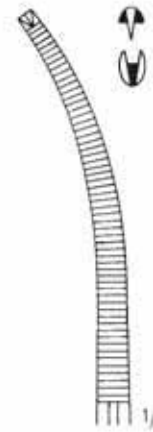

AA 211/18
 18,0 cm/7"

Grazile Arterienklemmen
Delicate Artery Forceps
Pinzas hemostáticas delgadas
Pinces hémostatiques grâciles
Pinze emostatiche delicate

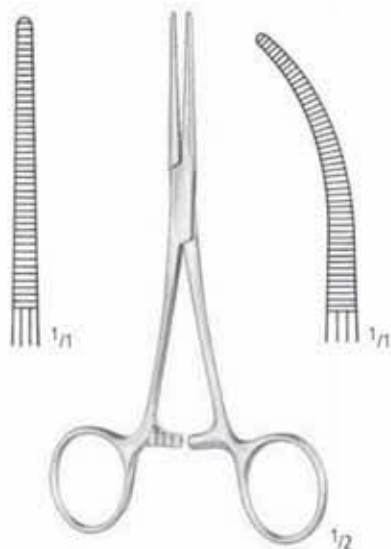

PEAN - DELICATE

AA 214/13	AA 215/13
AA 214/14	AA 215/14
AA 214/16	AA 215/16

JULES PEAN, born 1830, died 1898, was the most important French gynecological surgeon of his time. He studied at Paris 1860. 1864 Pean was the first surgeon in Paris to perform an ovariectomy. By the use of Pean pins he introduced forceps pressure for control of hemorrhage, thus he invented the most used surgical instrument, next to the scalpel.

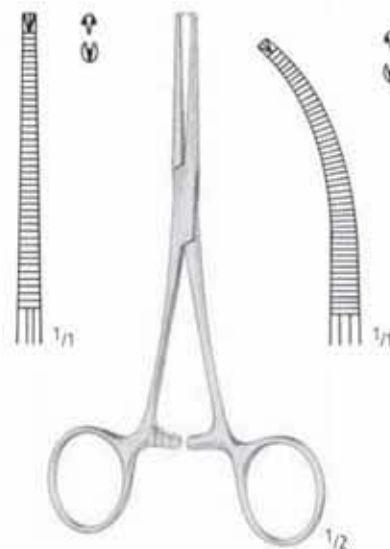

KOCHER 1:2 - DELICATE

AA 216/13	AA 217/13
AA 216/14	AA 217/14
AA 216/16	AA 217/16

ALBERT J. OCHSNER, born 1858, died 1925. He devoted much time to attending and participating in medical discussions and was member of all leading societies in his fields.

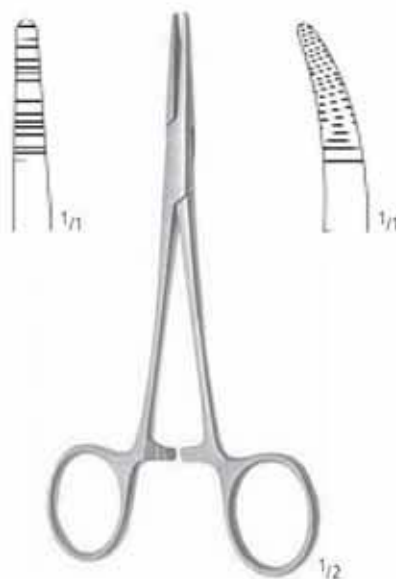

CAIRNS

AA 218/15	15,0 cm/6"	AA 219/15
-----------	------------	-----------



DUNHILL

AA 220/13	13,0 cm/5"
-----------	------------

AA
AB
AC
AD
AE
AF
AK
AL
AO
AP
AR
KA
KL
KM
KO
KU
KYE
X

Arterienklemmen, Kopfhautklemmen
 Artery Forceps, Scalp Flap Forceps
 Pinzas hemostáticas, Pinzas hemostáticas para pericráneo
 Pincés hémostatiques, Pincés hémostatiques pour le cuir chevelu
 Pinze emostatiche, Pinze emostatiche per il cuoio capelluto



DIXON-LOVELACE
 AA 286/15
 15,5 cm/6"



DIXON-LOVELACE 1:2
 AA 288/15
 15,5 cm/6"



DANDY
 AA 291/14
 14,0 cm/5 1/2"

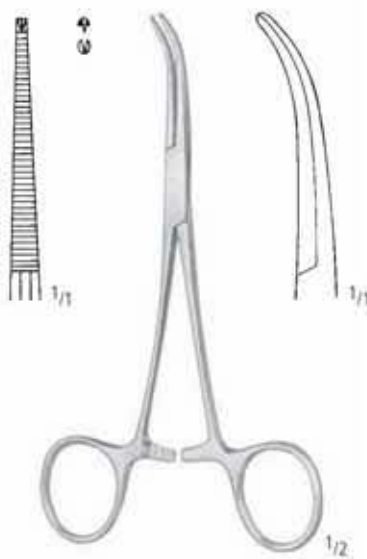

DANDY 1:2
 AA 293/14
 14,0 cm/5 1/2"

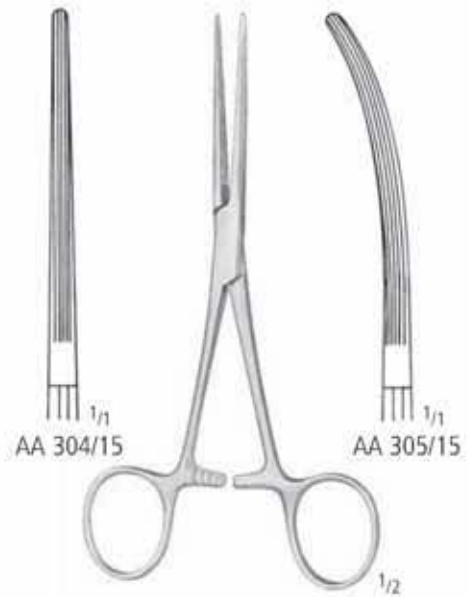

BAINBRIDGE
 AA 304/15 15,0 cm/6" AA 305/15
 AA 304/18 18,5 cm/7 1/3" AA 305/18

Präparier- und Ligaturklemmen
 Dissecting and Ligature Forceps
 Pinzas para preparaciones y ligaduras
 Pincas à dissection et à ligatures
 Pinze per preparazioni e legature

AA
 AB
 AC
 AD
 AE
 AF
 AG
 AH
 AI
 AJ
 AK
 AL
 AM
 AN
 AO
 AP
 AQ
 AR
 AS
 AT
 AU
 AV
 AW
 AX
 AY
 AZ



MIXTER
 15,5 cm/6"
 19,0 cm/7 1/2"
 AA 345/15
 AA 345/19

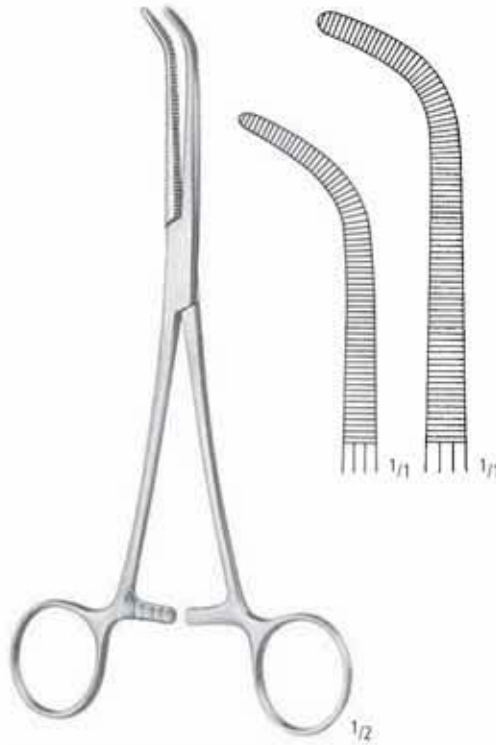

MIXTER-O'SHAUGNESSY
 15,5 cm/6"
 19,0 cm/7 1/2"
 AA 347/15
 AA 347/19

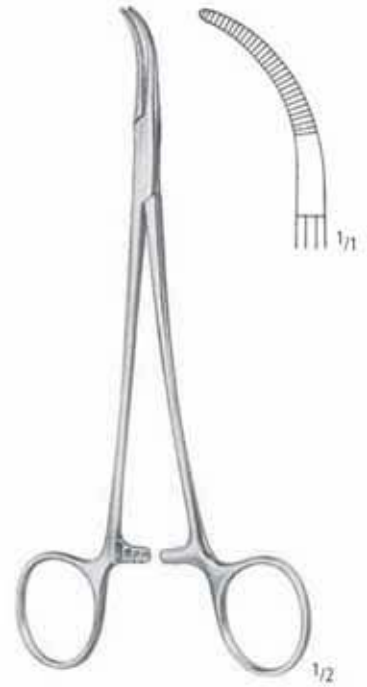

BABY-MIXTER
 AA 348/18
 18,0 cm/7"

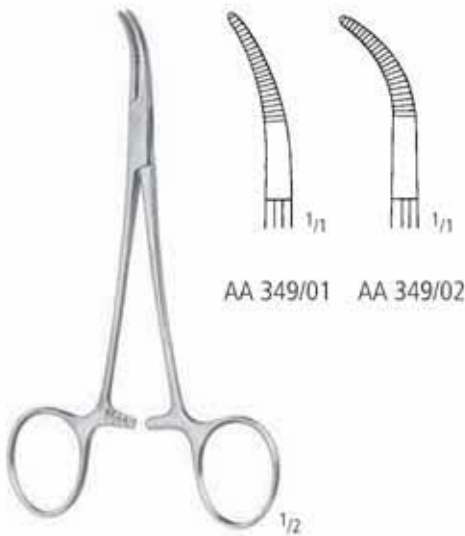

AA 349/01 AA 349/02

BABY-MIXTER
 14,0 cm/5 1/2"



GEMINI

AA 365/14
 14,0 cm/5 1/2"

AA 365/18
 18,0 cm/7"

Tuchklemmen
Towel Forceps
Pinzas de campo
Pincès à champs
Pinze per fissare le compresse (Fissatele)



SCHAEDEL
AA 710/09
9,0 cm/3 1/2"



JONES
5,0 cm/2"
9,0 cm/3 1/2"
AA 711/05
AA 711/09



ENGL. MODELL
AA 717/09
9,0 cm/3 1/2"



DOYEN
AA 721/18
18,0 cm/7"



BERNHARD
AA 726/16
16,5 cm/6 1/2"



LANE
15,0 cm/6"
18,0 cm/7"
20,0 cm/8"
AA 730/15
AA 730/18
AA 730/20

Tuchklemmen
Towel Forceps
Pinzas para compresas, Pinzas de campo
Pincés à champs, Pincés à compresse
Pinze per fissare le compresse (Fissatele)



AA 749/11

11,0 cm/4¹/₃"

- mit Schlauch- oder Kabelhalter
- with clip for tubing or cable
- con porta-tubo o porta-cable
- avec clamp porte-tube ou porte-corton d'alimentation
- con porta tubo o porta cavo

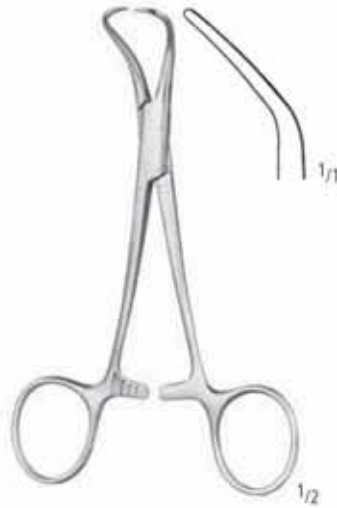

BACKHAUS

8,0 cm/3" AA 751/08
11,0 cm/4¹/₃" AA 751/11
13,0 cm/5" AA 751/13
15,0 cm/6" AA 751/15



BALL & SOCKET

11,0 cm/4¹/₃" AA 753/11
13,0 cm/5" AA 753/13

für Papiertücher
for paper tissues
para servilletas de papel
pour serviettes en papier
per tessuti di carta



ROEDER

13,0 cm/5" AA 761/13
15,0 cm/6" AA 761/15

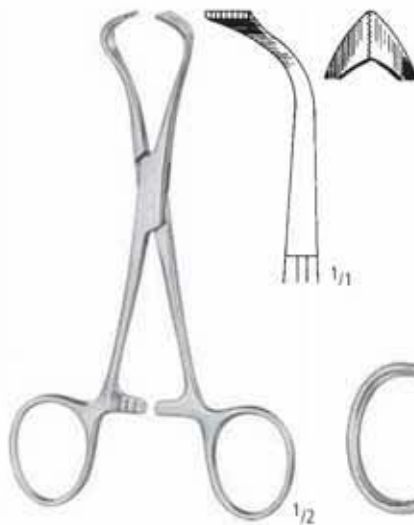

LORNA

10,0 cm/4" AA 763/10
13,0 cm/5" AA 763/13



TOHOKU-JAPAN

10,0 cm/4" AA 764/10
13,0 cm/5" AA 764/13

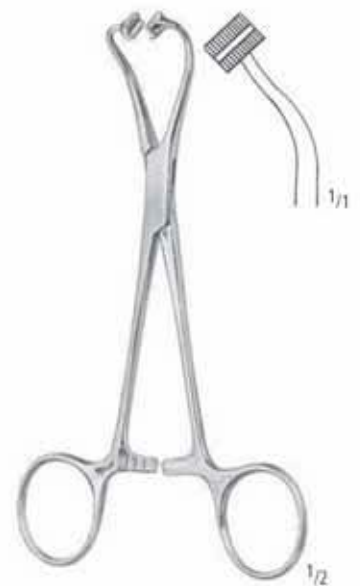

PEERS

AA 765/14
14,5 cm/5³/₄"

AA
AB
AC
AD
AE
AF
AG
AH
AI
AJ
AK
AL
AM
AN
AO
AP
AQ
AR
AS
AT
AU
AV
AW
AX
AY
AZ
BA
BB
BC
BD
BE
BF
BG
BH
BI
BJ
BK
BL
BM
BN
BO
BP
BQ
BR
BS
BT
BU
BV
BW
BX
BY
BZ
CA
CB
CC
CD
CE
CF
CG
CH
CI
CJ
CK
CL
CM
CN
CO
CP
CQ
CR
CS
CT
CU
CV
CW
CX
CY
CZ
DA
DB
DC
DD
DE
DF
DG
DH
DI
DJ
DK
DL
DM
DN
DO
DP
DQ
DR
DS
DT
DU
DV
DW
DX
DY
DZ
EA
EB
EC
ED
EE
EF
EG
EH
EI
EJ
EK
EL
EM
EN
EO
EP
EQ
ER
ES
ET
EU
EV
EW
EX
EY
EZ
FA
FB
FC
FD
FE
FF
FG
FH
FI
FJ
FK
FL
FM
FN
FO
FP
FQ
FR
FS
FT
FU
FV
FW
FX
FY
FZ
GA
GB
GC
GD
GE
GF
GG
GH
GI
GJ
GK
GL
GM
GN
GO
GP
GQ
GR
GS
GT
GU
GV
GW
GX
GY
GZ
HA
HB
HC
HD
HE
HF
HG
HH
HI
HJ
HK
HL
HM
HN
HO
HP
HQ
HR
HS
HT
HU
HV
HW
HX
HY
HZ
IA
IB
IC
ID
IE
IF
IG
IH
II
IJ
IK
IL
IM
IN
IO
IP
IQ
IR
IS
IT
IU
IV
IW
IX
IY
IZ
JA
JB
JC
JD
JE
JF
JG
JH
JI
JJ
JK
JL
JM
JN
JO
JP
JQ
JR
JS
JT
JU
JV
JW
JX
JY
JZ
KA
KB
KC
KD
KE
KF
KG
KH
KI
KJ
KK
KL
KM
KN
KO
KP
KQ
KR
KS
KT
KU
KV
KW
KX
KY
KZ
LA
LB
LC
LD
LE
LF
LG
LH
LI
LJ
LK
LL
LM
LN
LO
LP
LQ
LR
LS
LT
LU
LV
LW
LX
LY
LZ
MA
MB
MC
MD
ME
MF
MG
MH
MI
MJ
MK
ML
MM
MN
MO
MP
MQ
MR
MS
MT
MU
MV
MW
MX
MY
MZ
NA
NB
NC
ND
NE
NF
NG
NH
NI
NJ
NK
NL
NM
NN
NO
NP
NQ
NR
NS
NT
NU
NV
NW
NX
NY
NZ
OA
OB
OC
OD
OE
OF
OG
OH
OI
OJ
OK
OL
OM
ON
OO
OP
OQ
OR
OS
OT
OU
OV
OW
OX
OY
OZ
PA
PB
PC
PD
PE
PF
PG
PH
PI
PJ
PK
PL
PM
PN
PO
PP
PQ
PR
PS
PT
PU
PV
PW
PX
PY
PZ
QA
QB
QC
QD
QE
QF
QG
QH
QI
QJ
QK
QL
QM
QN
QO
QP
QQ
QR
QS
QT
QU
QV
QW
QX
QY
QZ
RA
RB
RC
RD
RE
RF
RG
RH
RI
RJ
RK
RL
RM
RN
RO
RP
RQ
RR
RS
RT
RU
RV
RW
RX
RY
RZ
SA
SB
SC
SD
SE
SF
SG
SH
SI
SJ
SK
SL
SM
SN
SO
SP
SQ
SR
SS
ST
SU
SV
SW
SX
SY
SZ
TA
TB
TC
TD
TE
TF
TG
TH
TI
TJ
TK
TL
TM
TN
TO
TP
TQ
TR
TS
TT
TU
TV
TW
TX
TY
TZ
UA
UB
UC
UD
UE
UF
UG
UH
UI
UJ
UK
UL
UM
UN
UO
UP
UQ
UR
US
UT
UU
UV
UW
UX
UY
UZ
VA
VB
VC
VD
VE
VF
VG
VH
VI
VJ
VK
VL
VM
VN
VO
VP
VQ
VR
VS
VT
VU
VV
VW
VX
VY
VZ
WA
WB
WC
WD
WE
WF
WG
WH
WI
WJ
WK
WL
WM
WN
WO
WP
WQ
WR
WS
WT
WU
WV
WW
WX
WY
WZ
XA
XB
XC
XD
XE
XF
XG
XH
XI
XJ
XK
XL
XM
XN
XO
XP
XQ
XR
XS
XT
XU
XV
XW
XX
XY
XZ
YA
YB
YC
YD
YE
YF
YG
YH
YI
YJ
YK
YL
YM
YN
YO
YP
YQ
YR
YS
YT
YU
YV
YW
YX
YY
YZ
ZA
ZB
ZC
ZD
ZE
ZF
ZG
ZH
ZI
ZJ
ZK
ZL
ZM
ZN
ZO
ZP
ZQ
ZR
ZS
ZT
ZU
ZV
ZW
ZX
ZY
ZZ

Schlauchklemmen
Tubing Clamps
Pinzas para tubos
Presses-tube
Pinze serratubi

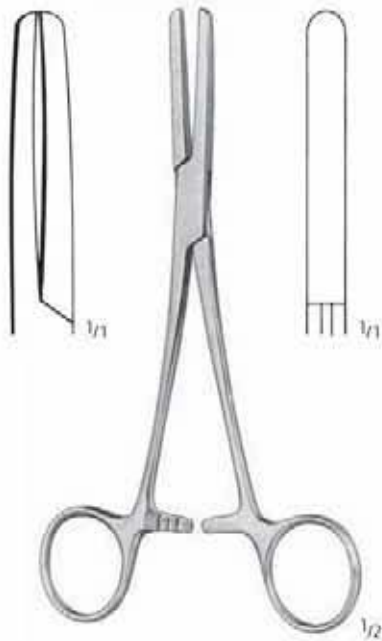

PRESBYTERIAN

16,5 cm/6 1/2" AA 790/16
18,0 cm/7" AA 790/18



KLINIKUM BERLIN

AA 792/14
14,5 cm/5 3/4"
mit langer Sperre
with long ratchet
con cremallera larga
à crémaillère extra longue
con cremagliera extra lunga



AA 794/15

AA 794/15
AA 794/18
AA 794/20

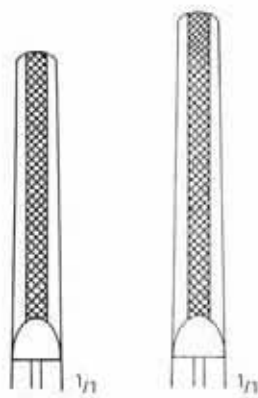

AA 794/18

AA 794/20

15,5 cm/6"
18,0 cm/7"
20,0 cm/8"

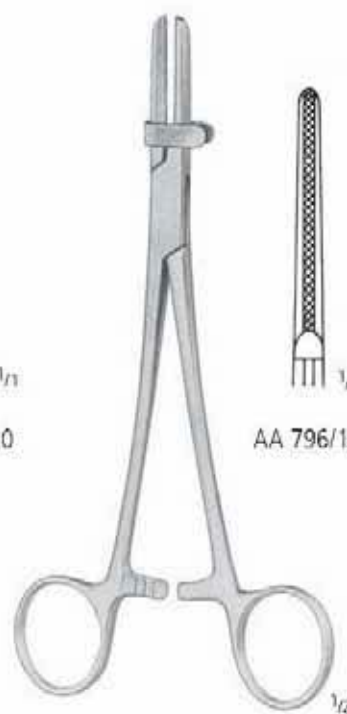

AA 796/15

AA 796/15
AA 796/18
AA 796/20

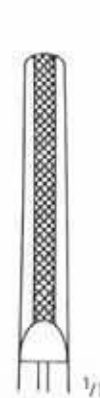

AA 796/18



AA 796/20

PINZETTEN
FORCEPS
PINZAS
PINCES
PINZE

AB

nopa[®] instruments

Weitere Pinzetten finden Sie in unserem Katalog „Allgemeines Instrumentarium“ in Gruppe AB.

For further forceps kindly refer to our catalogue "General Instruments", section AB.

Para pinzas adicionales, por favor consulte nuestro catálogo de "Instrumental de uso general", grupo AB.

Pour des pinces supplémentaires, consultez notre catalogue „Instrumentation Generale“, section AB.

Per gli altri pinze, consultare il nostro catalogo "Strumentazione Generale", gruppo AB.



AB PINZETTEN FORCEPS PINZAS PINCES PINZE

Anatomische Pinzetten, Chirurgische Pinzetten
 Dressing Forceps, Tissue Forceps
 Pinzas de disección, Pinzas de disección con dientes
 Pincers à dissection, Pincers à griffes
 Pinze anatomiche per dissezione, Pinze chirurgiche a denti di topo



STANDARD

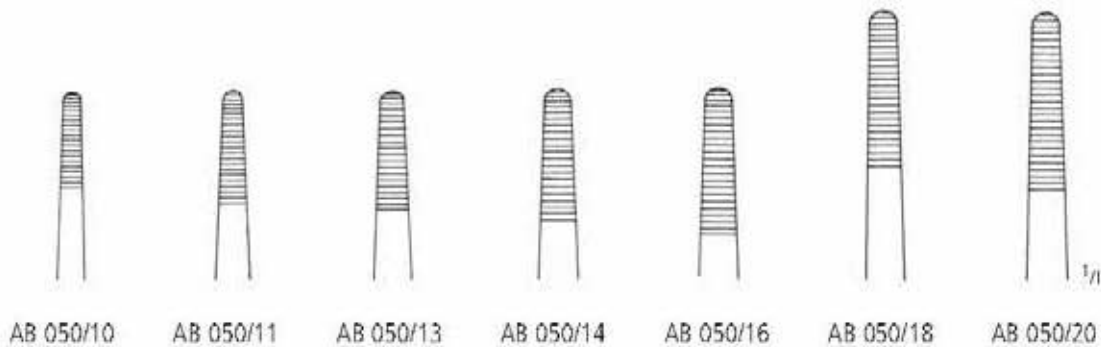

10,5 cm/4 1/4"	AB 050/10
11,5 cm/4 1/2"	AB 050/11
13,0 cm/5"	AB 050/13
14,5 cm/5 3/4"	AB 050/14
16,0 cm/6 1/4"	AB 050/16
18,0 cm/7"	AB 050/18
20,0 cm/8"	AB 050/20



**1:2
STANDARD**

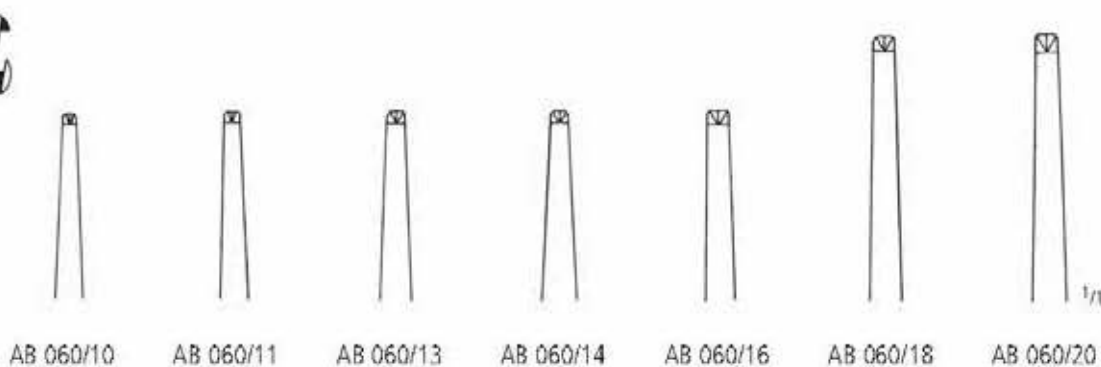

10,5 cm/4 1/4"	AB 060/10
11,5 cm/4 1/2"	AB 060/11
13,0 cm/5"	AB 060/13
14,5 cm/5 3/4"	AB 060/14
16,0 cm/6 1/4"	AB 060/16
18,0 cm/7"	AB 060/18
20,0 cm/8"	AB 060/20

PINZETTEN FORCEPS PINZAS PINCES PINZE

Anatomische Pinzetten, Chirurgische Pinzetten
 Dressing forceps, Tissue forceps
 Pinzas de disección, Pinzas de disección con dientes
 Pincers à dissection, Pincers à griffes
 Pinze anatomiche per dissezione, Pinze chirurgiche a denti di topo

AA
AB
 AC
 AD
 AE
 AF
 AG
 AH
 AI
 AJ
 AK
 AL
 AM
 AN
 AO
 AP
 AQ
 AR
 AS
 AT
 AU
 AV
 AW
 AX



AB 062/14

2:3

- 13,0 cm/5"
- 14,5 cm/5¾"
- 16,0 cm/6¼"
- 18,0 cm/7"
- 20,0 cm/8"

- AB 062/13
- AB 062/14
- AB 062/16
- AB 062/18
- AB 062/20



AB 064/14

3:4

- AB 064/13
- AB 064/14
- AB 064/16

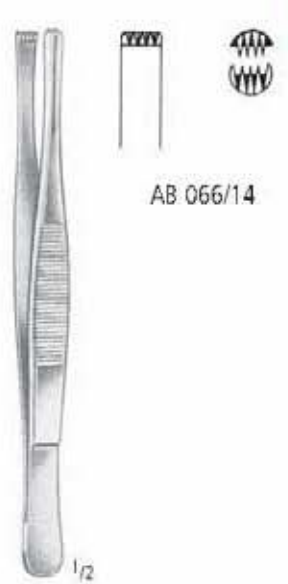

AB 066/14

4:5

- AB 066/13
- AB 066/14
- AB 066/16

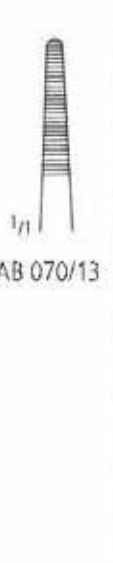

AB 070/13

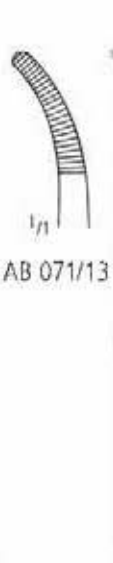

AB 071/13

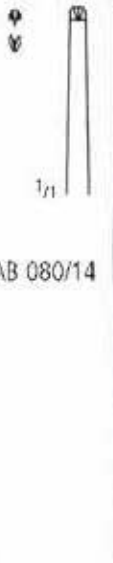

AB 080/14

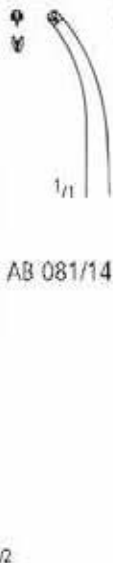

AB 081/14

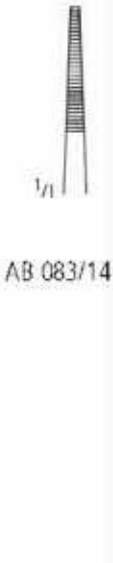

AB 083/14



AB 084/14

1:2

1:2

schmal - narrow - estrechas - étroites - strette

fein - delicate - finas - fines - fine

10,5 cm/4¼"	AB 070/10	AB 071/10	AB 080/10	AB 081/10
11,5 cm/4½"	AB 070/11	AB 071/11	AB 080/11	AB 081/11
13,0 cm/5"	AB 070/13	AB 071/13	AB 080/13	AB 081/13
14,5 cm/5¾"	AB 070/14	AB 071/14	AB 080/14	AB 081/14
16,0 cm/6¼"	AB 070/16	AB 071/16	AB 080/16	AB 081/16
18,0 cm/7"	AB 070/18	AB 071/18	AB 080/18	AB 081/18
20,0 cm/8"	AB 070/20	AB 071/20	AB 080/20	AB 081/20

AB 083/13	AB 084/13
AB 083/14	AB 084/14

AB PINZETTEN FORCEPS PINZAS PINCES PINZE

Anatomische Pinzetten, Chirurgische Pinzetten
 Dressing Forceps, Tissue Forceps
 Pinzas de disección, Pinzas de disección con dientes
 Pincès à dissection, Pincès à griffes
 Pinze anatomiche per dissezione, Pinze chirurgiche a denti di topo

MODELL USA

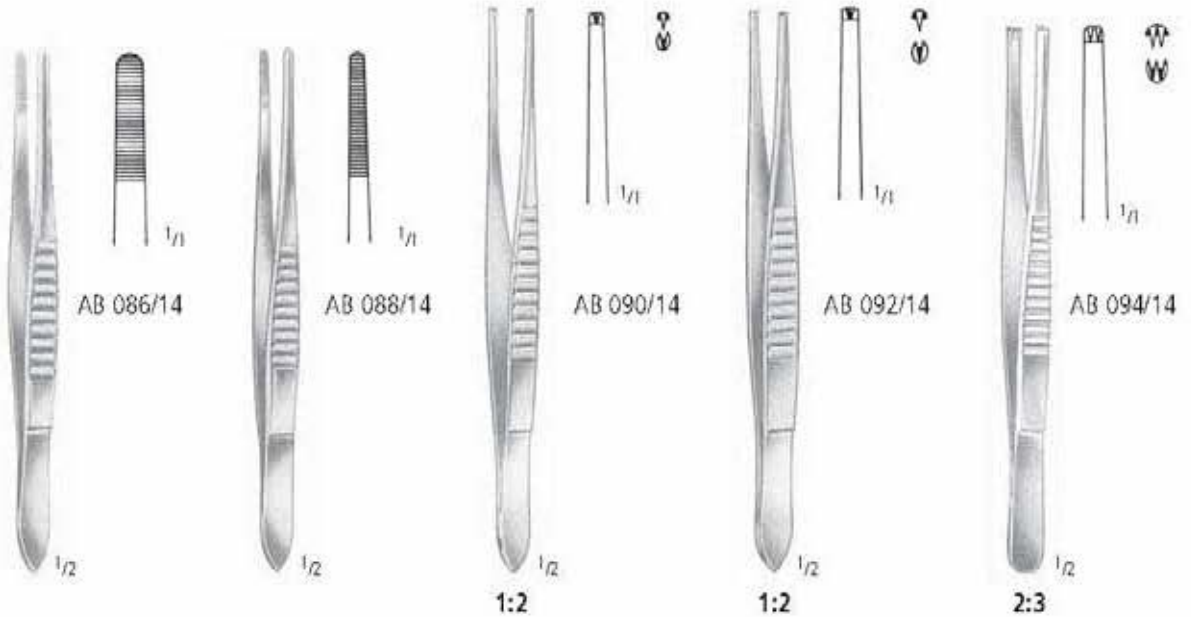

schmal - narrow - estrechas - étroites - strette

12,0 cm/4 ³ / ₄ "	AB 086/12	AB 088/12		AB 092/12	AB 094/12
13,0 cm/5"	AB 086/13	AB 088/13	AB 090/13	AB 092/13	AB 094/13
14,5 cm/5 ³ / ₄ "	AB 086/14	AB 088/14	AB 090/14	AB 092/14	AB 094/14
15,5 cm/6"	AB 086/15	AB 088/15	AB 090/15	AB 092/15	AB 094/15
18,0 cm/7"	AB 086/18			AB 092/18	AB 094/18

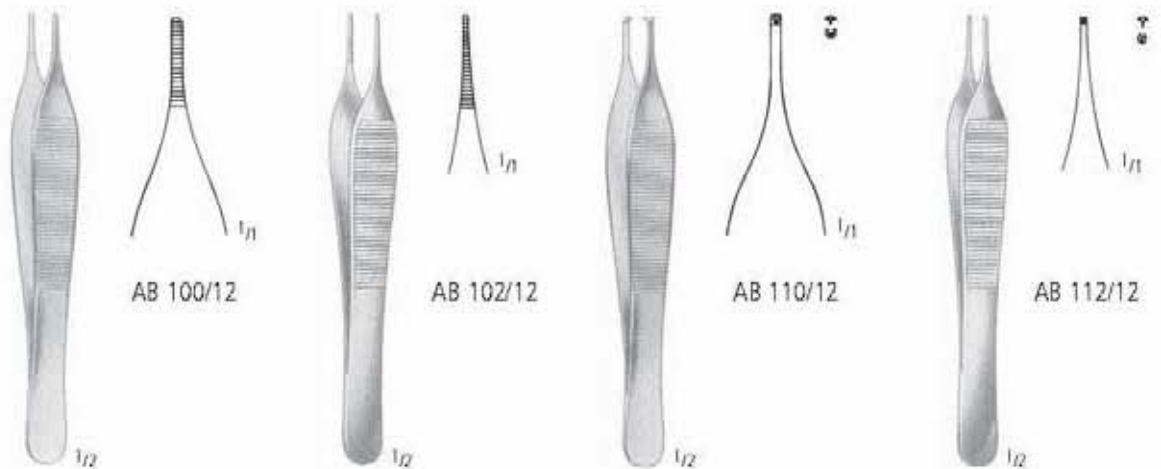

	ADSON	MICRO-ADSON	ADSON 1:2	MICRO-ADSON 1:2
12,0 cm/4 ³ / ₄ "	AB 100/12	AB 102/12	AB 110/12	AB 112/12
15,0 cm/6"	AB 100/15	AB 102/15	AB 110/15	AB 112/15

PINZETTEN FORCEPS PINZAS PINCES PINZE

Anatomische Pinzetten, Chirurgische Pinzetten
 Dressing Forceps, Tissue Forceps
 Pinzas de disección, Pinzas de disección con dientes
 Pincers à dissection, Pincers à griffes
 Pinze anatomiche per dissezione, Pinze chirurgiche a denti di topo



ADSON
 AB 114/12
 12,0 cm/4³/₄"



ADSON 1:2
 AB 115/12
 12,0 cm/4³/₄"



ADSON-BROWN
 12,0 cm/4³/₄"



ADSON-BROWN
 AB 117/09
 12,0 cm/4³/₄"

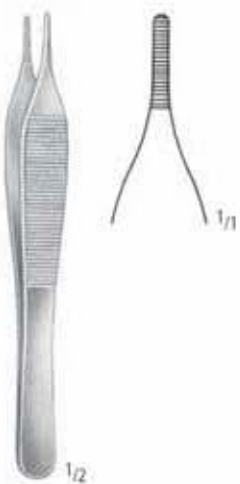

EWALD
 AB 118/01
 12,0 cm/4³/₄"



EWALD 1:2
 AB 118/02
 12,0 cm/4³/₄"



McINDOE
 AB 119/15
 15,0 cm/6"



SEMKEN
 AB 120/12
 AB 120/15

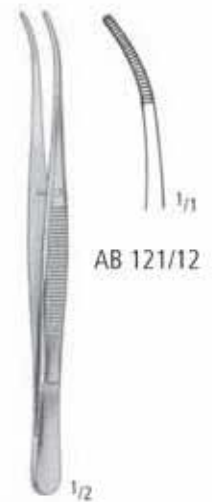

SEMKEN
 12,5 cm/5"
 15,5 cm/6"
 AB 121/12
 AB 121/15

AA
 AB
 AC
 AD
 AE
 AF
 AK
 AL
 AO
 AP
 AR
 KA
 KL
 KM
 KO
 KU
 KYE
 X

AB PINZETTEN FORCEPS PINZAS PINCES PINZE

Anatomische Pinzetten, Chirurgische Pinzetten
 Dressing Forceps, Tissue Forceps
 Pinzas de disección, Pinzas de disección con dientes
 Pincès à dissection, Pincès à griffes
 Pinze anatomiche per dissezione, Pinze chirurgiche a denti di topo

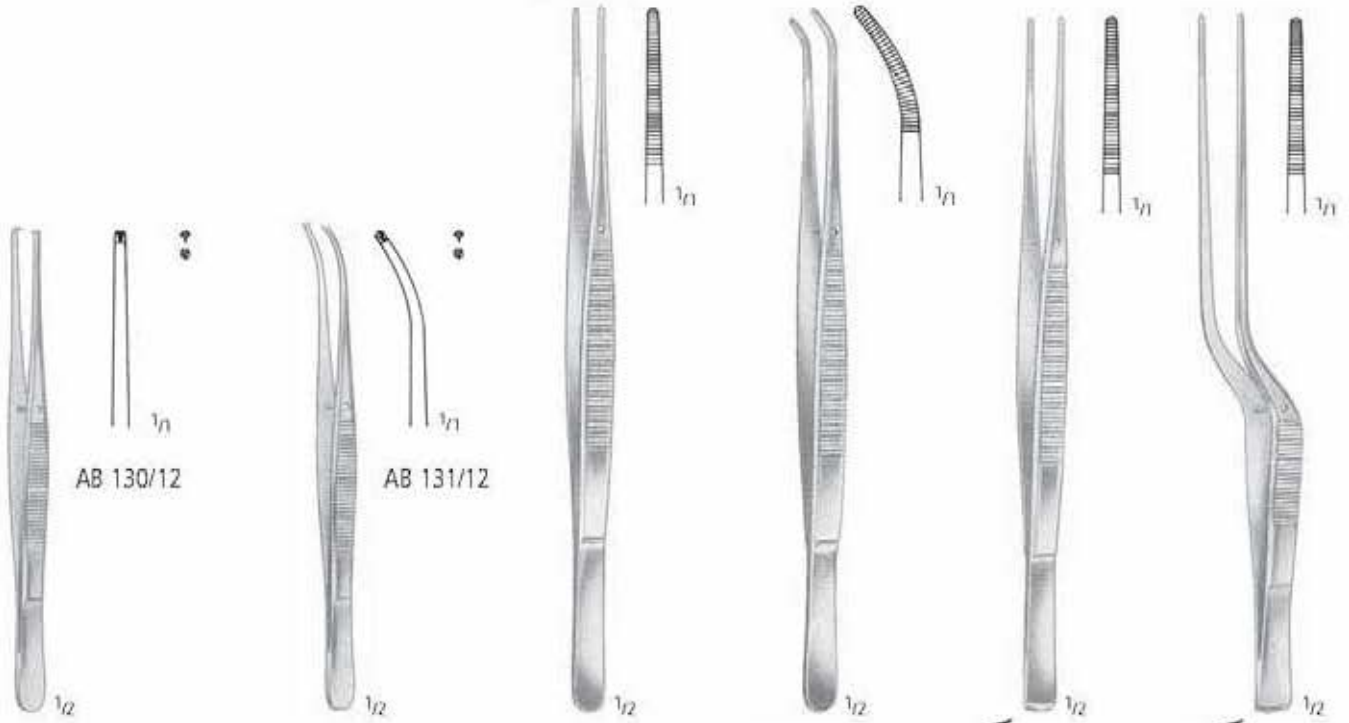

SEMKEN 1:2			TAYLOR	TAYLOR	TAYLOR	TAYLOR
AB 130/12	12,5 cm/5"	AB 131/12	AB 140/17	AB 141/17	AB 142/17	AB 143/17
AB 130/15	15,5 cm/6"	AB 131/15	17,5 cm/7"	17,5 cm/7"	17,5 cm/7"	17,5 cm/7"

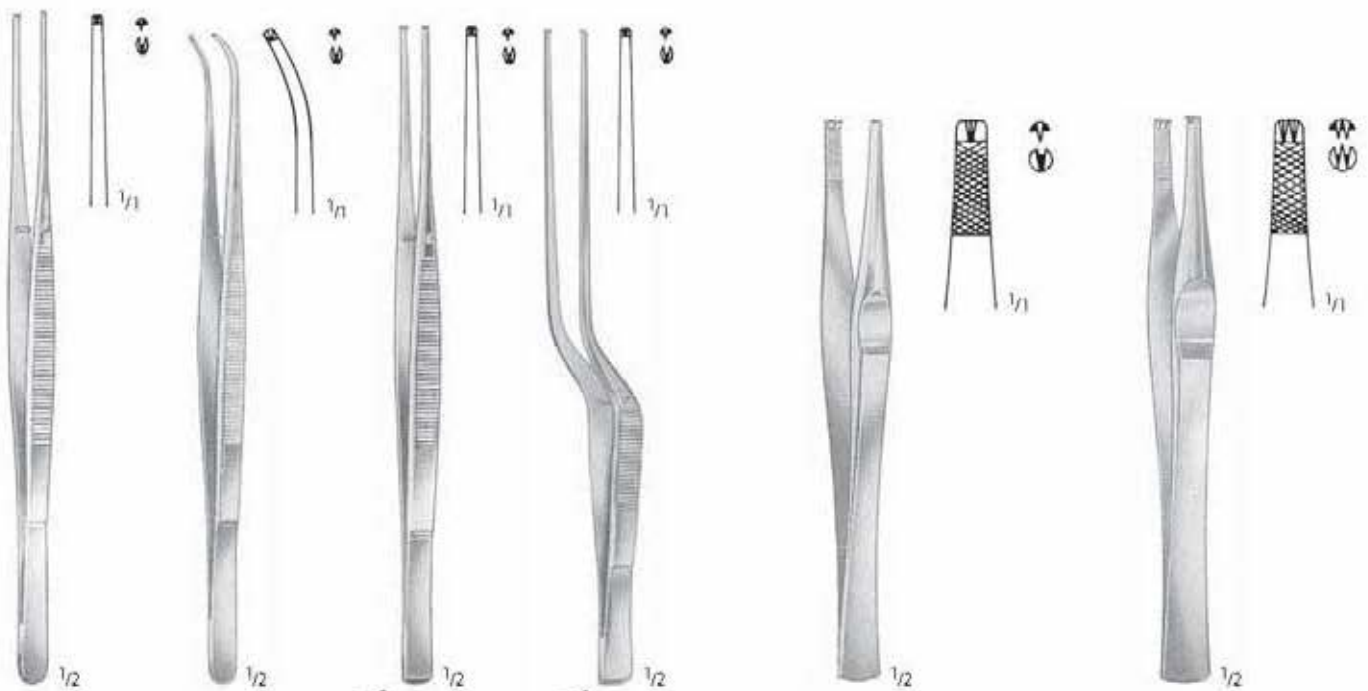

TAYLOR	TAYLOR	TAYLOR	TAYLOR	LANE	LANE
1:2	1:2	1:2	1:2	1:2	2:3
AB 150/17	AB 151/17	AB 152/17	AB 153/17	AB 156/14	AB 158/14
17,5 cm/7"	17,5 cm/7"	17,5 cm/7"	17,5 cm/7"	14,5 cm/5 ³ / ₄ "	20,0 cm/8"
				AB 156/20	AB 158/20

PINZETTEN FORCEPS PINZAS PINCES PINZE

Anatomische Pinzetten, Chirurgische Pinzetten
 Dressing Forceps, Tissue Forceps
 Pinzas de disección, Pinzas de disección con dientes
 Pincers à dissection, Pincers à griffes
 Pinze anatomiche per dissezione, Pinze chirurgiche a denti di topo



GERALD
 AB 160/18 18,0 cm/7"



GERALD
 AB 161/18



GERALD 1:2
 AB 170/18 18,0 cm/7"



GERALD 1:2
 AB 171/18



CUSHING
 AB 180/17 17,5 cm/7"



CUSHING
 AB 181/17



CUSHING 1:2
 AB 190/17 17,5 cm/7"



CUSHING 1:2
 AB 191/17

AA
AB
 AC
 AD
 AE
 AF
 AK
 AL
 AO
 AP
 AR
 KA
 KL
 KM
 KO
 KU
 KYE
 X

AB PINZETTEN FORCEPS PINZAS PINCES PINZE

Anatomische Pinzetten, Chirurgische Pinzetten
 Dressing Forceps, Tissue Forceps
 Pinzas de disección, Pinzas de disección con dientes
 Pincés à dissection, Pincés à griffes
 Pinze anatomiche per dissezione, Pinze chirurgiche a denti di topo

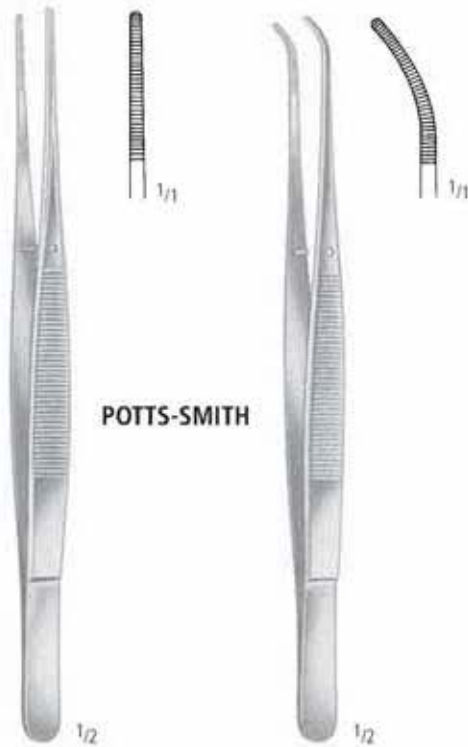

POTTS-SMITH

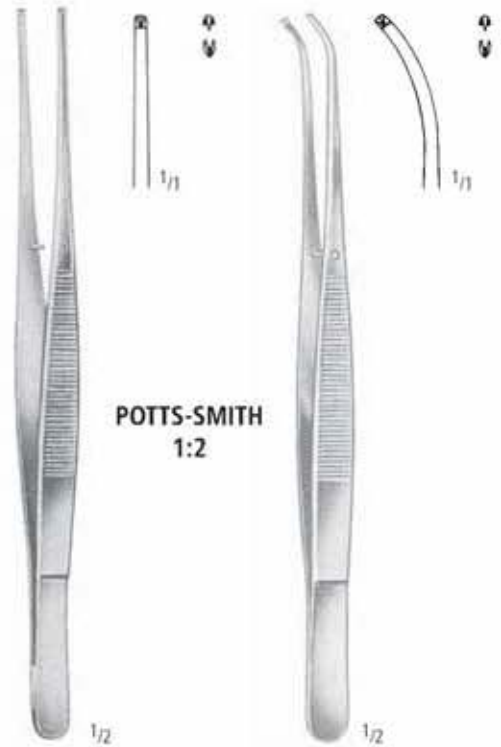

**POTTS-SMITH
1:2**

18,0 cm/7"

AB 200/18

AB 201/18

AB 210/18

AB 211/18

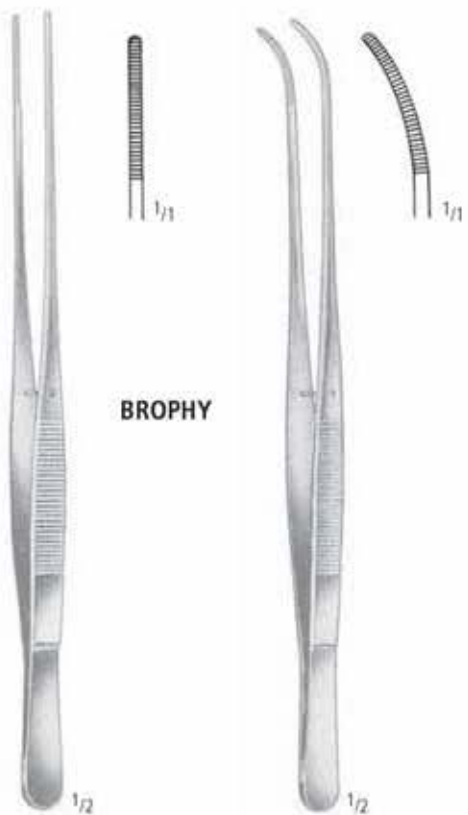

BROPHY



**BROPHY
1:2**

20,0 cm/8"

AB 250/20

AB 251/20

AB 260/20

AB 261/20

PINZETTEN FORCEPS PINZAS PINCES PINZE

Anatomische Pinzetten, Chirurgische Pinzetten
 Dressing forceps, Tissue forceps
 Pinzas de disección, Pinzas de disección con dientes
 Pincés à dissection, Pincés à griffes
 Pinze anatomiche per dissezione, Pinze chirurgiche a denti di topo

AA

AB

AC

AD

AE

AF

AK

AL

AO

AP

AR

KA

KL

KM

KO

KU

KYE

X



BROWN
 AB 270/15
 AB 270/20
 15,0 cm/6"
 20,0 cm/8"



DUEHRSSSEN
 AB 290/20



DUEHRSSSEN 1:2
 AB 292/20



DUEHRSSSEN 2:3
 AB 294/20

AB PINZETTEN FORCEPS PINZAS PINCES PINZE

Anatomische Pinzetten, Chirurgische Pinzetten
 Dressing Forceps, Tissue Forceps
 Pinzas de disección, Pinzas de disección con dientes
 Pincers à dissection, Pincers à griffes
 Pinze anatomiche per dissezione, Pinze chirurgiche a denti di topo



AB 316/20



FERRIS-SMITH 2:3

AB 320/18
 18,0 cm/7"

STILLE-BARRAYA 3:4

18,0 cm/7" AB 316/18
 20,0 cm/8" AB 316/20



11,0 cm/4 1/2"
 13,0 cm/5"
 15,0 cm/6"

STILLE
 AB 370/11
 AB 370/13
 AB 370/15



STILLE 1:2
 AB 380/15
 15,0 cm/6"



STILLE 2:3
 AB 382/15
 15,0 cm/6"

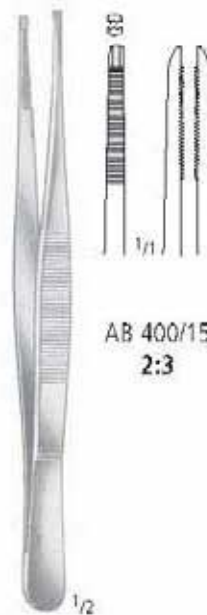

AB 400/15
 2:3

15,0 cm/6" AB 400/15
 20,0 cm/8" AB 400/20

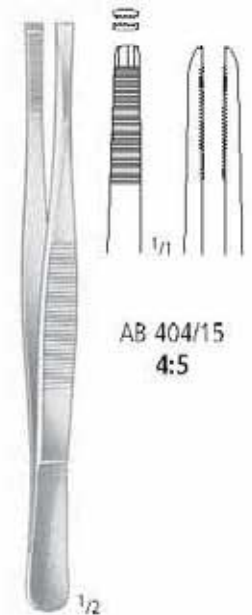

AB 404/15
 4:5

AB 404/15
 AB 404/20

ADLERKREUTZ

PINZETTEN FORCEPS PINZAS PINCES PINZE

Chirurgische Pinzetten, Fasspinzetten
 Tissue forceps, Grasping forceps
 Pinzas de disección con dientes, Pinzas para coger
 Pincers à griffes, Pincers pour saisir les tissus
 Pinze chirurgiche a denti di topo, Pinze per afferrare tessuti

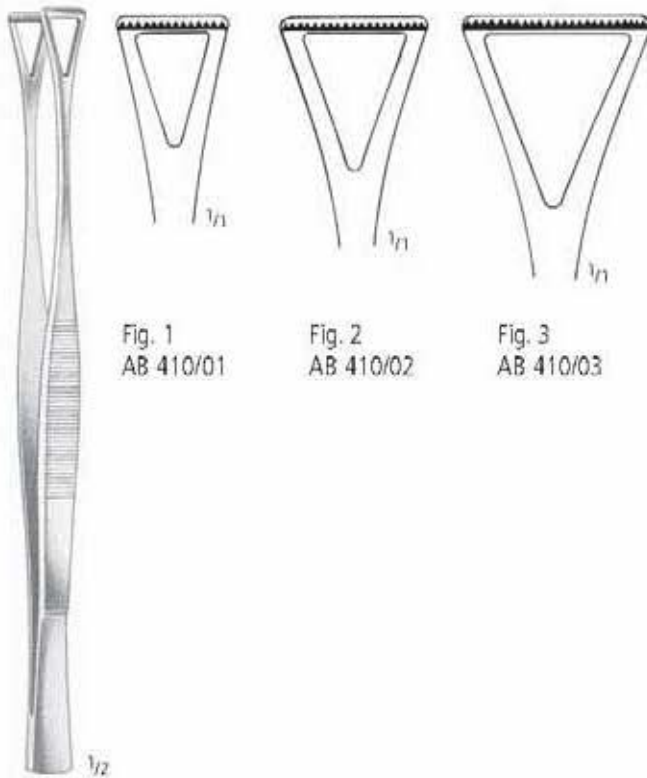
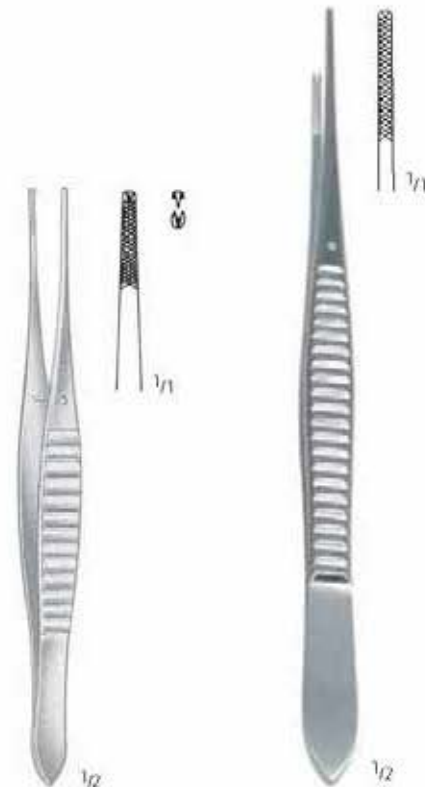

Fig. 1
AB 410/01

Fig. 2
AB 410/02

Fig. 3
AB 410/03

COLLIN-DUVAL
20,0 cm/8"



GILLIES 1:2
AB 430/15
15,0 cm/6"

WAUGH 1:2
AB 434/20
20,5 cm/8"

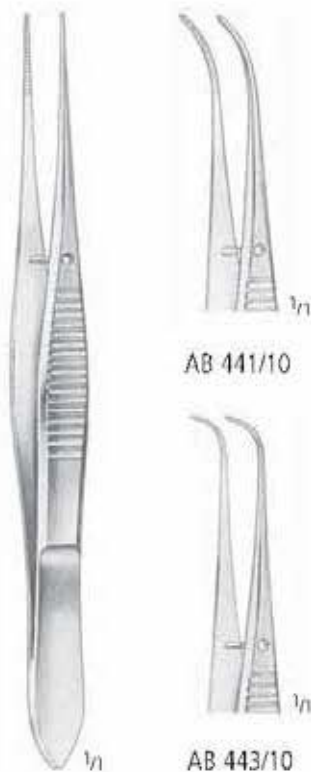

AB 440/10
10,5 cm/4 1/4"

AB 441/10

AB 443/10

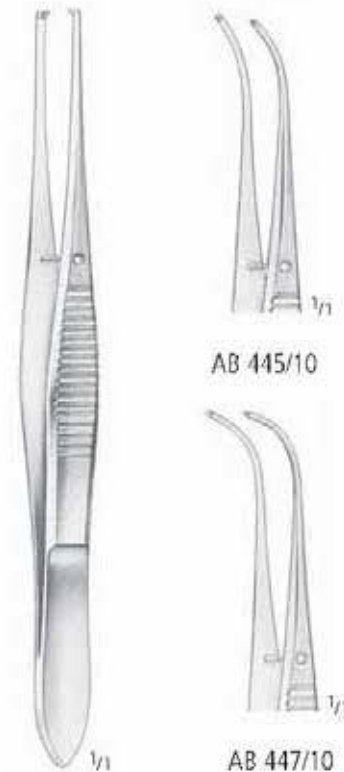

1:2
AB 444/10
10,5 cm/4 1/4"

AB 445/10

AB 447/10

AA
AB
AC
AD
AE
AF
AK
AL
AO
AP
AR
KA
KL
KM
KO
KU
KYE
X

AB PINZETTEN FORCEPS PINZAS PINCES PINZE

Chirurgische Pinzetten, Fasspinzetten
 Tissue Forceps, Grasping Forceps
 Pinzas de disección con dientes, Pinzas para coger
 Pincès à griffes, Pincès pour saisir les tissus
 Pinze chirurgiche a denti di topo, Pinze per afferrare tessuti



AB 480/15



AB 484/16

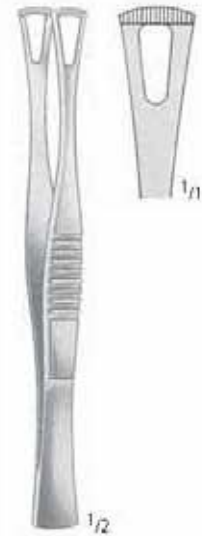

RUSS. MODELL
 15,0 cm/6"
 20,0 cm/8"

AB 480/15
 AB 480/20

DURANTE
 14,5 cm/5³/₄"
 16,0 cm/6¹/₄"
 20,0 cm/8"

AB 484/14
 AB 484/16
 AB 484/20

DUVAL
 AB 486/14
 14,5 cm/5³/₄"





BONNEY 1:2
 AB 490/18
 18,0 cm/7"



BONNEY 2:3
 AB 492/18
 18,0 cm/7"

PINZETTEN FORCEPS PINZAS PINCES PINZE

Uhrmacherpinzetten
 Jeweler's Forceps
 Pinzas de relojero
 Pincès d'horloger
 Pinze da orologiaio

	1/1	No. 1	AB 501/01 12,0 cm/4 ³ / ₄ "	AA
	1/1	No. 2	AB 501/02 12,0 cm/4 ³ / ₄ "	AB
	1/1	No. 3	AB 501/03 12,0 cm/4 ³ / ₄ "	AC
	1/1	No. 4	AB 501/04 11,0 cm/4 ¹ / ₂ "	AD
	1/1	No. 5	AB 501/05 11,0 cm/4 ¹ / ₂ "	AE
	1/1	No. 5a	AB 501/15 11,0 cm/4 ¹ / ₂ "	AF
	1/1	No. 5/45°	AB 501/45 10,5 cm/4 ¹ / ₄ "	AK
	1/1	No. 5/90°	AB 501/90 10,5 cm/4 ¹ / ₄ "	AL
	1/1	No. 7	AB 502/07 11,5 cm/4 ¹ / ₂ "	AO

X

AB PINZETTEN FORCEPS PINZAS PINCES PINZE

Mikro-Pinzetten, Knüpfpinzetten mit Plateau
 Micro Forceps, Suture Tying Forceps with platform
 Micro-Pinzas, Pinzas de ligadura con plataforma
 Micro-Pinces, Pinces à ligature avec plate-forme
 Micro-Pinze, Pinze per ligature con piattaforma

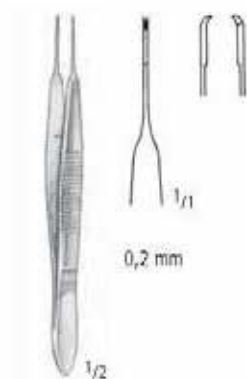

1:2
 AB 530/09
 9,5 cm/3³/₄"

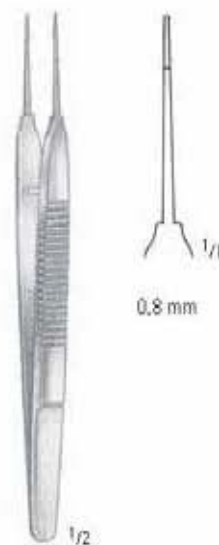

AUSTIN
 AB 532/14
 14,0 cm/5¹/₂"

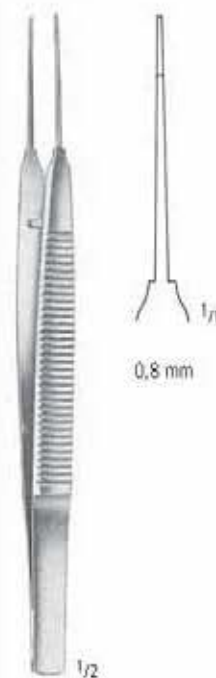

AUSTIN
 AB 532/18
 18,0 cm/7"



AB 534/12
 12,0 cm/4³/₄"



VISE
 AB 534/13
 13,5 cm/5¹/₄"



VISE
 AB 535/13
 13,5 cm/5¹/₄"

PINZETTEN FORCEPS PINZAS PINCES PINZE

Mikro-Pinzetten, Knüpfpinzetten mit Plateau, Gefäßdilator
 Micro Forceps, Suture Tying Forceps with platform, Vessel Dilator
 Micro-Pinzas, Pinzas de ligadura con plataforma, Dilatador para vasos
 Micro-Pinces, Pinces à ligature avec plate-forme, Dilatateur pour vaisseaux
 Micro-Pinze, Pinze per ligature con piattaforma, Dilatatore per vasi



AB 536/14
 14,0 cm/5 1/2"



AB 538/14 1:2
 14,0 cm/5 1/2"



AB 540/14 1:2
 14,0 cm/5 1/2"

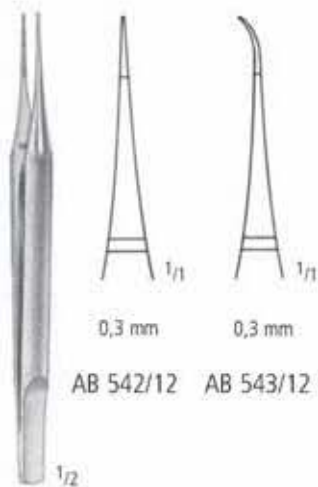

12,0 cm/4 3/4" AB 542/12 AB 543/12
 15,0 cm/6" AB 542/15 AB 543/15

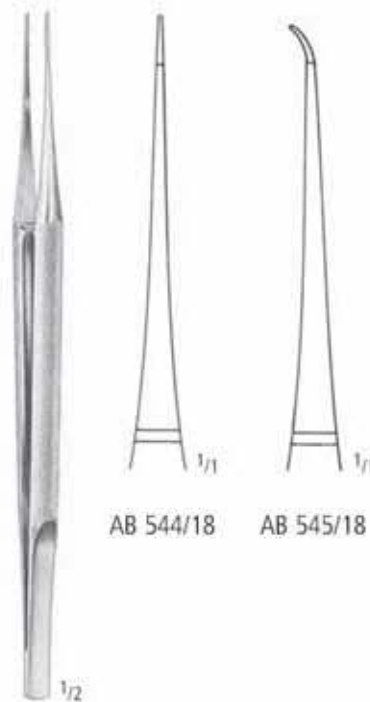

18,0 cm/7"



AB 546/11
 11,0 cm/4 1/3"

AA
AB
 AC
 AD
 AE
 AF
 AK
 AL
 AO
 AP
 AR
 KA
 KL
 KM
 KO
 KU
 KYE
 X

Splitter-Pinzetten
 Splinter Forceps
 Pinzas para espinas
 Pincès à échardes
 Pinze per schegge



AB 550/11

FEILCHENFELD

- 7,5 cm/3" AB 550/07
- 9,0 cm/3 1/2" AB 550/09
- 11,5 cm/4 1/2" AB 550/11



HUNTER

- AB 552/10
- 10,5 cm/4 1/4"



HUNTER

- AB 553/10
- 10,5 cm/4 1/4"

PINZETTEN FORCEPS PINZAS PINCES PINZE

Splitter-Pinzetten
 Splinter Forceps
 Pinzas para espinas
 Pincas à échardes
 Pinze per schegge

ohne Führungsstift
 without guide pin
 sin espiga de guía
 sans repères
 senza perno da guida

- 8,0 cm/3"
- 9,0 cm/3 1/2"
- 10,5 cm/4 1/4"
- 11,5 cm/4 1/3"
- 12,5 cm/5"
- 14,5 cm/5 3/4"



AB 562/10

- AB 562/08
- AB 562/09
- AB 562/10
- AB 562/11
- AB 562/12
- AB 562/14



AB 563/10

- AB 563/08
- AB 563/09
- AB 563/10
- AB 563/11
- AB 563/12
- AB 563/14

mit Führungsstift
 with guide pin
 con espiga de guía
 avec repères
 con perno da guida

- 10,5 cm/4 1/4"
- 11,5 cm/4 1/2"
- 12,5 cm/5"
- 14,5 cm/5 3/4"



AB 566/10

- AB 566/10
- AB 566/11
- AB 566/12
- AB 566/14



AB 567/10

- AB 567/10
- AB 567/11
- AB 567/12
- AB 567/14

AA
AB
 AC
 AD
 AE
 AF
 AK
 AL
 AO
 AP
 AR
 KA
 KL
 KM
 KO
 KU
 KYE
 X

AB PINZETTEN FORCEPS PINZAS PINCES PINZE

Splitter-Pinzetten
 Splinter Forceps
 Pinzas para espinas
 Pincers à échardes
 Pinze per schegge

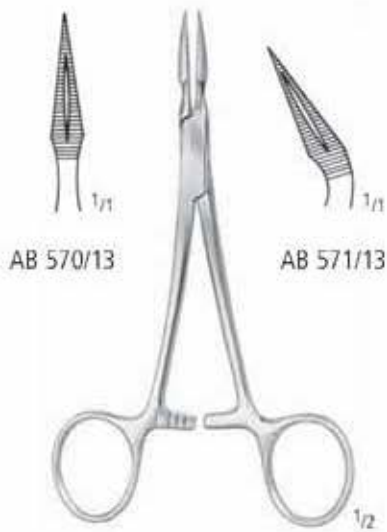

AB 570/13

AB 571/13

STIEGLITZ
 13,5 cm/5¹/₄"



STIEGLITZ
 AB 571/90
 13,5 cm/5¹/₄"

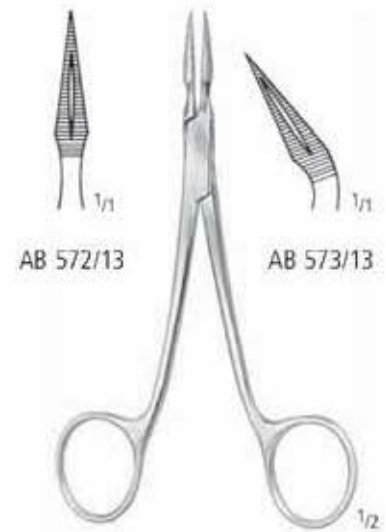

AB 572/13

AB 573/13

STIEGLITZ
 13,5 cm/5¹/₄"



PEET
 AB 580/11
 11,5 cm/4¹/₂"

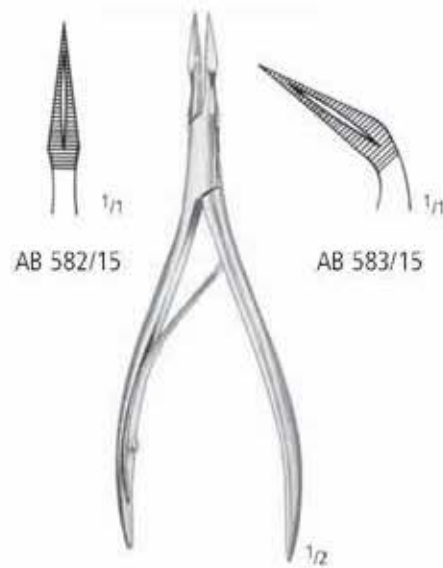

AB 582/15

AB 583/15

RALK
 15,0 cm/6"

PINZETTEN FORCEPS PINZAS PINCES PINZE

Cilienpinzetten
Cilia Forceps
Pinzas depilatorias
Pincès à épiler les cils
Pinze depilatorie



LITTAUER
AB 620/08
8,5 cm/3 1/8"



AB 621/09
9,0 cm/3 1/2"



DOUGLAS
AB 624/09
9,0 cm/3 1/2"



BEER
AB 626/09
9,0 cm/3 1/2"



ZIEGLER
AB 628/09
9,0 cm/3 1/2"

AA
AB
AC
AD
AE
AF
AG
AH
AI
AJ
AK
AL
AM
AN
AO
AP
AQ
AR
AS
AT
AU
AV
AW
AX

AB PINZETTEN FORCEPS PINZAS PINCES PINZE

Ohr- und Nasenpinzetten
 Ear and Nose Dressing Forceps
 Pinzas auriculares y nasales
 Pincès auriculaires et nasales
 Pinze auricolare e nasale



AB 650/11



AB 652/12



TROELTSCH (WILDE)

Mod. Jalasvirta

AB 654/11

AB 654/13

11,0 cm/4¹/₃"

13,0 cm/5"

11,0 cm/4¹/₃"

AB 650/11

12,0 cm/4³/₄"

AB 650/12

15,0 cm/6"

AB 650/15

18,0 cm/7"

AB 650/18

TROELTSCH (WILDE) 1:2

AB 652/12

AB 652/15

AB 652/18



LUCAE

AB 656/14

14,0 cm/5¹/₂"



LUCAE 1:2

AB 658/14

14,0 cm/5¹/₂"



AB 660/18

JANSEN

16,0 cm/6¹/₄"

AB 660/16

18,0 cm/7"

AB 660/18

20,0 cm/8"

AB 660/20



COTTLE

AB 665/14

14,0 cm/5¹/₂"

PINZETTEN FORCEPS PINZAS PINCES PINZE

Fixierpinzetten, Nahtpinzetten
 Fixation Forceps, Suture Forceps
 Pinzas de fijación, Pinzas para sutura
 Pincès à fixer, Pincès pour sutures
 Pinze fissatrice, Pinze per sutura



ELSCHNIG 3:4
 AB 794/11
 11,0 cm/4¹/₃"



ST. MARTIN 1:2
 AB 812/07
 7,0 cm/2³/₄"



0,12 mm
 0,30 mm
 0,50 mm
 1,00 mm
 1,50 mm

AB 816/01
 AB 816/03
 AB 816/05
 AB 816/10
 AB 816/15

CASTROVIEJO 1:2
 10,0 cm/4"



AB 817/01

AB 817/01
 AB 817/03
 AB 817/05
 AB 817/10
 AB 817/15

CASTROVIEJO 1:2
 10,0 cm/4"



AB 819/01



McPHERSON
 10,0 cm/4"



AB 819/02



10 x
 0,3 mm

KELMAN-McPHERSON 1:2
 AB 820/10
 10,0 cm/4"

AA
 AB
 AC
 AD
 AE
 AF
 AG
 AH
 AI
 AJ
 AK
 AL
 AM
 AN
 AO
 AP
 AQ
 AR
 AS
 AT
 AU
 AV
 AW
 AX

AB PINZETTEN FORCEPS PINZAS PINCES PINZE

Nahtpinzetten
Suture Forceps
Pinzas para sutura
Pincas pour sutures
Pinze per sutura



BONACCOLTO
AB 824/01
10,0 cm/4"



BONACCOLTO
AB 824/02
10,0 cm/4"



10 x
0,12 mm AB 825/01



AB 825/02

MOD. BONN
10,0 cm/4"



MOD. TÜBINGEN
AB 826/10
10,0 cm/4"



PAUFIQUE 1:2
AB 828/10
10,0 cm/4"



HARMS
AB 829/01
10,0 cm/4"



HARMS
AB 829/02
10,0 cm/4"

PINZETTEN FORCEPS PINZAS PINCES PINZE

Atraumatische Pinzetten
 Non-traumatic Vascular Tissue Forceps
 Pinzas Atrauma
 Pincas Atrauma
 Pinze Atrauma



AB 860/16 = 16,0 cm/6¹/₄"
 AB 860/20 = 20,0 cm/8"

DE BAKAY



AB 862/16 = 16,0 cm/6¹/₄"
 AB 862/20 = 20,0 cm/8"

DE BAKAY

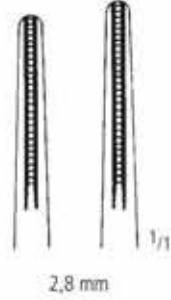

AB 864/16 = 16,0 cm/6¹/₄"
 AB 864/20 = 20,0 cm/8"

DE BAKAY



AB 866/20 = 20,0 cm/8"

DE BAKAY



AB 869/16 = 16,0 cm/6¹/₄"
 AB 869/20 = 20,0 cm/8"

DE BAKAY

AA
 AB
 AC
 AD
 AE
 AF
 AK
 AL
 AO
 AP
 AR
 KA
 KL
 KM
 KO
 KU
 KYE
 X

AB PINZETTEN FORCEPS PINZAS PINCES PINZE

Pinzetten mit Hartmetalleinsätzen
 Dissecting Forceps with Tungsten Carbide Inserts
 Pinzas de disección con bocas de carburo de tungsteno
 Pinces à dissection avec mors en carbure de tungstène
 Pinze per dissezione con punte di carburo di tungsteno

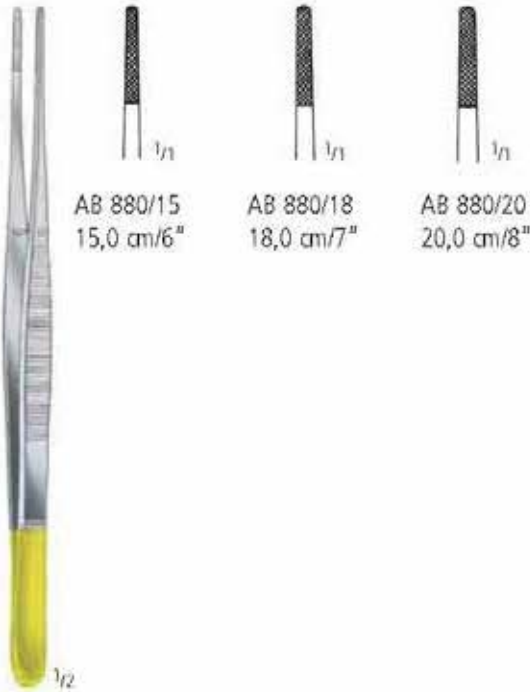

AB 880/15 15,0 cm/6"
 AB 880/18 18,0 cm/7"
 AB 880/20 20,0 cm/8"

POTTS-SMITH

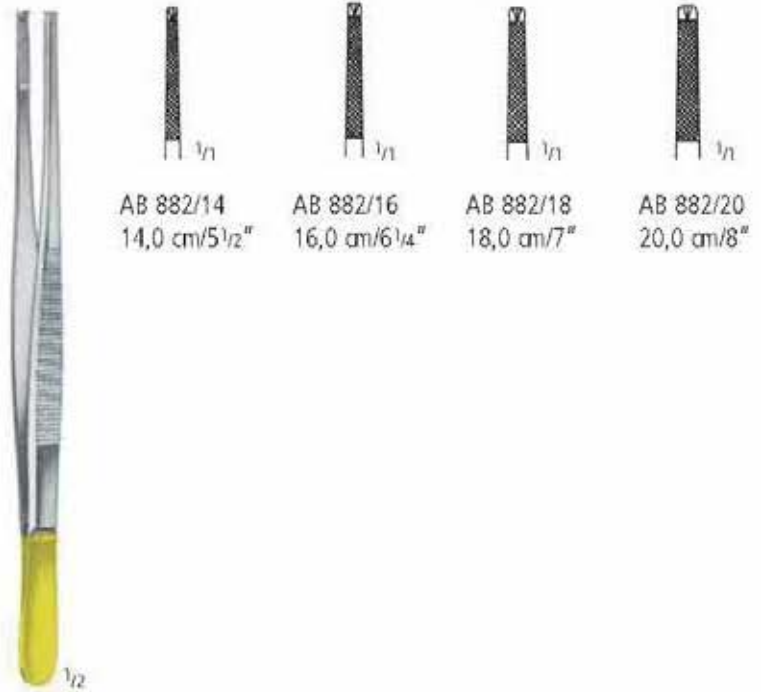

AB 882/14 14,0 cm/5 1/2"
 AB 882/16 16,0 cm/6 1/4"
 AB 882/18 18,0 cm/7"
 AB 882/20 20,0 cm/8"

OEHLER 1:2



AB 890/12

SEMKEN
 AB 890/12 12,5 cm/5"
 AB 890/15 15,5 cm/6"



GILLIES 1:2
 AB 900/15 15,0 cm/6"



JEWELER
 AB 902/15 15,0 cm/6"

PINZETTEN FORCEPS PINZAS PINCES PINZE

Pinzetten mit Hartmetalleinsätzen
 Dissecting forceps with Tungsten Carbide Inserts
 Pinzas de disección con bocas de carburo de tungsteno
 Pincers à dissection avec mors en carbure de tungstène
 Pinze per dissezione con punte di carburo di tungsteno



AA

AB

AC

AD

AE

AF

AK

AL

AO

AP

AR

KA

KL

KM

KO

KU

KYE

X

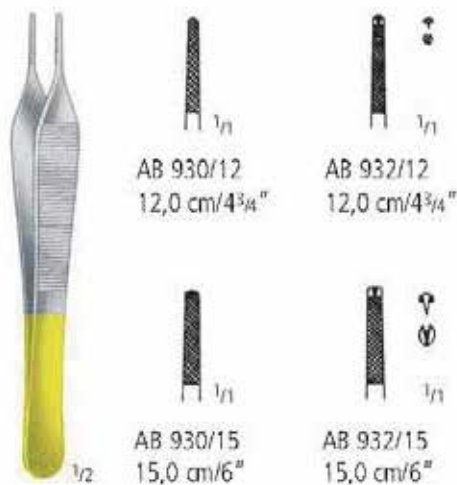

ADSON



CUSHING
17,5 cm/7"

CUSHING-TAYLOR
AB 943/18
18,0 cm/7"

AB PINZETTEN FORCEPS PINZAS PINCES PINZE

Pinzetten mit Hartmetalleinsätzen
 Dissecting Forceps with Tungsten Carbide Inserts
 Pinzas de disección con bocas de carburo de tungsteno
 Pincès à dissection avec mors en carbure de tungstène
 Pinze per dissezione con punte di carburo di tungsteno



DE BAKEY
 16,0 cm/6¹/₄"
 20,0 cm/8"

1,5 mm	2,0 mm
AB 944/16	AB 946/16
AB 944/20	AB 946/20



BONNEY 1:2
 AB 948/18
 18,0 cm/7"



WANGENSTEEN
 AB 950/15
 15,0 cm/6"

SCHEREN
SCISSORS
TIJERAS
CISEAUX
FORBICI

AC

nopa[®] instruments

Weitere Scheren finden Sie in unserem Katalog „Allgemeines Instrumentarium“ in Gruppe AC.

For further scissors kindly refer to our catalogue "General Instruments", section AC.

Para tijeras adicionales, por favor consulte nuestro catálogo de "Instrumental de uso general", grupo AC.

Pour des ciseaux supplémentaires, consultez notre catalogue „Instrumentation Generale“, section AC.

Per gli altri forbici, consultare il nostro catalogo "Strumentazione Generale", gruppo AC.



nopa[®] SC
SUPER CUT



Besonderheit:

nopa Super Cut Scheren haben eine rasierklingenscharfe Schneide, kombiniert mit einer mikrogezahnten Schneide.

>> Diese Scheren sind durch schwarze Ringe gekennzeichnet.

Features:

nopa Super Cut scissors have a razor-like edge combined with one micro serrated blade.

>> Black rings for easy identification.

Verfügbare Modelle / Available Patterns

Im Katalog durch * markiert. / Marked in the catalog with *

- AC 020/13 SC STANDARD OPER.SCS.STR.SH/BL 13,0 CM SC
- AC 020/14 SC STANDARD OPER.SCS.STR.SH/BL 14,0 CM SC
- AC 021/13 SC STANDARD OPER.SCS.CVD.SH/BL 13,0 CM SC
- AC 021/14 SC STANDARD OPER.SCS.CVD.SH/BL 14,0 CM SC
- AC 070/14 SC MAYO OPER.SCS.STR.BL/BL 14,5 CM SC
- AC 070/17 SC MAYO OPER.SCS.STR.BL/BL 17,0 CM SC
- AC 071/14 SC MAYO OPER.SCS.CVD.BL/BL 14,5 CM SC
- AC 071/17 SC MAYO OPER.SCS.CVD.BL/BL 17,0 CM SC
- AC 072/17 SC MAYO-STILLE OPER.SCS.STR.BL/BL 17,0 CM SC
- AC 073/17 SC MAYO-STILLE OPER.SCS.CVD.BL/BL 17,0 CM SC
- AC 100/14 SC METZENBAUM SCISSORS STR.BL/BL 14,0 CM SC
- AC 101/14 SC METZENBAUM SCISSORS CVD.BL/BL 14,0 CM SC
- AC 110/18 SC METZENBAUM-NELSON SCS.BL/BL 18,0 CM SC
- AC 110/20 SC METZENBAUM-NELSON SCS.STR.BL/BL 20,0 CM SC
- AC 111/18 SC METZENBAUM-NELSON SCS.CVD.BL/BL 18,0 CM SC
- AC 111/20 SC METZENBAUM-NELSON SCS.CVD.BL/BL 20,0 CM SC
- AC 140/14 SC METZENBAUM-DELICATE BL/BL STR. 14,5 CM SC
- AC 141/14 SC METZENBAUM-DELICATE BL/BL CVD. 14,5 CM SC
- AC 142/14 SC METZENBAUM-DELICATE SH/SH STR. 14,5 CM SC
- AC 143/14 SC METZENBAUM-DELICATE SH/SH CVD. 14,5 CM SC
- AC 150/18 SC METZENBAUM-DELICATE BL/BL STR. 18,0 CM SC
- AC 150/20 SC METZENBAUM-DELICATE BL/BL STR. 20,0 CM SC
- AC 151/18 SC METZENBAUM-DELICATE BL/BL CVD. 18,0 CM SC
- AC 151/20 SC METZENBAUM DELICATE BL/BL CVD. 20,0 CM SC
- AC 152/18 SC METZENBAUM-DELICATE SH/SH STR. 18,0 CM SC
- AC 152/20 SC METZENBAUM-DELICATE SH/SH STR. 20,0 CM SC
- AC 153/18 SC METZENBAUM-DELICATE SH/SH CVD. 18,0 CM SC
- AC 153/20 SC METZENBAUM-DELICATE SH/SH CVD. 20,0 CM SC
- AC 214/15 SC REYNOLDS DISS.SCISSORS STR. SH/SH 15,0 CM SC
- AC 214/18 SC REYNOLDS DISS.SCISSORS STR. SH/SH 18,0 CM SC
- AC 215/15 SC REYNOLDS DISS.SCISSORS CVD. SH/SH 15,0 CM SC
- AC 215/18 SC REYNOLDS DISS.SCS. CVD. SH/SH 18,0 CM SC
- AC 476/11 SC STEVENS TENOTOM.SCS.STR. BL/BL 11,5 CM SC

AA
AB
AC
AD
AE
AF
AK
AL
AO
AP
AR
KA
KL
KM
KO
KU
KYE
X

Chirurgische Scheren
Operating Scissors
Tijeras para cirugía
Ciseaux à chirurgie
Forbici per chirurgia



STANDARD

Fig.1
gerade
straight
rectas
droits
rette

- | | |
|-----------|---|
| AC 010/10 | 10,5 cm/4 ¹ / ₄ " |
| AC 010/11 | 11,5 cm/4 ¹ / ₂ " |
| AC 010/13 | 13,0 cm/5" |
| AC 010/14 | 14,5 cm/5 ³ / ₄ " |
| AC 010/15 | 15,5 cm/6" |
| AC 010/16 | 16,5 cm/6 ¹ / ₂ " |
| AC 010/17 | 17,5 cm/7" |
| AC 010/18 | 18,5 cm/7 ¹ / ₂ " |
| AC 010/20 | 20,0 cm/8" |

STANDARD

Fig.1
gebogen
curved
curvas
courbes
curve



STANDARD

Fig.2
gerade
straight
rectas
droits
rette

- | | |
|------------|---|
| AC 020/10 | 10,5 cm/4 ¹ / ₄ " |
| AC 020/11 | 11,5 cm/4 ¹ / ₂ " |
| AC 020/13* | 13,0 cm/5" |
| AC 020/14* | 14,5 cm/5 ³ / ₄ " |
| AC 020/15 | 15,5 cm/6" |
| AC 020/16 | 16,5 cm/6 ¹ / ₂ " |
| AC 020/17 | 17,5 cm/7" |
| AC 020/18 | 18,5 cm/7 ¹ / ₂ " |
| AC 020/20 | 20,0 cm/8" |

STANDARD

Fig.2
gebogen
curved
curvas
courbes
curve

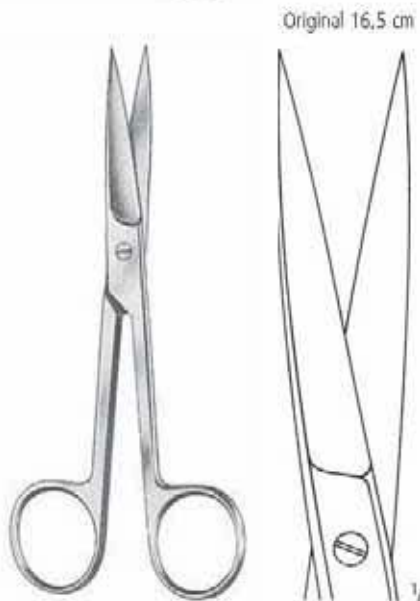

STANDARD

Fig.3
gerade
straight
rectas
droits
rette

- | | |
|-----------|---|
| AC 030/10 | 10,5 cm/4 ¹ / ₄ " |
| AC 030/11 | 11,5 cm/4 ¹ / ₂ " |
| AC 030/13 | 13,0 cm/5" |
| AC 030/14 | 14,5 cm/5 ³ / ₄ " |
| AC 030/15 | 15,5 cm/6" |
| AC 030/16 | 16,5 cm/6 ¹ / ₂ " |
| AC 030/17 | 17,5 cm/7" |
| AC 030/18 | 18,5 cm/7 ¹ / ₂ " |
| AC 030/20 | 20,0 cm/8" |

STANDARD

Fig.3
gebogen
curved
curvas
courbes
curve



SCHEREN SCISSORS TIJERAS CISEAUX FORBICI

Chirurgische Scheren
Operating Scissors
Tijeras para cirugía
Ciseaux à chirurgie
Forbici per chirurgia



Original 13,0 cm



GRAZIL

Fig. 1
gerade
straight
rectas
droits
rette

AC 040/13
AC 040/14

13,0 cm/5"
14,5 cm/5³/₄"

Original 13,0 cm



GRAZIL

Fig. 1
gebogen
curved
curvas
courbes
curve

AC 041/13
AC 041/14



Original 14,5 cm



GRAZIL

Fig. 2
gerade
straight
rectas
droits
rette

AC 042/13
AC 042/14

13,0 cm/5"
14,5 cm/5³/₄"

Original 14,5 cm



GRAZIL

Fig. 2
gebogen
curved
curvas
courbes
curve

AC 043/13
AC 043/14



Original 14,5 cm



GRAZIL

Fig. 3
gerade
straight
rectas
droits
rette

AC 046/13
AC 046/14

13,0 cm/5"
14,5 cm/5³/₄"

Original 14,5 cm



GRAZIL

Fig. 3
gebogen
curved
curvas
courbes
curve

AC 047/13
AC 047/14



AA
AB
AC
AD
AE
AF
AK
AL
AO
AP
AR
KA
KL
KM
KO
KU
KYE
X

AC SCHEREN SCISSORS TIJERAS CISEAUX FORBICI

Chirurgische Scheren
 Operating Scissors
 Tijeras para cirugía
 Ciseaux à chirurgie
 Forbici per chirurgia



Inzisionsscheren
 Incision Scissors
 Tijeras para incision
 Ciseaux à incision
 Forbici per incisioni

AC 052/13 = 13,0 cm/5"
 AC 052/14 = 14,5 cm/5³/₄"



AC 054/15
 15,5 cm/6"



RICHTER
 AC 056/14
 14,5 cm/5³/₄"



DEAVER
 AC 060/14
 14,0 cm/5¹/₂"



AC 061/14



AC 062/15
MIXTER
 15,5 cm/6"

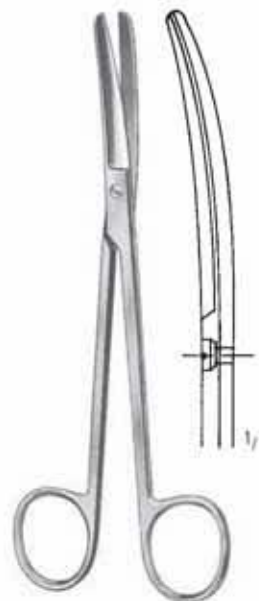

AC 063/15

SCHEREN SCISSORS TIJERAS CISEAUX FORBICI

Chirurgische Scheren, Präparierscheren
 Operating Scissors, Dissecting Scissors
 Tijeras para cirugía, Tijeras para preparaciones
 Ciseaux à chirurgie, Ciseaux à dissection
 Forbici per chirurgia, Forbici per preparazioni

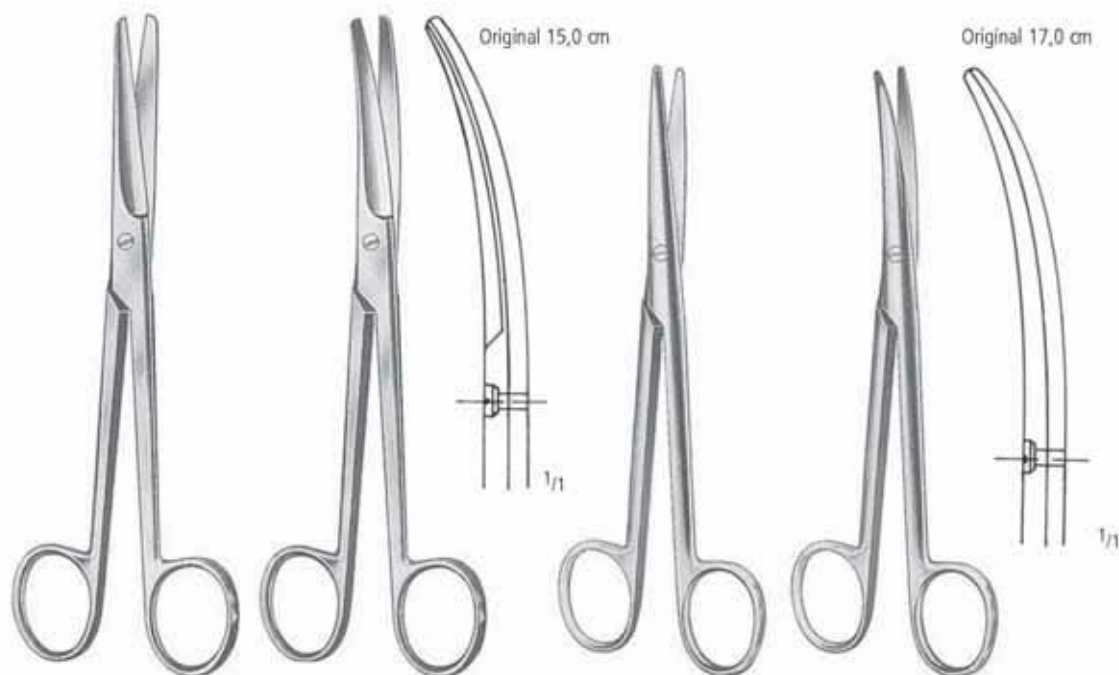

	MAYO		MAYO-STILLE	
14,5 cm/5 ³ / ₄ "	AC 070/14*	AC 071/14*		
15,0 cm/6"			AC 072/15	AC 073/15
17,0 cm/6 ³ / ₄ "	AC 070/17*	AC 071/17*	AC 072/17*	AC 073/17*
19,5 cm/7 ³ / ₄ "			AC 072/19	AC 073/19

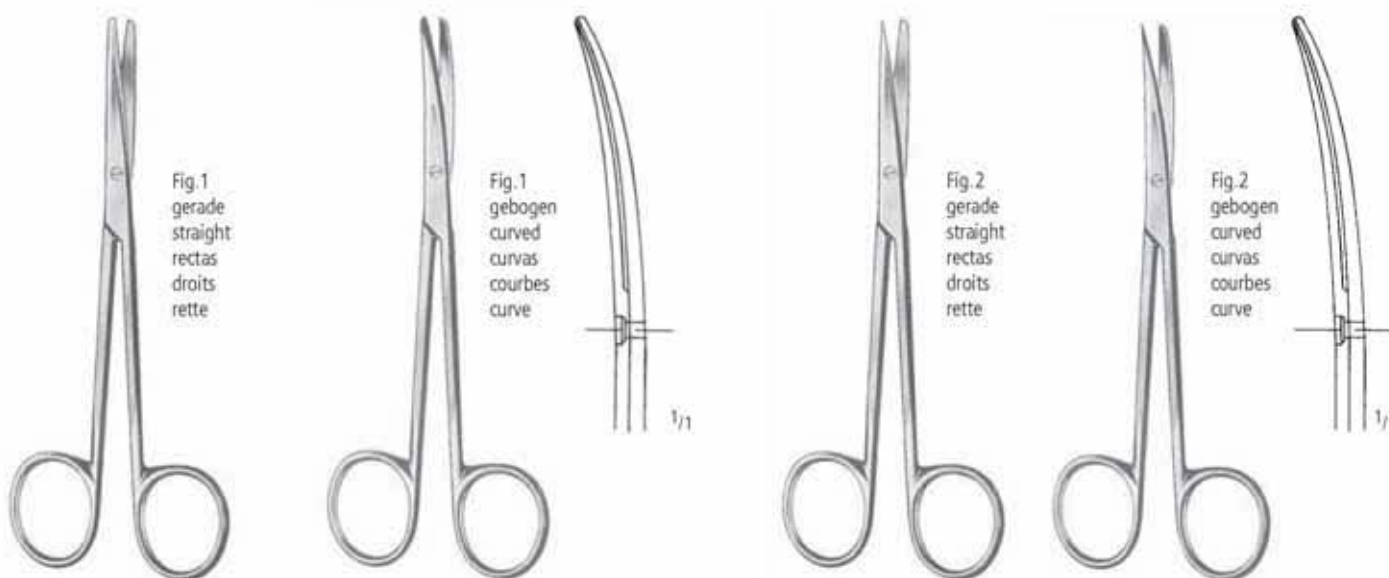

METZENBAUM		METZENBAUM	
AC 100/14*	AC 101/14*	AC 102/14	AC 103/14
14,5 cm/5 ³ / ₄ "	14,5 cm/5 ³ / ₄ "	14,5 cm/5 ³ / ₄ "	14,5 cm/5 ³ / ₄ "

* Auch erhältlich als SC * Also available as SC

AA
AB
AC
AD
AE
AF
AK
AL
AO
AP
AR
KA
KL
KM
KO
KU
KYE
X

Präparierscheren
Dissecting Scissors
Tijeras para preparaciones
Ciseaux à dissection
Forbici per preparazioni

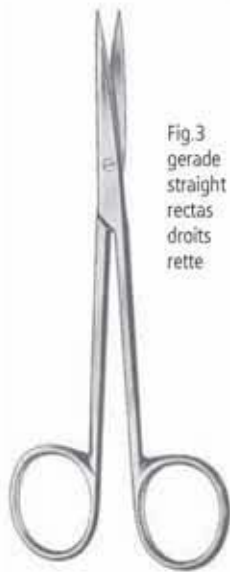

Fig.3
gerade
straight
rectas
droits
rette

AC 104/14
14,5 cm/5³/₄"

METZENBAUM

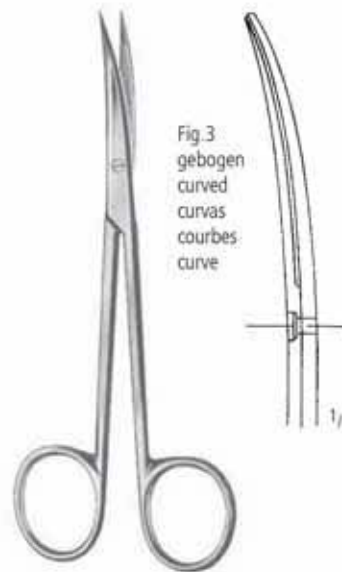

Fig.3
gebogen
curved
curvas
courbes
curve

AC 105/14
14,5 cm/5³/₄"



gerade
straight
rectas
droits
rette

AC 108/11

METZENBAUM-BABY

11,5 cm/4¹/₂"

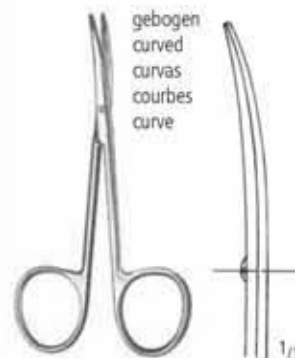

gebogen
curved
curvas
courbes
curve

AC 109/11

SCHEREN SCISSORS TIJERAS CISEAUX FORBICI

Präparierscheren
 Dissecting Scissors
 Tijeras para preparaciones
 Ciseaux à dissection
 Forbici per preparazioni



METZENBAUM-NELSON

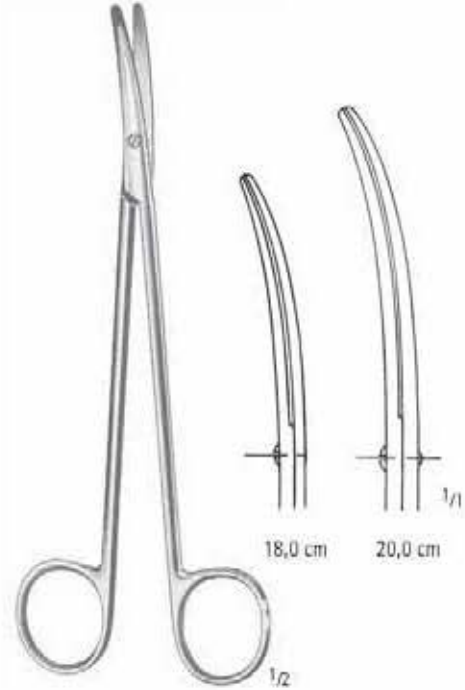

METZENBAUM-NELSON



Fig. 1

Fig. 2

Fig. 3

18,0 cm/7"	AC 110/18*	AC 111/18*	AC 120/18	AC 121/18	AC 130/18	AC 131/18
20,0 cm/8"	AC 110/20*	AC 111/20*	AC 120/20	AC 121/20	AC 130/20	AC 131/20

AA
 AB
AC
 AD
 AE
 AF
 AG
 AH
 AI
 AJ
 AK
 AL
 AM
 AN
 AO
 AP
 AQ
 AR
 AS
 AT
 AU
 AV
 AW
 AX

Präparierscheren, DELICATE
 Dissecting Scissors, DELICATE
 Tijeras para preparaciones, DELICATE
 Ciseaux à dissection, DELICATE
 Forbici per preparazioni, DELICATE

METZENBAUM-DELICATE

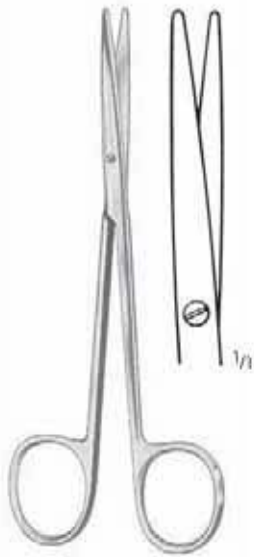

Fig. 1
 AC 140/14*
 14,5 cm/5³/₄"



Fig. 1
 AC 141/14*
 14,5 cm/5³/₄"



Fig. 3
 AC 142/14*
 14,5 cm/5³/₄"

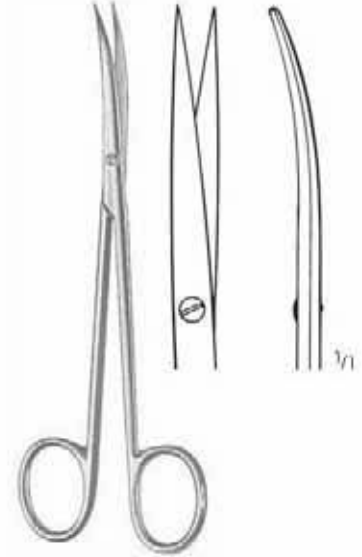

Fig. 3
 AC 143/14*
 14,5 cm/5³/₄"

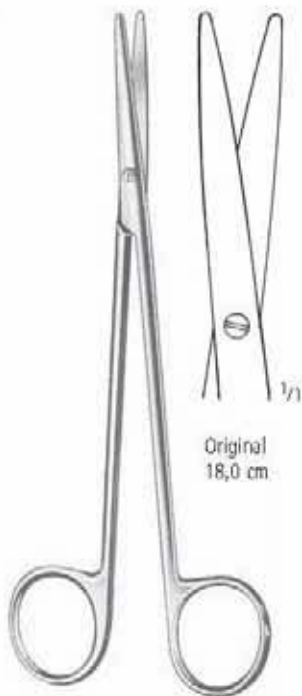

Fig. 1

Original
 18,0 cm

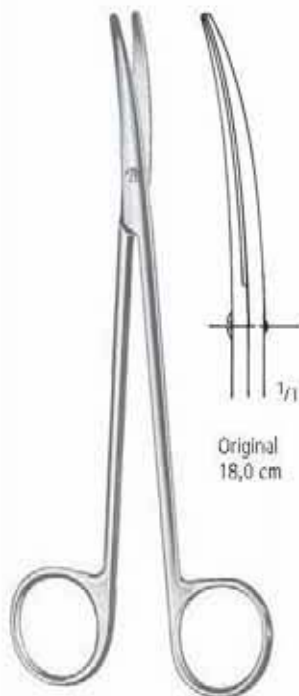

Fig. 1

Original
 18,0 cm

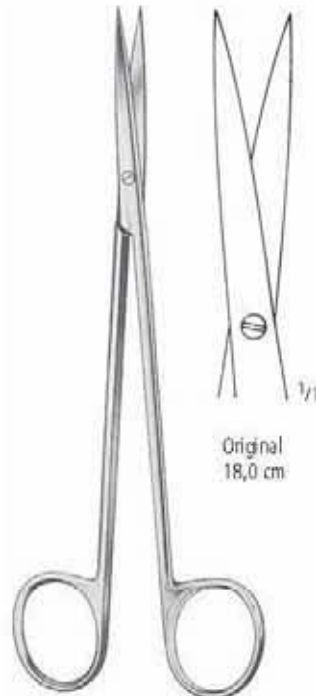

Fig. 3

Original
 18,0 cm

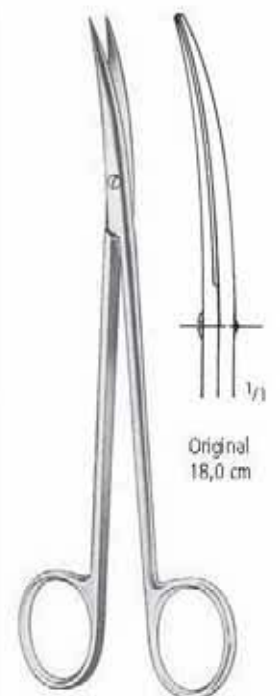

Fig. 3

Original
 18,0 cm

18,0 cm/7"	AC 150/18*	AC 151/18*	AC 152/18*	AC 153/18*
20,0 cm/8"	AC 150/20*	AC 151/20*	AC 152/20*	AC 153/20*

SCHEREN SCISSORS TIJERAS CISEAUX FORBICI

Präparierscheren
Dissecting Scissors
Tijeras para preparaciones
Ciseaux à dissection
Forbici per preparazioni

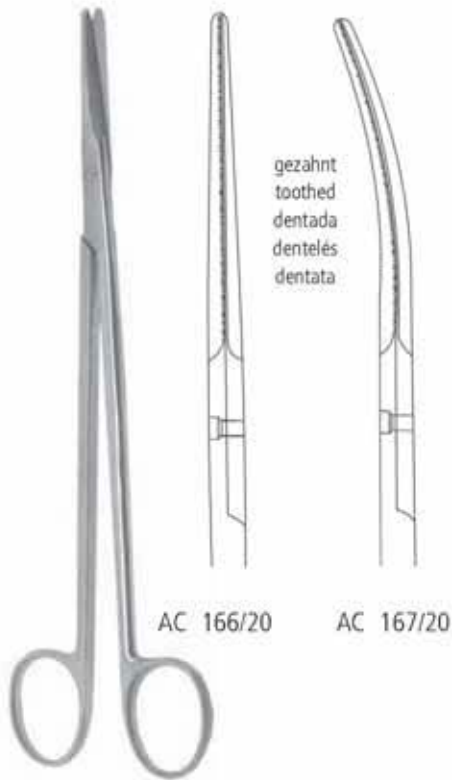

GORNEY
19,5 cm/7³/₄"

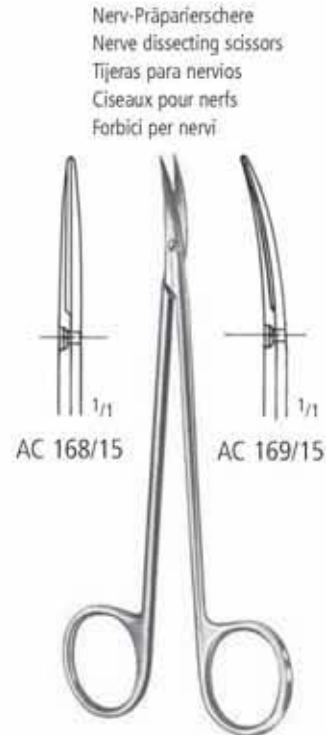

15,0 cm/6"



LEXER
AC 170/16
16,0 cm/6¹/₄"



LEXER
AC 171/16
16,0 cm/6¹/₄"



FOMON
AC 173/13
13,5 cm/5¹/₄"



THOREK
AC 175/19
19,0 cm/7¹/₂"

AA
AB
AC
AD
AE
AF
AG
AH
AI
AJ
AK
AL
AM
AN
AO
AP
AQ
AR
AS
AT
AU
AV
AW
AX

Präparierscheren
Dissecting Scissors
Tijeras para preparaciones
Ciseaux à dissection
Forbici per preparazioni



LEXER-BABY
AC 176/10
10,0 cm/4"

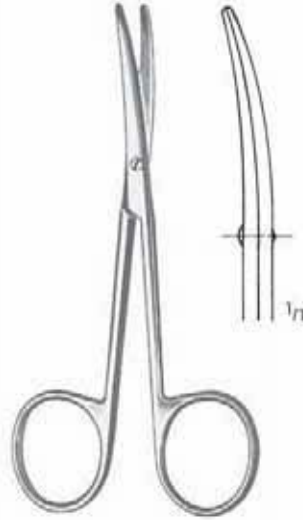

LEXER-BABY
AC 177/10
10,0 cm/4"



AC 200/14
14,0 cm/5 1/2"



SANVENERO
AC 201/14
14,0 cm/5 1/2"



AC 204/14
14,0 cm/5 1/2"

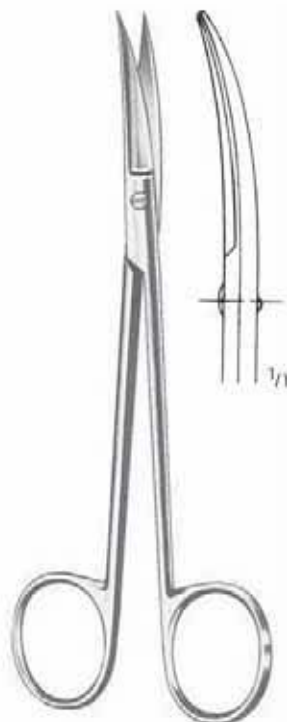

JOSEPH
AC 205/14
14,0 cm/5 1/2"



KILNER (RAGNELL)
AC 208/12 12,0 cm/4 3/4"
AC 208/15 15,0 cm/6"
AC 208/18 18,0 cm/7"
AC 208/20 20,0 cm/8"

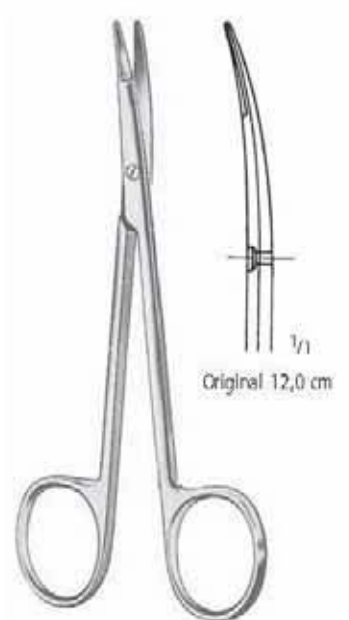

AC 210/12
AC 210/15
AC 210/18
AC 210/20

SCHEREN SCISSORS TIJERAS CISEAUX FORBICI

Präparierscheren, Tonsillenscheren
 Dissecting Scissors, Tonsil Scissors
 Tijeras para preparaciones, Tijeras para amígdalas
 Ciseaux à dissection, Ciseaux pour les amygdales
 Forbici per preparazioni, Forbici per tonsille

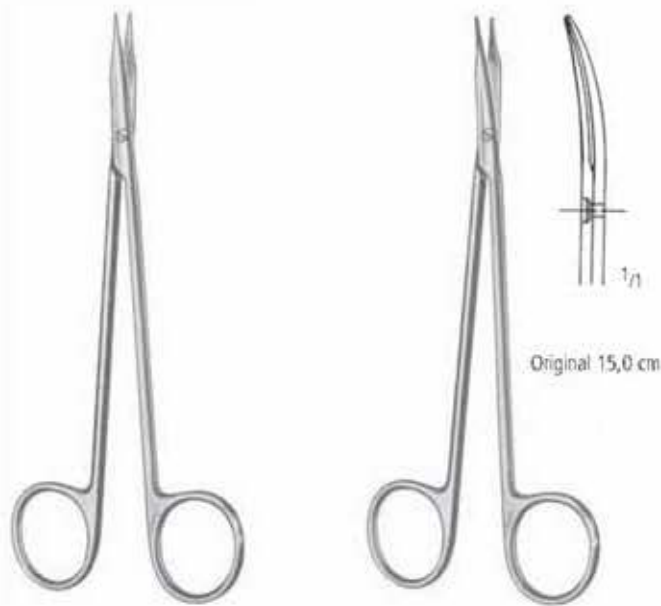

REYNOLDS

AC 214/15*	15,0 cm/6"	AC 215/15*
AC 214/18*	18,0 cm/7"	AC 215/18*



PRINCE
 AC 301/17
 17,5 cm/7"

BÖTTCHER
 AC 302/18
 18,0 cm/7"

GOOD
 AC 303/19
 19,0 cm/7½"

GOOD-SCHWECKENDICK
 AC 304/19
 19,0 cm/7½"

AA
 AB
AC
 AD
 AE
 AF
 AK
 AL
 AO
 AP
 AR
 KA
 KL
 KM
 KO
 KU
 KYE
 X

AC SCHEREN SCISSORS TIJERAS CISEAUX FORBICI

Nasenscheren, Kropfschere
 Nasal Scissors, Goitre Enucleation Scissors
 Tijeras nasales, Tijeras para bocio
 Ciseaux nasaux, Ciseaux à goitre
 Forbici nasali, Forbici per gozzo

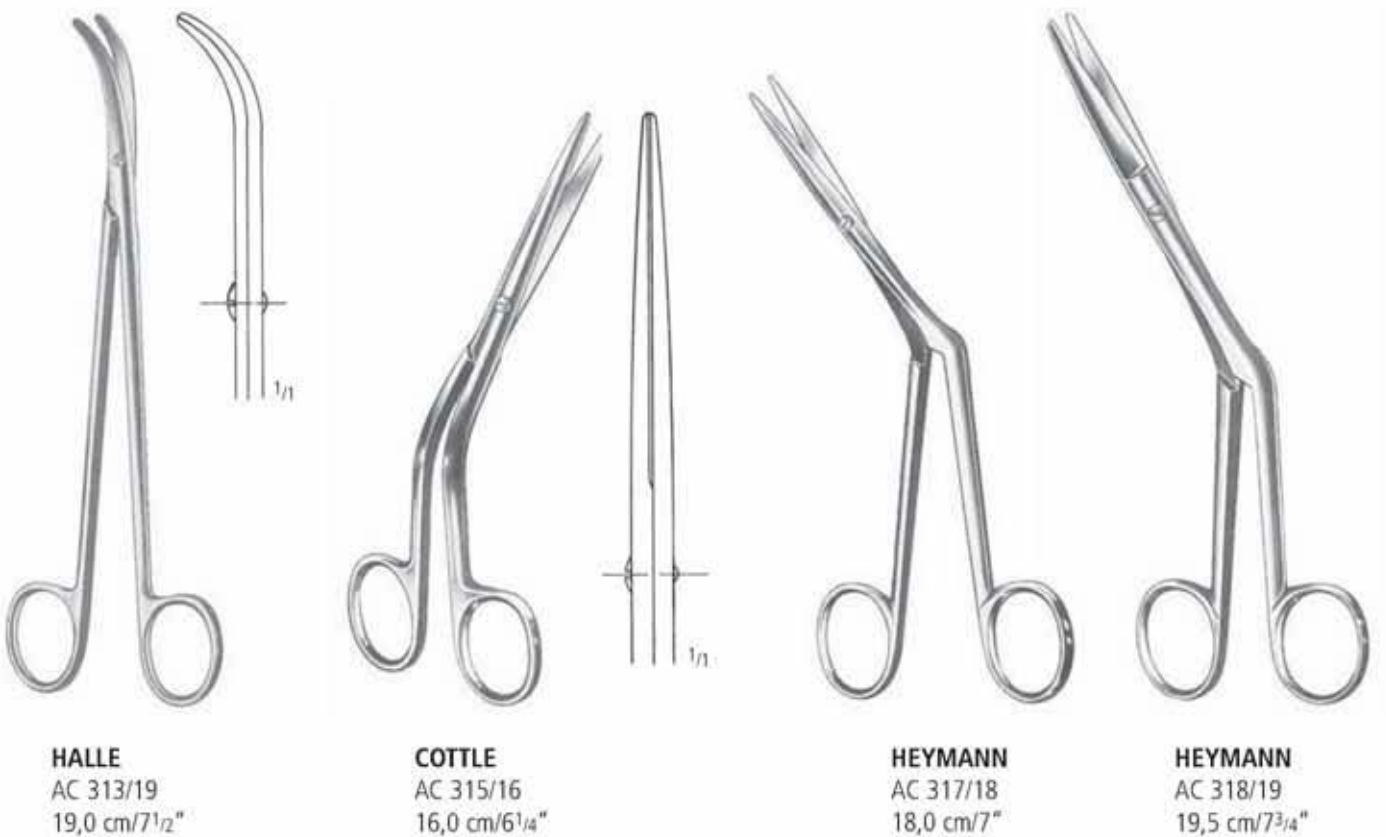
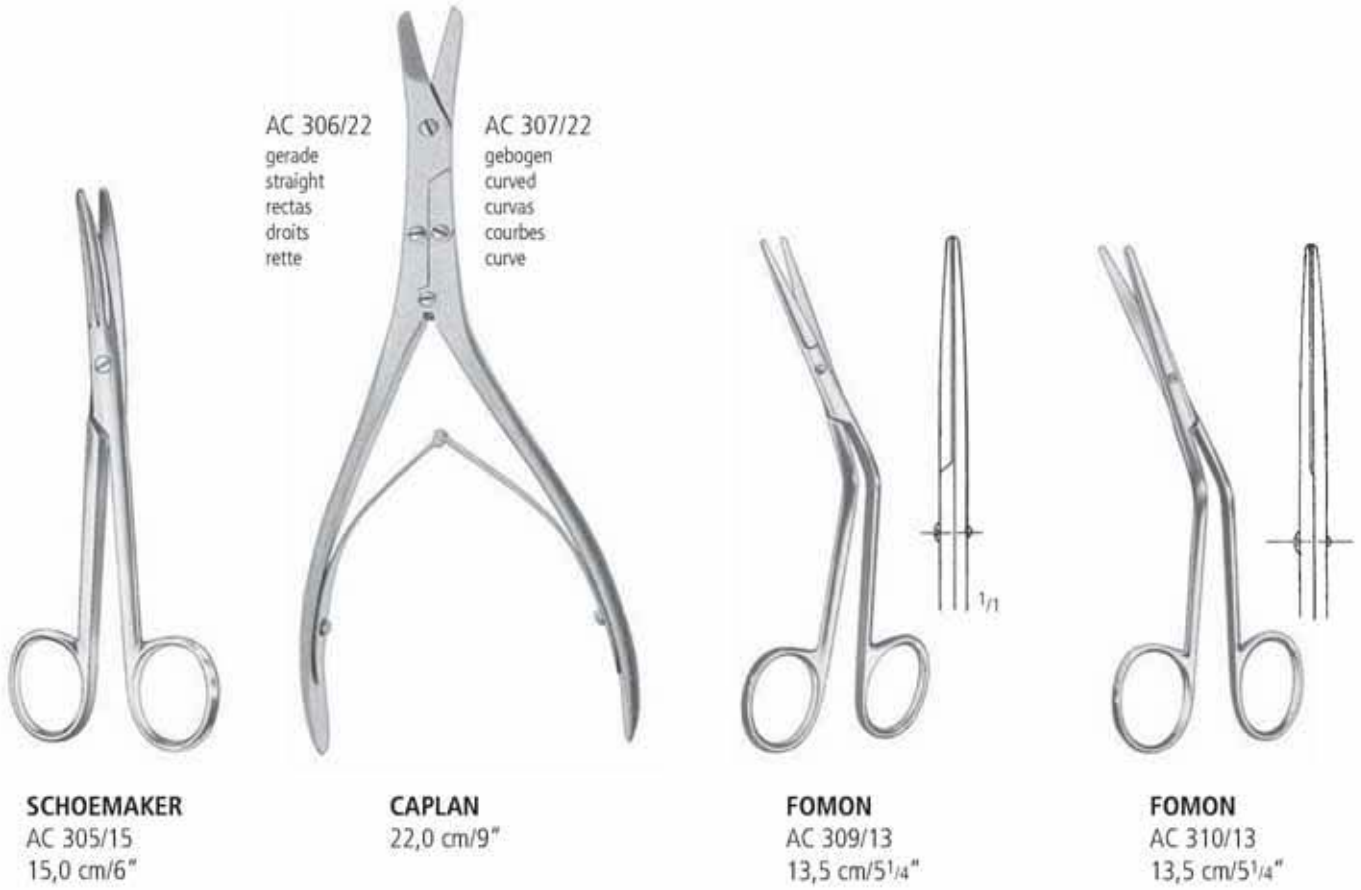

SCHEREN SCISSORS TIJERAS CISEAUX FORBICI

Feine chirurgische Scheren
 Fine Operating Scissors
 Tijeras finas para cirugía
 Ciseaux fins à chirurgie
 Forbici fini per chirurgia



WAGNER
 12,0 cm/4³/₄"

gerade
 straight
 rectas
 droits
 retle



Fig. 1
 AC 404/01



Fig. 2
 AC 404/02



Fig. 3
 AC 404/03

gebogen
 curved
 curvas
 courbes
 curve



Fig. 1
 AC 405/01



Fig. 2
 AC 405/02



Fig. 3
 AC 405/03



AC 408/11
 11,0 cm/4¹/₃"



AC 409/11
 11,0 cm/4¹/₃"

AA
 AB
AC
 AD
 AE
 AF
 AG
 AH
 AI
 AJ
 AK
 AL
 AM
 AN
 AO
 AP
 AQ
 AR
 AS
 AT
 AU
 AV
 AW
 AX

AC SCHEREN SCISSORS TIJERAS CISEAUX FORBICI

Feine Scheren
 Fine Scissors
 Tijeras finas
 Ciseaux fins
 Forbici fini

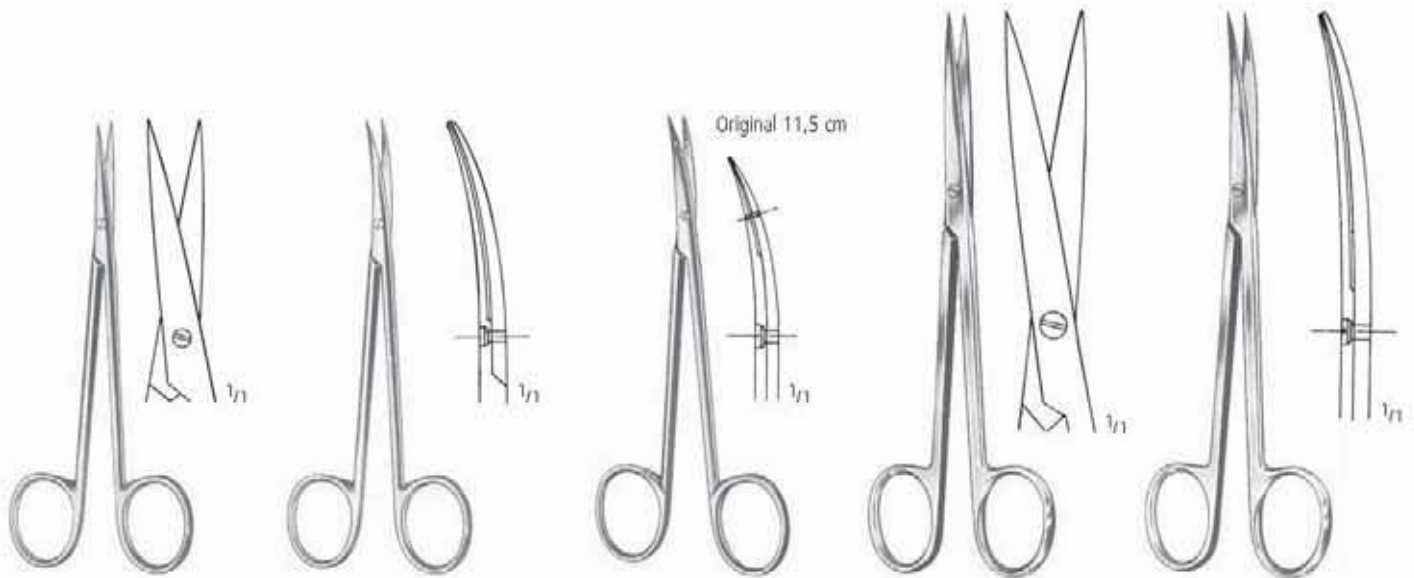

AC 410/11
 11,5 cm/4 1/2"

AC 411/11
 11,5 cm/4 1/2"

LITTLER
 AC 412/11 11,5 cm/4 1/2"
 AC 412/14 14,0 cm/5 1/2"

BROPHY (SULLIVAN)
 AC 414/14 14,5 cm/5 3/4"
 AC 415/14 14,5 cm/5 3/4"



AC 418/13
 13,0 cm/5"

AC 422/10 10,5 cm/4 1/4"
 AC 422/11 11,5 cm/4 1/2"

AC 423/10
 AC 423/11

AC 424/11
 11,5 cm/4 1/2"

SCHEREN SCISSORS TIJERAS CISEAUX FORBICI

Feine Scheren
Fine Scissors
Tijeras finas
Ciseaux fins
Forbici fini

AA

AB

AC

AD

AE

AF

AK

AL

AO

AP

AR

KA

KL

KM

KO

KU

KYE

X

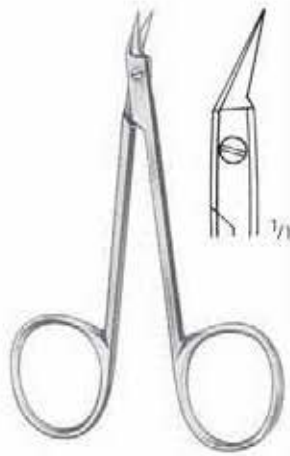

O'BRIEN
AC 427/09
9,0 cm/3 1/2"

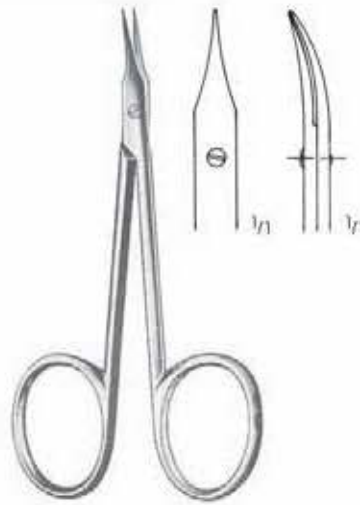

WALTON
AC 429/10
10,0 cm/4"

sehr fein
extra delicate
muy finas
tres fin
molto sottile

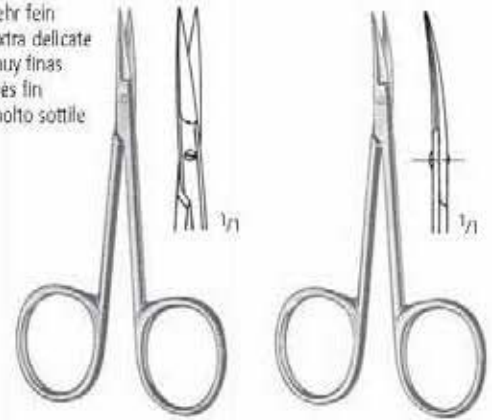

MOD. BONN
AC 430/08 AC 431/08
8,0 cm/3" 8,0 cm/3"

Irisscheren
Iris Scissors
Tijeras para iridectomia
Ciseaux à iridectomie
Forbici per iridectomia

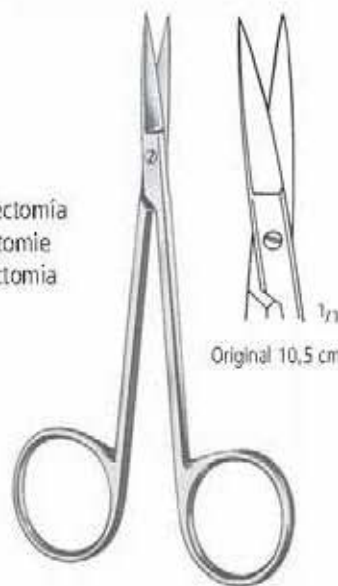

Original 10,5 cm



Original 10,5 cm

9,0 cm/3 1/2"	AC 450/09	AC 451/09
10,5 cm/4 1/4"	AC 450/10	AC 451/10
11,5 cm/4 1/2"	AC 450/11	AC 451/11

AC SCHEREN SCISSORS TIJERAS CISEAUX FORBICI

Feine Scheren, Ligaturscheren
 Fine Scissors, Ligature Scissors
 Tijeras finas, Tijeras para ligaduras
 Ciseaux fins, Ciseaux à ligatures
 Forbici fini, Forbici per legatura

Original 11,5 cm



CHADWICK
 AC 473/11
 11,0 cm/4 1/3"



STEVENS
 10,5 cm/4 1/4"
 11,5 cm/4 1/2"

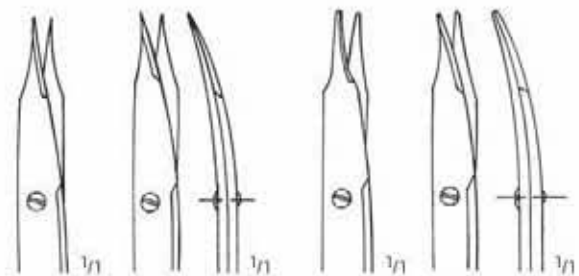

spliz pointed agudas pointues acuta	gerade straight rectas droits rette	gebogen curved curvas courbes curve	stumpf blunt romas mousses smussa	gerade straight rectas droits rette	gebogen curved curvas courbes curve
---	---	---	---	---	---

AC 474/10	AC 475/10	AC 476/10	AC 477/10
AC 474/11	AC 475/11	AC 476/11*	AC 477/11



SPENCER
 9,0 cm/3 1/2"
 10,5 cm/4 1/4"
 12,5 cm/5"



SPENCER-DELICATE
 AC 501/11
 11,0 cm/4 1/3"



LITTAUER
 AC 502/14
 14,0 cm/5 1/2"



AC 503/16
 16,0 cm/6 1/4"

SCHEREN SCISSORS TIJERAS CISEAUX FORBICI

Ligaturscheren
 Ligature Scissors
 Tijeras para ligaduras
 Ciseaux à ligatures
 Forbici per legatura

AA
 AB
AC
 AD
 AE
 AF
 AG
 AH
 AI
 AJ
 AK
 AL
 AM
 AN
 AO
 AP
 AQ
 AR
 AS
 AT
 AU
 AV
 AW
 AX



SHORTBENT
 AC 513/09
 9,0 cm/3 1/2"



NORTHBENT
 AC 514/12
 12,5 cm/5"



BUCK
 14,5 cm/5 3/4" AC 516/14
 18,0 cm/7" AC 516/18

SCHEREN SCISSORS TIJERAS CISEAUX FORBICI

Mikroscheren
Micro Scissors
Micro Tijeras
Micro Ciseaux
Micro Forbici

- >> Alle unsere Mikroscheren werden von Fachkräften mit jahrelanger Erfahrung hergestellt. Die Endkontrolle findet unter dem Mikroskop statt. Um Ihnen ein ermüdungsfreies Arbeiten zu ermöglichen, wird dem Federdruck größte Aufmerksamkeit gewidmet.
- >> Bitte wählen Sie unter Rund- oder Flachgriffscheren.



Dissection: **Gebogene Blätter, abgerundete Spitzen** ermöglichen eine gute und sichere Dissektion, ohne Nerven und Blutgefäße zu beschädigen.



Adventitia: **Gerade Blätter, sehr scharfe Spitzen** gewährleisten präzises Anfrischen von Gefäßenden.

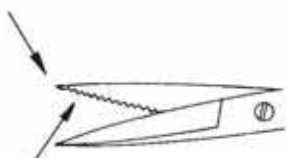

Nerve: Ein Blatt ist **fein gezahnt**, um ein Herausgleiten des Nervs zu vermeiden.

- >> All our Micro Scissors are manufactured by skilled craftsmen with many years of experience. Final inspection is carried out under a microscope. Careful attention is paid to the closing pressure of the spring handle, to ensure precise work during surgeries, without fatigue.
- >> Round or flat handle scissors according to your preference.

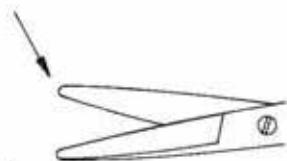

Dissection: **Curved blades, slightly rounded tips** ensure safe dissection without damage to nerves and vessels.

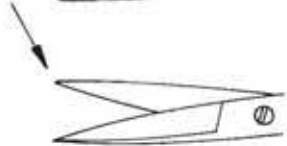

Adventitia: **Straight blades, very sharp tips** for finest trimming of vessel ends.

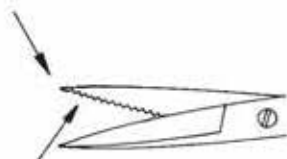

Nerve: One blade is **fine-toothed** to avoid slipping of the nerve.

AA

AB

AC

AD

AE

AF

AK

AL

AO

AP

AR

KA

KL

KM

KO

KU

KYE

X

AC SCHEREN SCISSORS TIJERAS CISEAUX FORBICI

Mikroscheren
Micro Scissors
Micro Tijeras
Micro Ciseaux
Micro Forbici



14,5 cm/5³/₄"



Dissection
AC 801/15



Adventitia
AC 803/15



18,0 cm/7"



Dissection
AC 801/18



Adventitia
AC 803/18

SCHEREN SCISSORS TIJERAS CISEAUX FORBICI

Mikroscheren
Micro Scissors
Micro Tijeras
Micro Ciseaux
Micro Forbici

AA

AB

AC

AD

AE

AF

AK

AL

AO

AP

AR

KA

KL

KM

KO

KU

KYE

X



AC 807/14
14,5 cm/5³/₄"



AC 812/18
18,0 cm/7"



AC 817/18
18,0 cm/7"

AC SCHEREN SCISSORS TIJERAS CISEAUX FORBICI

Mikroscheren
Micro Scissors
Micro Tijeras
Micro Ciseaux
Micro Forbici



11,0 cm/4¹/₃"

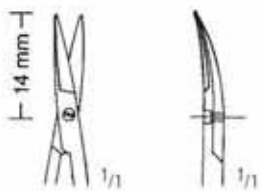

Dissection
AC 821/11

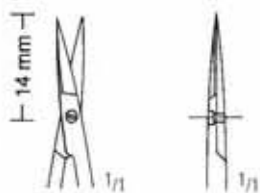

Adventitia
AC 830/11



15,0 cm/6"

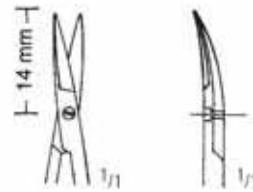

Dissection
AC 823/15

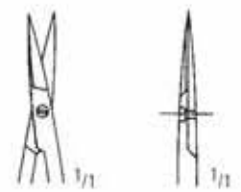

Adventitia
AC 832/15

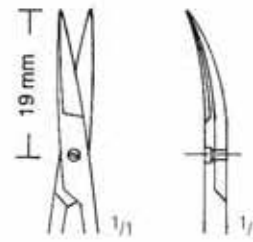

Dissection
AC 825/15

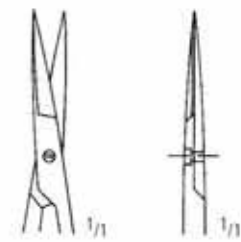

Adventitia
AC 834/15

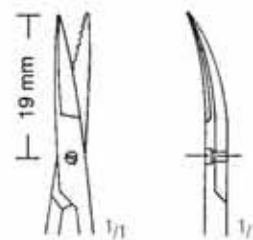

Dissection
AC 827/15

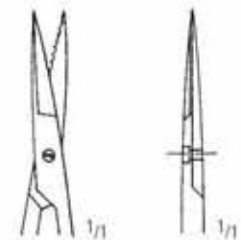

Adventitia
AC 836/15

>> Nerve >>

SCHEREN SCISSORS TIJERAS CISEAUX FORBICI

Mikroscheren
Micro Scissors
Micro Tijeras
Micro Ciseaux
Micro Forbici

AA
AB
AC
AD
AE
AF
AG
AH
AI
AJ
AK
AL
AM
AN
AO
AP
AQ
AR
AS
AT
AU
AV
AW
AX



18,5 cm/7¹/₃"



AC 850/19



AC 851/19



16,0 cm/6¹/₄"
20,0 cm/8"



AC 860/16
AC 860/20



AC 861/16
AC 861/20



AC 862/16
AC 862/20



AC 863/16
AC 863/20



AC 864/16
AC 864/20



AC 865/16
AC 865/20

AC SCHEREN SCISSORS TIJERAS CISEAUX FORBICI

Mikroscheren
Micro Scissors
Micro Tijeras
Micro Ciseaux
Micro Forbici



18,0 cm/7"



AC 870/01
25°



AC 870/02
45°



AC 870/03
60°



AC 870/04
90°



AC 870/05
125°



18,0 cm/7"



AC 871/01
25°



AC 871/02
45°



AC 871/03
60°



AC 871/04
90°



AC 871/05
125°

nopa[®]TUC[®]
SC Super Cut
SUPER CUT TUC



SUPER CUT TUC

Besonderheit:

Nutzen Sie die Vorteile von Hartmetalleinsätzen.

nopa TUC Super Cut Scheren haben eine rasierklingscharfe Schneide, kombiniert mit einer mikrogezahnten Schneide.

>> Diese Scheren sind durch schwarz/goldene Ringe gekennzeichnet.

Features:

Use the advantages of Tungsten Carbide.

nopa TUC Super Cut scissors have a razor-like edge combined with one micro serrated blade.

>> Black/golden rings for easy identification.

Verfügbare Modelle / Available Patterns

Im Katalog durch * markiert. / Marked in the catalog with *.

- AC 902/14 SC STANDARD SCS.TUC STR.SH/BL 14,5 CM SC
- AC 903/14 SC STANDARD SCS.TUC CVD.SH/BL 14,5 CM SC
- AC 910/14 SC MAYO DISS.SCS.TUC STR.BL/BL 14,5 CM SC
- AC 910/17 SC MAYO DISS.SCS.TUC STR.BL/BL 17,0 CM SC
- AC 911/14 SC MAYO DISS.SCS.TUC CVD.BL/BL 14,5 CM SC
- AC 911/17 SC MAYO DISS.SCS.TUC CVD.BL/BL 17,0 CM SC
- AC 916/15 SC MAYO-STILLE SCS.TUC STR.BL/BL 15,0 CM SC
- AC 916/17 SC MAYO-STILLE SCS.TUC STR.BL/BL 17,0 CM SC
- AC 917/15 SC MAYO-STILLE SCS.TUC CVD.BL/BL 15,0 CM SC
- AC 917/17 SC MAYO-STILLE SCS.TUC CVD.BL/BL 17,0 CM SC
- AC 930/14 SC METZENBAUM SCS.TUC STR.BL/BL 14,5 CM SC
- AC 931/14 SC METZENBAUM SCS.TUC CVD.BL/BL 14,5 CM SC
- AC 940/18 SC METZENBAUM SCS.TUC STR.BL/BL 18,0 CM SC
- AC 940/20 SC METZENBAUM SCS.TUC STR.BL/BL 20,0 CM SC
- AC 941/18 SC METZENBAUM SCS.TUC CVD.BL/BL 18,0 CM SC
- AC 941/20 SC METZENBAUM SCS.TUC CVD.BL/BL 20,0 CM SC
- AC 953/16 SC LEXER SCISSORS CVD.BL/BL 16,0 CM SC
- AC 960/14 SC METZENBAUM-DELIC.TUC STR.BL/BL 14,5 CM SC
- AC 961/14 SC METZENBAUM-DELIC.TUC CVD.BL/BL 14,5 CM SC
- AC 970/18 SC METZENBAUM-DELIC.SCS.TUC STR.BL/BL 18,0 CM SC
- AC 970/20 SC METZENBAUM-DELIC.SCS.TUC STR.BL/BL 20,0 CM SC
- AC 971/18 SC METZENBAUM-DELIC.SCS.TUC CVD.BL/BL 18,0 CM SC
- AC 971/20 SC METZENBAUM-DELIC.SCS.TUC CVD.BL/BL 20,0 CM SC
- AC 974/11 SC STEVENS TENOTOM.SCS.TUC STR.SH/SH 11,5CM SC
- AC 975/11 SC STEVENS TENOTOM.SCS.TUC CVD.SH/SH 11,5 CM SC
- AC 976/11 SC STEVENS TENOTOM.SCS.TUC STR.BL/BL 11,5 CM SC
- AC 977/11 SC TENOTOMY SCISSORS TUC CVD.BL/BL 11,5 CM SC
- AC 984/11 SC IRIS SCS.TUC STR.SH/SH 11,5 CM SC
- AC 985/11 SC IRIS SCS.TUC CVD.SH/SH 11,5 CM SC

AA
AB
AC
AD
AE
AF
AK
AL
AO
AP
AR
KA
KL
KM
KO
KU
KYE
X

AC SCHEREN SCISSORS TIJERAS CISEAUX FORBICI

Scheren mit Hartmetalleinlagen
 Scissors with Tungsten Carbide Inserts
 Tijeras con filos de carburo de tungsteno
 Ciseaux avec plaquettes en carbure de tungstène
 Forbici con taglio al carburo di tungsteno

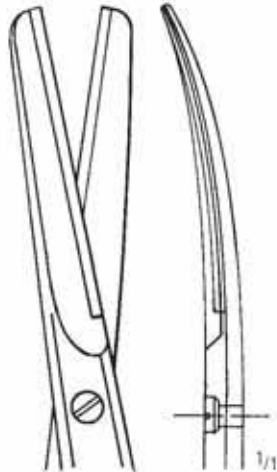

STANDARD
 Fig. 1

straight: 14,5 cm/5³/₄"
 AC 900/14
 curved: AC 901/14

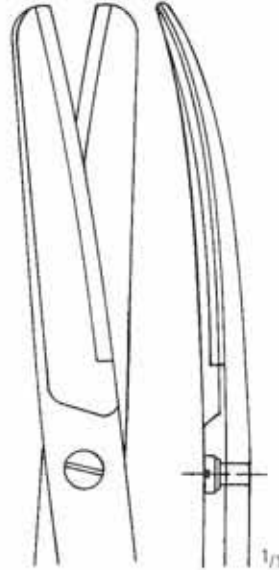

16,5 cm/6¹/₂"
 AC 900/16
 AC 901/16

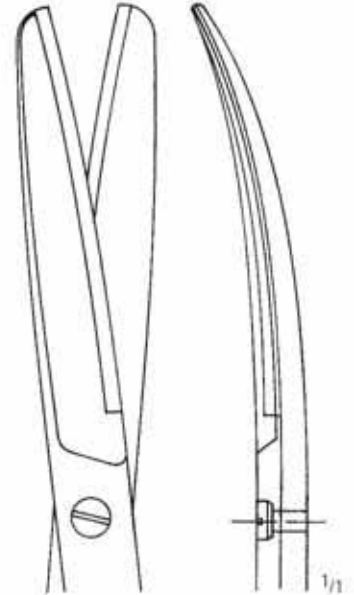

18,5 cm/7¹/₃"
 AC 900/18
 AC 901/18

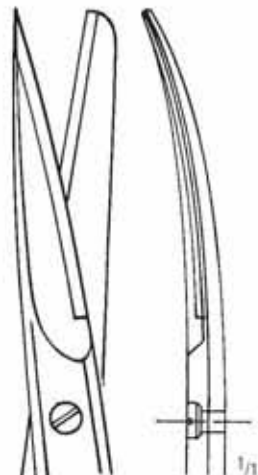

STANDARD
 Fig. 2

straight: 14,5 cm/5³/₄"
 AC 902/14*
 curved: AC 903/14*

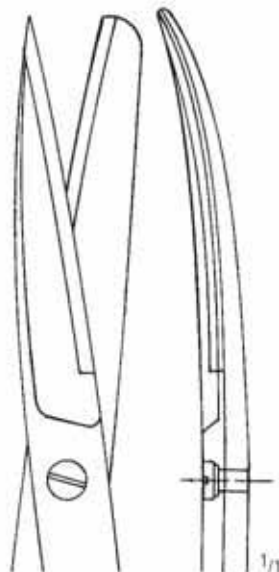

16,5 cm/6¹/₂"
 AC 902/16
 AC 903/16

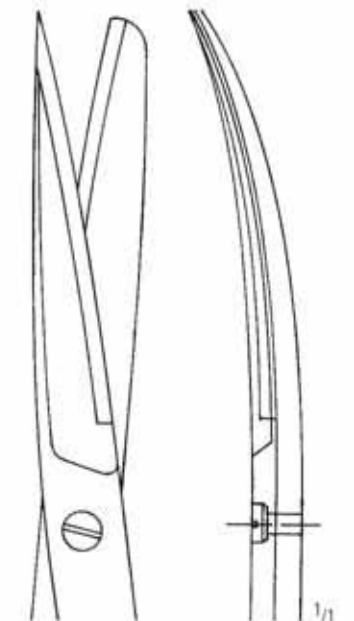

18,5 cm/7¹/₃"
 AC 902/18
 AC 903/18

SCHEREN SCISSORS TIJERAS CISEAUX FORBICI

Scheren mit Hartmetalleinlagen
 Scissors with Tungsten Carbide Inserts
 Tijeras con filos de carburo de tungsteno
 Ciseaux avec plaquettes en carbure de tungstène
 Forbici con taglio al carburo di tungsteno

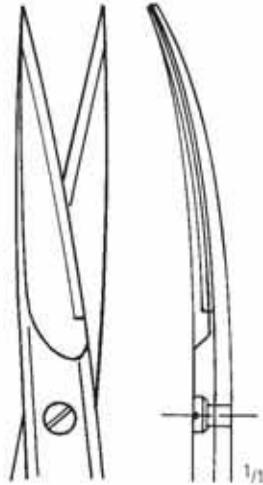

STANDARD
 Fig. 3

straight: 14,5 cm/5³/₄"
 AC 904/14
 curved: AC 905/14

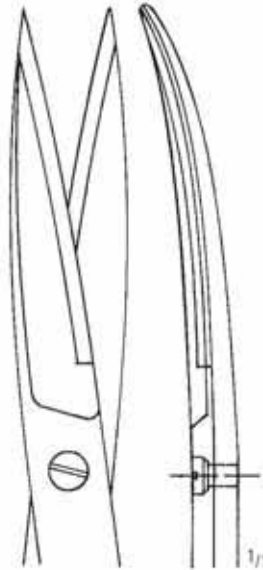

16,5 cm/6¹/₂"
 AC 904/16
 AC 905/16

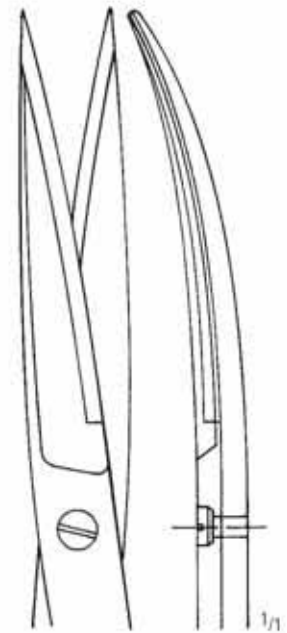

18,5 cm/7¹/₃"
 AC 904/18
 AC 905/18

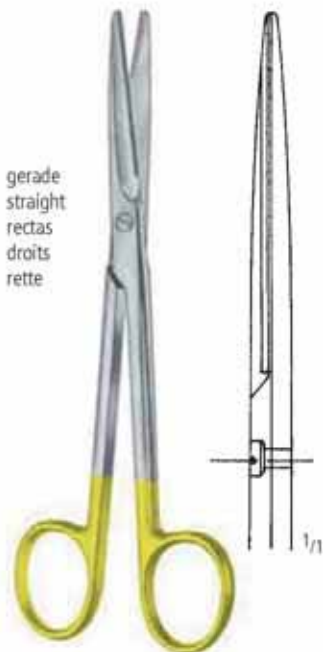

gerade
 straight
 rectas
 droits
 rette

MAYO
 AC 910/14*
 AC 910/17*

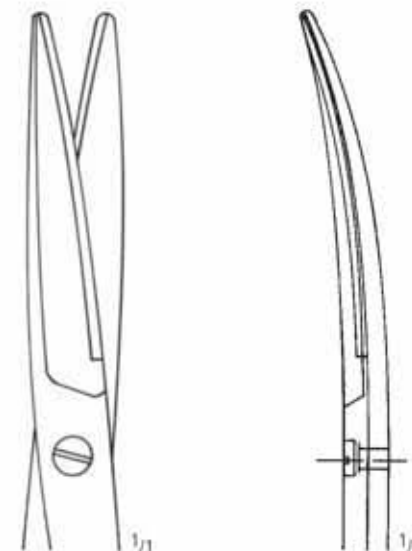

Original 17,0 cm

14,5 cm/5¹/₂"
 17,0 cm/6³/₄"



gebogen
 curved
 curvas
 courbes
 curve

MAYO
 AC 911/14*
 AC 911/17*

AA
 AB
 AC
 AD
 AE
 AF
 AG
 AH
 AI
 AJ
 AK
 AL
 AM
 AN
 AO
 AP
 AQ
 AR
 AS
 AT
 AU
 AV
 AW
 AX

AC SCHEREN SCISSORS TIJERAS CISEAUX FORBICI

Scheren mit Hartmetalleinlagen
 Scissors with Tungsten Carbide Inserts
 Tijeras con filos de carburo de tungsteno
 Ciseaux avec plaquettes en carbure de tungstène
 Forbici con taglio al carburo di tungsteno



MAYO-STILLE
 AC 916/15*
 AC 916/17*



Original 17,0 cm

15,0 cm/6"
 17,0 cm/6³/₄"



MAYO-STILLE
 AC 917/15*
 AC 917/17*

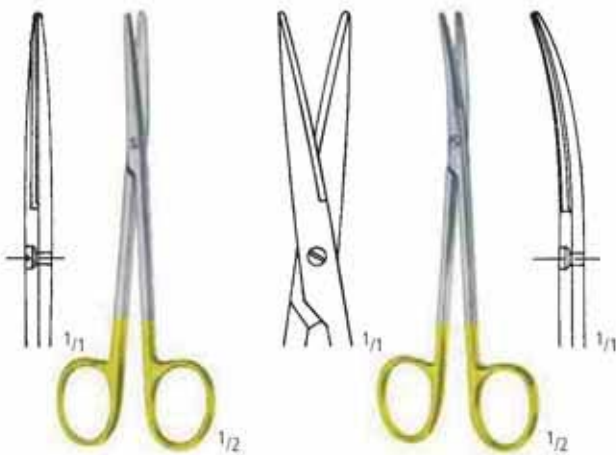

METZENBAUM
 AC 922/11
 11,5 cm/4¹/₂"
 AC 923/11
 11,5 cm/4¹/₂"

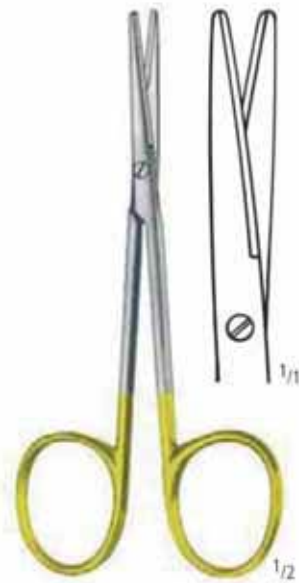

METZENBAUM
 AC 930/14*
 14,5 cm/5³/₄"



METZENBAUM
 AC 931/14*
 14,5 cm/5³/₄"

SCHEREN SCISSORS TIJERAS CISEAUX FORBICI

Scheren mit Hartmetalleinlagen
 Scissors with Tungsten Carbide Inserts
 Tijeras con filos de carburo de tungsteno
 Ciseaux avec plaquettes en carbure de tungstène
 Forbici con taglio al carburo di tungsteno

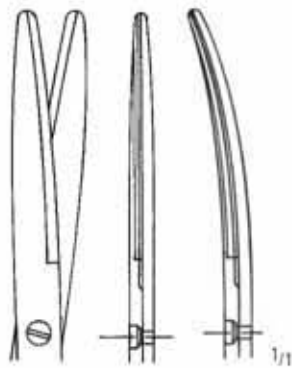

Original 18,0 cm

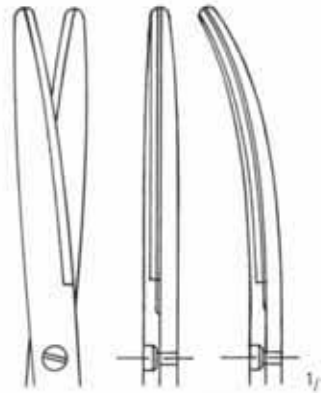

Original 20,0 cm



METZENBAUM

gerade
 straight
 rectas
 droits
 rette

gebogen
 curved
 curvas
 courbes
 curve

AC 940/18*	18,0 cm/7"	AC 941/18*
AC 940/20*	20,0 cm/8"	AC 941/20*

AA
 AB
 AC
 AD
 AE
 AF
 AG
 AH
 AI
 AJ
 AK
 AL
 AM
 AN
 AO
 AP
 AQ
 AR
 AS
 AT
 AU
 AV
 AW
 AX

AC SCHEREN SCISSORS TIJERAS CISEAUX FORBICI

Scheren mit Hartmetalleinlagen
 Scissors with Tungsten Carbide Inserts
 Tijeras con filos de carburo de tungsteno
 Ciseaux avec plaquettes en carbure de tungstène
 Forbici con taglio al carburo di tungsteno



LEXER
 AC 952/16
 16,0 cm/6¹/₄"



LEXER
 AC 953/16*
 16,0 cm/6¹/₄"



AC 960/14*
 14,5 cm/5³/₄"

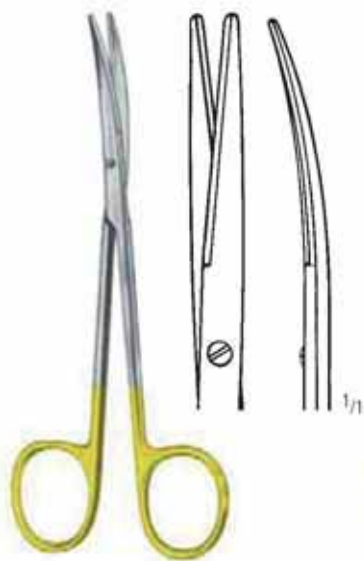

AC 961/14*
 14,5 cm/5³/₄"



AC 962/14
 14,5 cm/5³/₄"



AC 963/14
 14,5 cm/5³/₄"

METZENBAUM-DELICATE

SCHEREN SCISSORS TIJERAS CISEAUX FORBICI

Scheren mit Hartmetalleinlagen
 Scissors with Tungsten Carbide Inserts
 Tijeras con filos de carburo de tungsteno
 Ciseaux avec plaquettes en carbure de tungstène
 Forbici con taglio al carburo di tungsteno

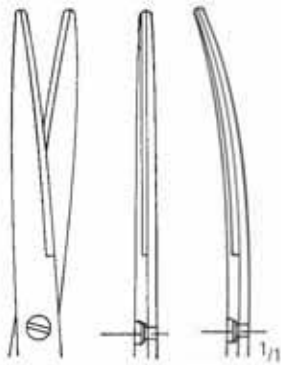

Original 18,0 cm



METZENBAUM-DELICATE

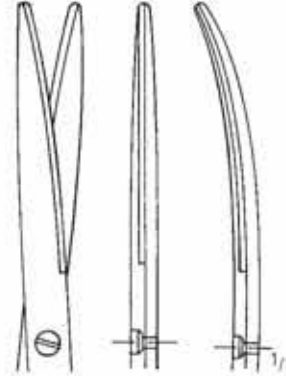

Original 20,0 cm



gerade
 straight
 rectas
 droits
 rette

gebogen
 curved
 curvas
 courbes
 curve

AC 970/18*	18,0 cm/7"	AC 971/18*
AC 970/20*	20,0 cm/8"	AC 971/20*

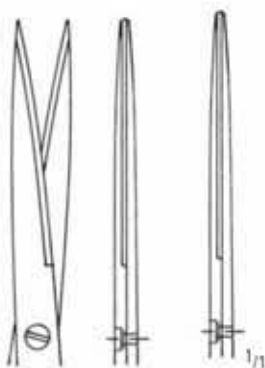

Original 18,0 cm



METZENBAUM-DELICATE

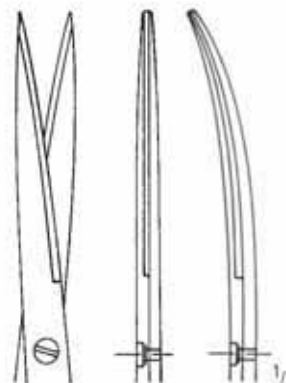

Original 20,0 cm



gerade
 straight
 rectas
 droits
 rette

gebogen
 curved
 curvas
 courbes
 curve

AC 972/18	18,0 cm/7"	AC 973/18
AC 972/20	20,0 cm/8"	AC 973/20

* Auch erhältlich als SC * Also available as SC

AA
 AB
AC
 AD
 AE
 AF
 AG
 AH
 AI
 AJ
 AK
 AL
 AM
 AN
 AO
 AP
 AQ
 AR
 AS
 AT
 AU
 AV
 AW
 AX

Scheren mit Hartmetalleinlagen
 Scissors with Tungsten Carbide Inserts
 Tijeras con filos de carburo de tungsteno
 Ciseaux avec plaquettes en carbure de tungstène
 Forbici con taglio al carburo di tungsteno



Original 11,5 cm

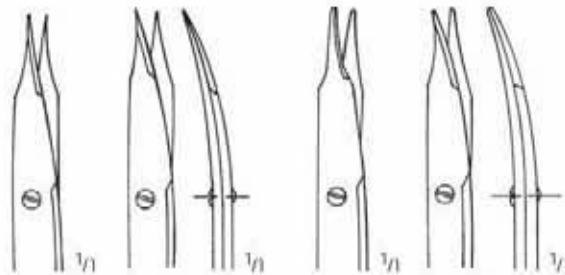

STEVENS

10,5 cm/4 1/4"
 11,5 cm/4 1/2"

	spitz pointed agudas pointues acuta		stumpf blunt romas mousses smussa
gerade straight rectas droits rette	gebogen curved curvas courbes curve	gerade straight rectas droits rette	gebogen curved curvas courbes curve

AC 974/10	AC 975/10	AC 976/10	AC 977/10
AC 974/11*	AC 975/11*	AC 976/11*	AC 977/11*

SCHEREN SCISSORS TIJERAS CISEAUX FORBICI

Scheren mit Hartmetalleinlagen
 Scissors with Tungsten Carbide Inserts
 Tijeras con filos de carburo de tungsteno
 Ciseaux avec plaquettes en carbure de tungstène
 Forbici con taglio al carburo di tungsteno

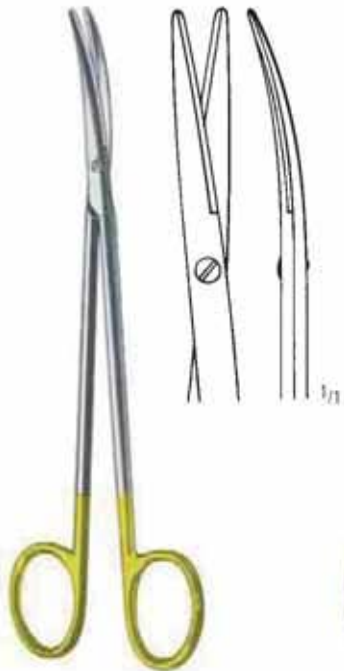

TOENNIS-ADSON-DELICATE
 AC 977/17
 17,5 cm/7"



GOLDMAN-FOX
 AC 980/13
 13,0 cm/5"



AC 981/13
 13,0 cm/5"

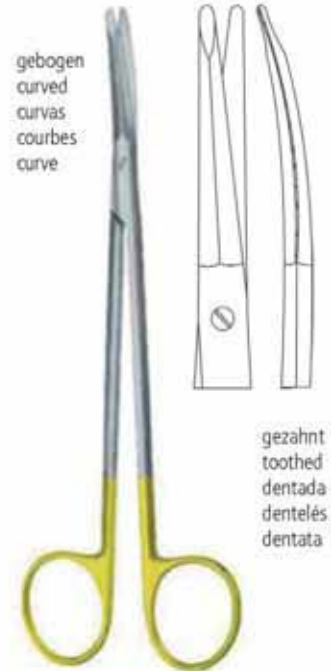

KAYE
 AC 983/15
 15,0 cm/6"

gebogen
 curved
 curvas
 courbes
 curve

gezahnt
 toothed
 dentada
 dentelés
 dentata



AC 984/11*
 11,5 cm/4 1/2"



AC 985/11*
 11,5 cm/4 1/2"



LISTER
 AC 999/18
 18,0 cm/7"

* Auch erhältlich als SC * Also available as SC

AA
 AB
 AC
 AD
 AE
 AF
 AG
 AH
 AI
 AJ
 AK
 AL
 AM
 AN
 AO
 AP
 AQ
 AR
 AS
 AT
 AU
 AV
 AW
 AX

SKALPELLE
SCALPELS
BISTURIES
BISTOURIS
BISTURI

AD

nopa[®] instruments

Weitere Skalpelle finden Sie in unserem Katalog „Allgemeines Instrumentarium“ in Gruppe AD.

For further scalpels kindly refer to our catalogue "General Instruments", section AD.

Para bisturios adicionales, por favor consulte nuestro catálogo de "Instrumental de uso general", grupo AD.

Pour des bistouris supplémentaires, consultez notre catalogue „Instrumentation Generale“, section AD.

Per gli altri bisturi, consultare il nostro catalogo "Strumentazione Generale", gruppo AD.





nopa[®] instruments



SKALPELLE SCALPELS BISTURIES BISTOURIS BISTURI

Skalpgriffe
 Scalpel Handles
 Mangos de bisturíes
 Manches pour bistouris
 Manici per bisturi

AA
 AB
 AC
 AD
 AE
 AF
 AK
 AL
 AO
 AP
 AR
 KA
 KL
 KM
 KO
 KU
 KYE
 X



AD 009/03
 No. 3



AD 010/03
 No. 3



AD 010/04
 No. 4



AD 010/05
 No. 5K

Skalpellgriffe
 Scalpel Handles
 Mangos de bisturíes
 Manches pour bistouris
 Manici per bisturi



AD 025/07
 No. 7



AD 027/07
 No. 7K



AD 030/16



COLLIN
 AD 040/08
 No. 8

hohl
 hollow
 hueco
 creux
 vuoto



COLLIN
 AD 042/09
 No. 9

Skalpellgriffe, Skalpellklingen
 Scalpel Handles, Scalpel Blades
 Mangos de bisturíes, Hojas de bisturíes
 Manches pour bistouris, Lames de bistouris
 Manici per bisturi, Lame per bisturi

MINI

Verpackungseinheit / packing unit = 10 St./pc.



Fig. 61
AD 065/61



Fig. 62
AD 065/62



Fig. 62S
AD 065/63



Fig. 64
AD 065/64



Fig. 65
AD 065/65



Fig. 67
AD 065/67



Fig. 69
AD 065/69

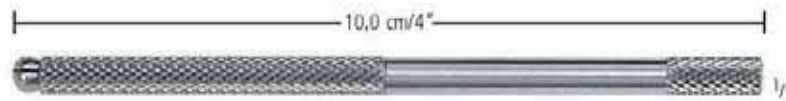

AD 065/10



AD 065/13



AD 065/15

AA
AB
AC
AD
AE
AF
AK
AL
AO
AP
AR
KA
KL
KM
KO
KU
KYE
X

AD SKALPELLE SCALPELS BISTURIES BISTOURIS BISTURI

Skalpellsklingen
Scalpel Blades
Hojas de bisturíes
Lames pour bistouris
Lame per bisturi

passend für die Griffe
for handles
para los mangos
pour les manches
per i manici

- AD 009/03
- AD 010/03
- AD 010/05
- AD 025/07
- AD 027/07
- AD 030/16
- AD 040/08



Fig.10
AD 075/10



Fig.11
AD 075/11



Fig.12d
AD 076/12



Fig.15
AD 075/15



Fig.15c
AD 076/15



passend für die Griffe
for handles
para los mangos
pour les manches
per i manici

- AD 010/04
- AD 042/09



Fig.20
AD 075/20



Fig.21
AD 075/21



Fig.22
AD 075/22



Fig.23
AD 075/23



Fig.24
AD 075/24

Dermatome
 Dermatomes
 Dermatomos
 Dermatomes
 Dermatomi

AA
 AB
 AC
 AD
 AE
 AF
 AG
 AH
 AI
 AJ
 AK
 AL
 AM
 AN
 AO
 AP
 AQ
 AR
 AS
 AT
 AU
 AV
 AW
 AX



AD 495/31
 15,5 cm/6"

WATSON
 AD 495/30
 30,5 cm/12"
 0,1 - 2,0 mm

HUMBY
 AD 495/32
 32,0 cm/12³/₄"
 0,1 - 1,2 mm

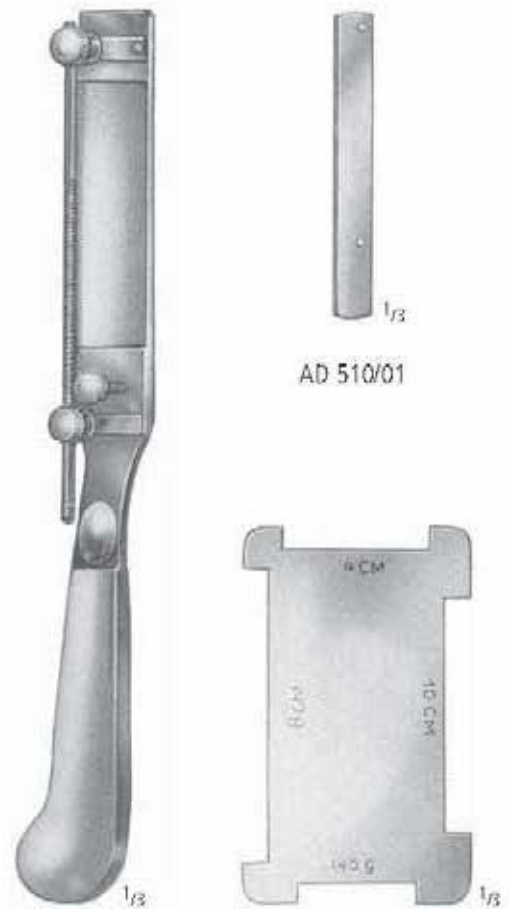

AD 510/01

AD 510/02

SCHINK
 AD 500/00
 30,0 cm/12"

Rasierklngen, Klingenbrecher
 Razor Blades, Blade Breakers
 Hojas de afeitaz, Pinzas para romper hojas
 Lames de rasoir, Pincettes pour casser les lames
 Lamette da barba, Pinze per rompere la lamette

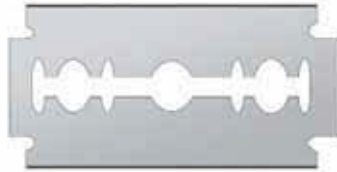

AD 540/00

RASIERKLINGEN, VERPACKUNGSEINHEIT 10 STCK
 RAZOR BLADES, PACKING UNIT 10 PIECES
 HOJAS DE AFEITAR, UNIDAD DE VENTA 10 PZ
 LAMES DE RASOIR, UNITÉ À 10 PIÈCES
 LAMETTE DA BARBA, UNITÀ DI VENDITA 10 PZ



1/11

TROUTMAN-CHRIS
 AD 550/09
 Ø 5,5 mm
 9,0 cm/3 1/2"



1/11

TROUTMAN-CHRIS
 AD 551/09
 Ø 5,5 mm
 9,0 cm/3 1/2"



1/11

AD 552/11
 11,0 cm/4 1/3"



1/11

CASTROVIEJO
 AD 554/13
 Ø 8 mm
 13,0 cm/5"

NAHT
SUTURE
SUTURA
SUTURE
SUTURA

AE

nopa[®] instruments

Weitere Naht-Instrumente finden Sie in unserem Katalog „Allgemeines Instrumentarium“ in Gruppe AE.

For further suture instruments kindly refer to our catalogue "General Instruments", section AE.

Para instrumentos de sutura adicionales, por favor consulte nuestro catálogo de "Instrumental de uso general", grupo AE.

Pour des instruments de suture supplémentaires, consultez notre catalogue „Instrumentation Generale“, section AE.

Per gli altri accessori di sutura, consultare il nostro catalogo "Strumentazione Generale", gruppo AE.



Nadelhalter
Needle Holders
Porta-agujas
Porte-aiguilles
Portaghi



BOYNTON
AE 036/12
12,0 cm/4³/₄"

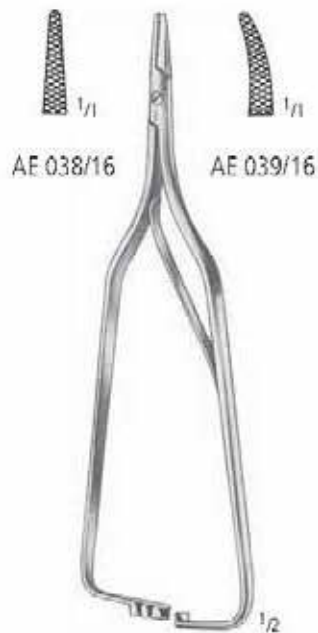

ARRUGA
16,0 cm/6¹/₄"



DERF
AE 050/12
12,0 cm/4³/₄"



DERF-CONVERSE
AE 052/12
12,5 cm/5"

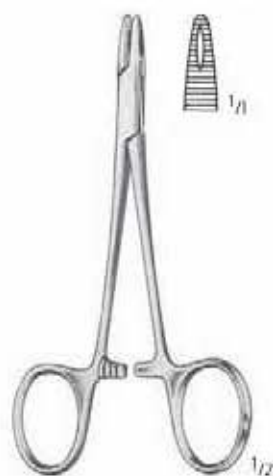

COLLIER
AE 056/12
12,5 cm/5"

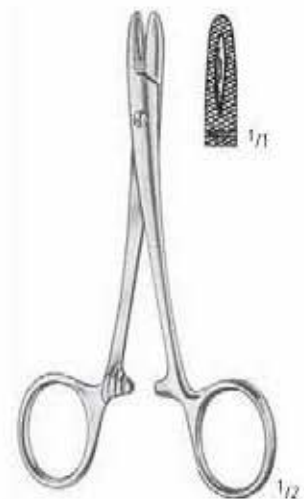

DOYEN
AE 058/12
12,5 cm/5"

NAHT SUTURE SUTURA SUTURE SUTURA

Nadelhalter
Needle Holders
Porta-agujas
Porte-aiguilles
Portaghi

AA
AB
AC
AD
AE
AF
AG
AH
AI
AJ
AK
AL
AM
AN
AO
AP
AQ
AR
AS
AT
AU
AV
AW
AX

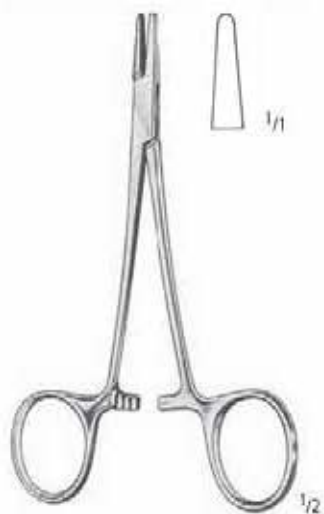

WEBSTER
AE 060/13
13,0cm/5"

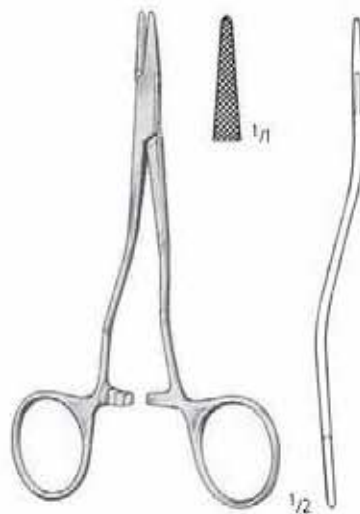

KILNER
AE 063/13
13,0 cm/5"

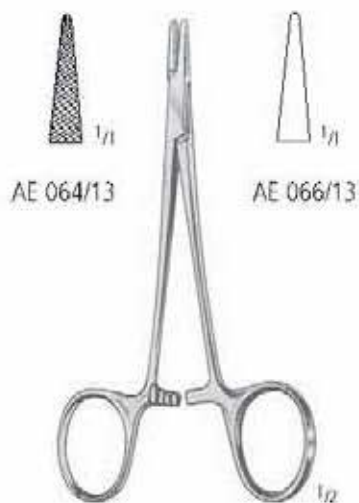

HALSEY
13,0cm/5"



NEIVERT
AE 068/13
13,0cm/5"

AE NAHT SUTURE SUTURA SUTURE SUTURA

Nadelhalter
Needle Holders
Porta-agujas
Porte-aiguilles
Portaghi



CRILE-WOOD
15,0 cm/6" AE 070/15
18,0 cm/7" AE 070/18



BABY-CRILE-WOOD
AE 072/15
15,0 cm/6"



CARROLL
AE 074/15
15,0 cm/6"



CRILE-MURRAY
AE 076/15
15,0 cm/6"



SAROT
AE 080/18
18,0 cm/7"

NAHT SUTURE SUTURA SUTURE SUTURA

Nadelhalter
Needle Holders
Porta-agujas
Porte-aiguilles
Portaghi

AA
AB
AC
AD
AE
AF
AK
AL
AO
AP
AR
KA
KL
KM
KO
KU
KYE
X

<p>AE 088/15 15,0 cm/6"</p>	<p>AE 088/17 17,0 cm/6³/₄"</p>	<p>AE 090/17 17,0 cm/6³/₄"</p>		<p>ADSON AE 094/18 18,0 cm/7"</p>	
<p>SENNING (Schwed. Modell)</p>		<p>M.G.H. (Mass.-General-Hospital)</p>			

	<p>AE 100/14 14,0 cm/5¹/₂"</p>	<p>AE 100/16 16,0 cm/6¹/₄"</p>	<p>AE 100/18 18,0 cm/7"</p>	<p>AE 100/20 20,0 cm/8"</p>	
	<p>MAYO-HEGAR-DELICATE</p>				
<p>MAYO-HEGAR</p>	<p>AE 110/16 16,0 cm/6¹/₄"</p>	<p>AE 110/18 18,0 cm/7"</p>	<p>AE 110/20 20,0 cm/8"</p>		<p>BAUMGARTNER AE 112/14 14,0 cm/5¹/₂"</p>

AE NAHT SUTURE SUTURA SUTURE SUTURA

Nadelhalter
Needle Holders
Porta-agujas
Porte-aiguilles
Portaghi

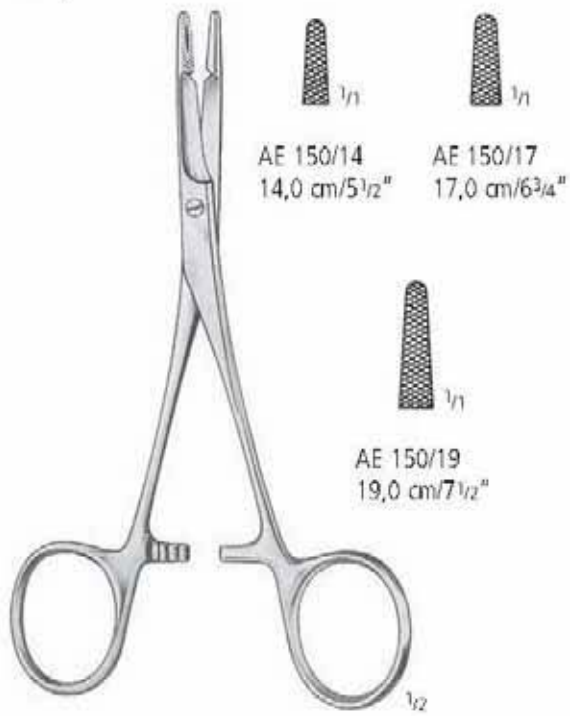

OLSEN-HEGAR

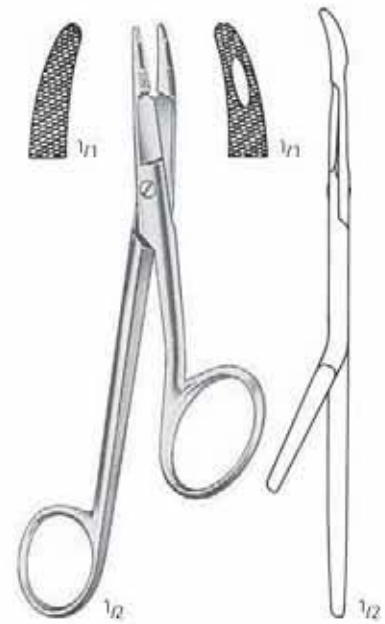

GILLIES
AE 155/16
16,0 cm/6 1/4"

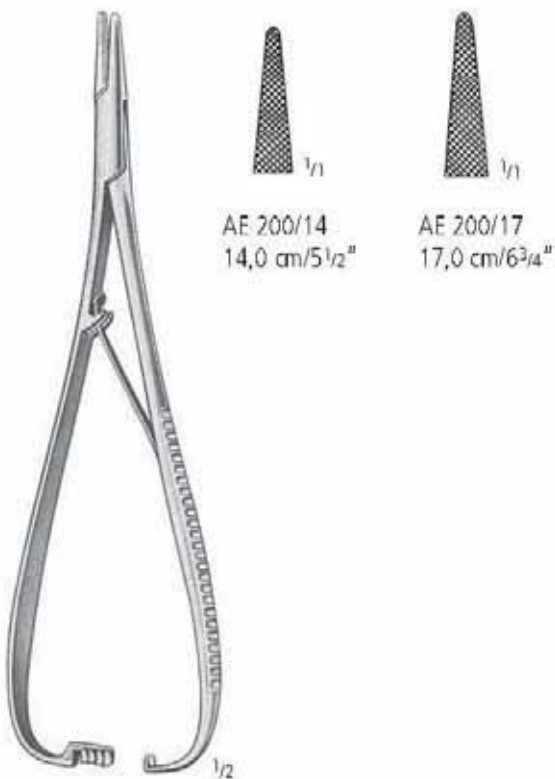

MATHIEU

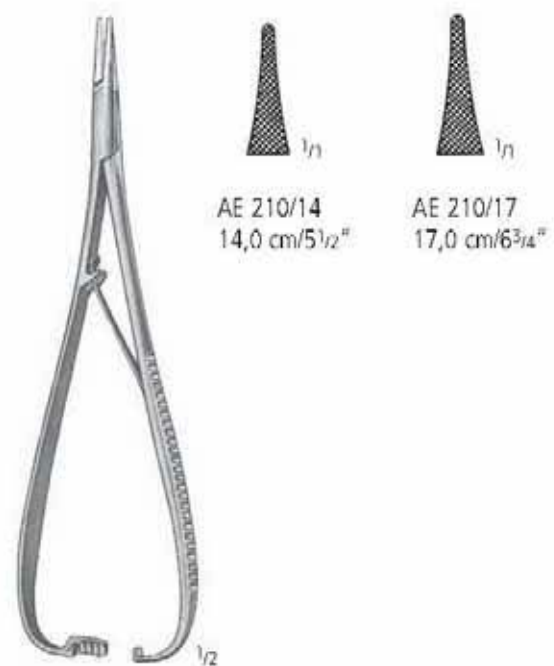

MATHIEU-DELICATE

NAHT SUTURE SUTURA SUTURE SUTURA

Nadelhalter
Needle Holders
Porta-agujas
Porte-aiguilles
Portaghi



EISELSBERG-MATHIEU
AE 219/18
18,5 cm/7¹/₃"



CRILE
AE 224/15
15,0 cm/6"



TOENNIS
AE 226/18
18,0 cm/7"



LANGENBECK



AE 228/16
16,0 cm/6¹/₄"



AE 228/18
18,0 cm/7"



AE 228/20
20,0 cm/8"





AA
AB
AC
AD
AE
AF
AK
AL
AO
AP
AR
KA
KL
KM
KO
KU
KYE
X

AE NAHT SUTURE SUTURA SUTURE SUTURA

Nadelhalter mit Hartmetalleinsätzen
 Needle Holders with Tungsten Carbide Inserts
 Porta-agujas con bocas de carburo de Tungsteno
 Porte-aiguilles à mors en carbure de tungstène
 Portaghi con placche di carburo di tungsteno





MAYO-HEGAR

- 
AE 400/14
14,0 cm/5 1/2"
- 
AE 400/16
16,0 cm/6 1/4"
- 
AE 400/18
18,0 cm/7"
- 
AE 400/20
20,0 cm/8"



**DE BAKEY
 (MAYO-HEGAR-DELICATE)**

- 
AE 420/18
18,0 cm/7"
- 
AE 420/20
20,0 cm/8"



RYDER/FRENCH-EYE

- 
AE 430/13
13,0 cm/5"
- 
AE 430/15
15,0 cm/6"
- 
AE 430/18
18,0 cm/7"

MICRO RYDER

- 
AE 434/13
13,0 cm/5"
- 
AE 434/15
15,0 cm/6"
- 
AE 434/18
18,0 cm/7"

NAHT SUTURE SUTURA SUTURE SUTURA

Nadelhalter mit Hartmetalleinsätzen
 Needle Holders with Tungsten Carbide Inserts
 Porta-agujas con bocas de carburo de Tungsteno
 Porte-aiguilles à mors en carbure de tungstène
 Portaghi con placche di carburo di tungsteno

AA
AB
AC
AD
AE
AF
AK
AL
AO
AP
AR
KA
KL
KM
KO
KU
KYE
X

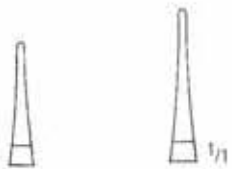

AE 436/14 14,0 cm/5 1/2"
 AE 436/18 18,0 cm/7"

EUFRATE PASQUÉ

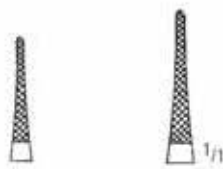

AE 438/14 14,0 cm/5 1/2"
 AE 438/18 18,0 cm/7"

MICROVASCULAR



extrem fein extremely delicate muy fino très fin molto fino



CARROLL
 AE 440/15
 15,0 cm/6"

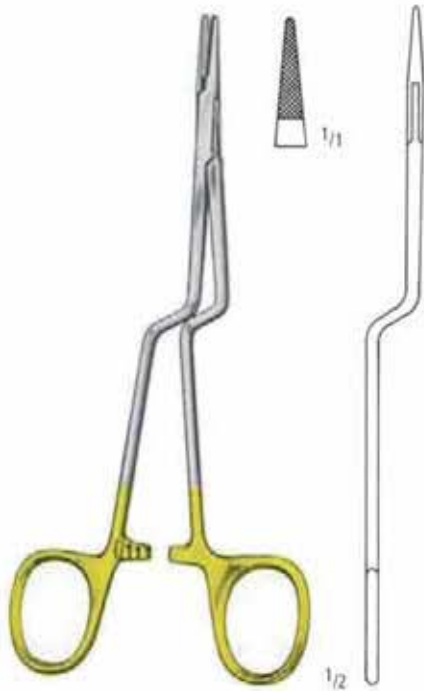

JACOBSON
 AE 444/18
 18,0 cm/7"



NEW ORLEANS
 AE 446/18
 18,0 cm/7"

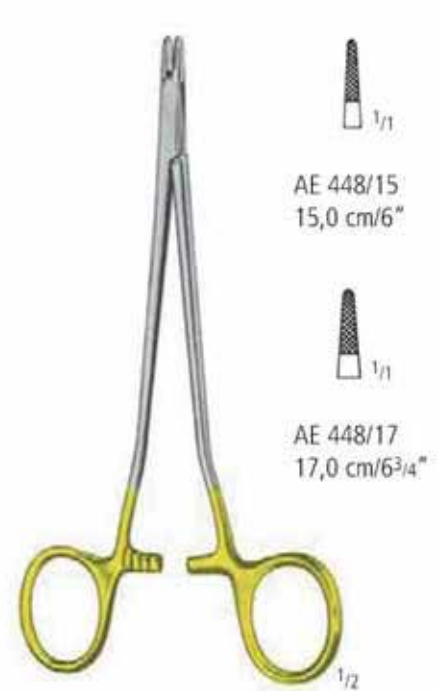

SENNING
 (SWEDISH PATTERN)

AE 448/15
 15,0 cm/6"

AE 448/17
 17,0 cm/6 3/4"

AE NAHT SUTURE SUTURA SUTURE SUTURA

Nadelhalter mit Hartmetalleinsätzen
 Needle Holders with Tungsten Carbide Inserts
 Porta-agujas con bocas de carburo de Tungsteno
 Porte-aiguilles à mors en carbure de tungstène
 Portaghi con placche di carburo di tungsteno



DERF
 AE 450/12
 12,5 cm/5"



CONVERSE
 AE 452/12
 12,5 cm/5"

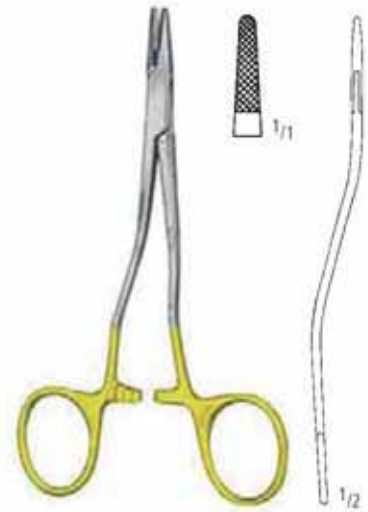

KILNER
 AE 455/13
 13,5 cm/5 1/4"



NEIVERT
 AE 456/13
 13,0 cm/5"



WEBSTER
 AE 460/13
 13,0 cm/5"



HALSEY
 13,0 cm/5"

NAHT SUTURE SUTURA SUTURE SUTURA

Nadelhalter mit Hartmetalleinsätzen
 Needle Holders with Tungsten Carbide Inserts
 Porta-agujas con bocas de carburo de Tungsteno
 Porte-aiguilles à mors en carbure de tungstène
 Portaghi con placche di carburo di tungsteno



BABY-CRILE-WOOD
 AE 468/15
 15,0 cm/6"



CRILE-WOOD
 AE 469/15
 15,0 cm/6"



CRILE-WOOD
 AE 470/15
 15,0 cm/6"



CRILE-WOOD

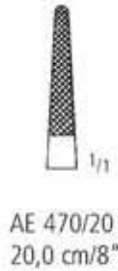
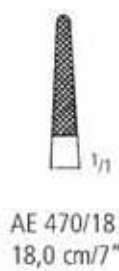

SAROT

AE 480/18
 18,0 cm/7"

AA
 AB
 AC
 AD
AE
 AF
 AK
 AL
 AO
 AP
 AR
 KA
 KL
 KM
 KO
 KU
 KYE
 X

Nadelhalter
 Needle Holders
 Porta-agujas
 Porte-aiguilles
 Portaghi

nopa® DIAMOND



15,0 cm/6"
 18,0 cm/7"

KS 084/15
 KS 084/18

NAHT SUTURE SUTURA SUTURE SUTURA

Nadelhalter mit Hartmetalleinsätzen
 Needle Holders with Tungsten Carbide Inserts
 Porta-agujas con bocas de carburo de Tungsteno
 Porte-aiguilles à mors en carbure de tungstène
 Portaghi con placche di carburo di tungsteno



OLSEN-HEGAR



AE 488/14
 14,0 cm/5 1/2"



AE 488/17
 17,0 cm/6 3/4"



AE 488/19
 19,0 cm/7 1/2"



GILLIES
 AE 490/16
 16,0 cm/6 1/4"



MATHIEU



AE 500/14
 14,0 cm/5 1/2"



AE 500/17
 17,0 cm/6 3/4"



MATHIEU



AE 501/14
 14,0 cm/5 1/2"

AA
 AB
 AC
 AD
AE
 AF
 AK
 AL
 AO
 AP
 AR
 KA
 KL
 KM
 KO
 KU
 KYE
 X

AE NAHT SUTURE SUTURA SUTURE SUTURA

Nadelhalter mit Hartmetalleinsätzen
 Needle Holders with Tungsten Carbide Inserts
 Porta-agujas con bocas de carburo de Tungsteno
 Porte-aiguilles à mors en carbure de tungstène
 Portaghi con placche di carburo di tungsteno



AE 504/14
14,0 cm/5 1/2"



AE 504/17
17,0 cm/6 3/4"



AE 504/20
20,0 cm/8"



AE 507/17
17,0 cm/6 3/4"



AE 507/19
19,5 cm/7 1/2"

METZENBAUM



AE 510/17
17,0 cm/6 3/4"

MATHIEU-RYDER



AE 512/17
17,0 cm/6 3/4"

MATHIEU-RYDER VASCULAR

NAHT SUTURE SUTURA SUTURE SUTURA

Nadelhalter mit Hartmetalleinsätzen
 Needle Holders with Tungsten Carbide Inserts
 Porta-agujas con bocas de carburo de Tungsteno
 Porte-aiguilles à mors en carbure de tungstène
 Portaghi con placche di carburo di tungsteno



AE 514/12



AE 515/12



AE 516/16



AE 517/16

BOYNTON
12,0 cm/4³/₄"



ARRUGA
16,0 cm/6¹/₄"



TOENNIS
AE 522/18
18,0 cm/7"



LICHTENBERG
AE 524/20
20,0 cm/8"



EISELSBERG-MATHIEU
AE 533/18
18,5 cm/7¹/₃"

AA
AB
AC
AD
AE
AF
AK
AL
AO
AP
AR
KA
KL
KM
KO
KU
KYE
X

AE NAHT SUTURE SUTURA SUTURE SUTURA

Nadelhalter, Drahtzangen mit Hartmetalleinsätzen
 Needle Holders, Wire Twisting Forceps with Tungsten Carbide Inserts
 Porta-agujas, Pinzas para torcer hilos con bocas de carburo de Tungsteno
 Porte-aiguilles, Pincas à torsader le fil à mors en carbure de tungstène
 Portaghi, Pinze per ritorcere fili con placche di carburo di tungsteno



AE 542/18
18,0 cm/7"

LANGENBECK-DELICATE



AE 544/18
18,0 cm/7"



AE 544/20
20,0 cm/8"

LANGENBECK-RYDER

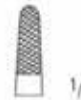

AE 550/13
13,0 cm/5"



AE 550/18
18,0 cm/7"

STERNUM



AE 551/01
15,0 cm/6"



AE 551/02
18,0 cm/7"



AE 556/01
16,5 cm/6 1/2"



AE 556/02
15,0 cm/6"



AE 556/03
15,0 cm/6"

CORWIN

NAHT SUTURE SUTURA SUTURE SUTURA

Mikro-Nadelhalter mit Hartmetalleinsätzen
 Micro-Needle Holders with Tungsten Carbide Inserts
 Micro-Porta-agujas con bocas de carburo de Tungsteno
 Micro-Porte-aiguilles à mors en carbure de tungstène
 Micro-Portaghi con placche di carburo di tungsteno

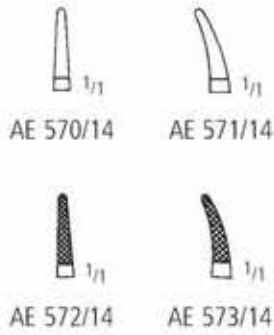

CASTROVIEJO
 14,0 cm/5 1/2"

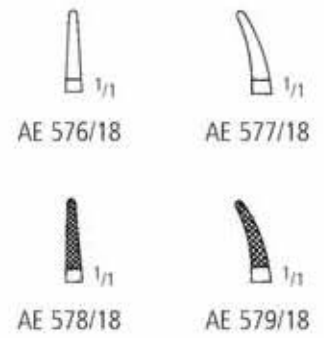

18,0 cm/7"

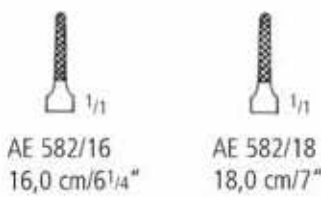

DIETRICH



KALT
 AE 584/14
 13,5 cm/5 1/4"



CASTROVIEJO
 AE 586/13
 13,0 cm/5"

AA
 AB
 AC
 AD
AE
 AF
 AK
 AL
 AO
 AP
 AR
 KA
 KL
 KM
 KO
 KU
 KYE
 X

Nadelhalter
Needle Holders
Porta-agujas
Porte-aiguilles
Portaghi

nopa[®] DIAMOND



14,0 cm/5 1/2"

KS 080/14



1/1



1/1

18,0 cm/7"

KS 080/18



14,0 cm/5 1/2"

KS 081/14



1/1



1/1

18,0 cm/7"

KS 081/18

Nadelhalter
 Needle Holders
 Porta-agujas
 Porte-aiguilles
 Portaghi

nopa[®] DIAMOND



1/1
 21,0 cm/8 1/4"



KS 082/21



KS 083/21

- AA
- AB
- AC
- AD
- AE**
- AF
- AK
- AL
- AO
- AP
- AR
- KA
- KL
- KM
- KO
- KU
- KYE
- X

Mikro-Nadelhalter mit Rundgriff
 Micro-Needle Holders with Pen-Type Handle
 Micro-Porta-agujas con mango redondo
 Micro-Porte-aiguilles à manches rondes
 Micro-Portaghi con manici rotondi



REILL
 15,0 cm/6"



REILL
 15,0 cm/6"

NAHT SUTURE SUTURA SUTURE SUTURA

Mikro-Nadelhalter mit Rundgriff
 Micro-Needle Holders with Pen-Type Handle
 Micro-Porta-agujas con mango redondo
 Micro-Porte-aiguilles à manches rondes
 Micro-Portaghi con manici rotondi



AE 621/14
 14,0 cm/5 1/2"



AE 623/14
 14,0 cm/5 1/2"

...für Rechtshänder
 ...for right handed surgeons
 ...para diestros
 ...pour des droitiers
 ...per destrimanì

Maulteil konkav/konvex
 Jaws concave/convex
 Bocas concavas/convexas
 Mors concave/convexe
 Morso concavo/convesso



AE 625/14
 14,0 cm/5 1/2"

...für Linkshänder
 ...for left handed surgeons
 ...para zurdos
 ...pour gaucher
 ...per mancini

AA
 AB
 AC
 AD
 AE
 AF
 AK
 AL
 AO
 AP
 AR
 KA
 KL
 KM
 KO
 KU
 KYE
 X

AE NAHT SUTURE SUTURA SUTURE SUTURA

Mikro-Nadelhalter mit Rundgriff
 Micro-Needle Holders with Pen-Type Handle
 Micro-Porta-agujas con mango redondo
 Micro-Porte-aiguilles à manches ronds
 Micro-Portaghi con manici rotondi



AE 630/18
 18,0 cm/7"



AE 631/18
 18,0 cm/7"



AE 632/18
 18,0 cm/7"



AE 633/18
 18,0 cm/7"

NAHT SUTURE SUTURA SUTURE SUTURA

Mikro-Nadelhalter
 Micro-Needle Holders
 Micro-Porta-agujas
 Micro-Porte-aiguilles
 Micro-Portaghi

AA

AB

AC

AD

AE

AF

AK

AL

AO

AP

AR

KA

KL

KM

KO

KU

KYE

X



AE 680/16
 AE 680/18

16,5 cm/6 1/2"
 18,0 cm/7"



AE 681/16
 AE 681/18

AE NAHT SUTURE SUTURA SUTURE SUTURA

Reverdin-Nadeln, Unterbindungsnadeln
 Reverdin Needles, Ligature Needles
 Agujas de Reverdin, Agujas para ligaduras
 Aiguilles de Reverdin, Aiguilles à ligatures
 Aghi di Reverdin, Aghi per legatura



1/2

REVERDIN
 14,0 cm/5 1/2"



1/1

Fig. 1
 AE 700/01



1/1

2
 AE 700/02



1/1

3
 AE 700/03



1/1

4
 AE 700/04

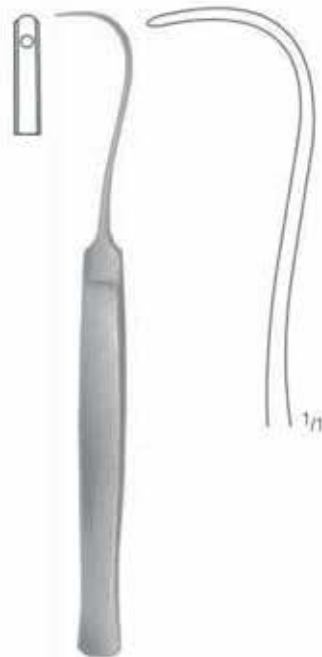

1/1

SYME
 AE 753/17
 17,0 cm/6 3/4"

NAHT SUTURE SUTURA SUTURE SUTURA

Unterbindungsnaedeln
Ligature Needles
Agujas para ligaduras
Aiguilles à ligatures
Aghi per legatura

AA
AB
AC
AD
AE
AF
AK
AL
AO
AP
AR
KA
KL
KM
KO
KU
KYE
X



DE LA ROZA
AE 767/01
12,0 cm/4³/₄"

DE LA ROZA
AE 767/02
12,0 cm/4³/₄"



HESSBERG
AE 768/15
15,0 cm/6"



JACOBI
AE 769/14
14,0 cm/5¹/₂"



KRONECKER
AE 770/01
15,0 cm/6"



KRONECKER
AE 770/02
15,0 cm/6"

Wundklammerzängchen
Suture forceps
Pinzas para agrafes
Pincès pour agrafes
Pinze per agrafes



MICHEL
AE 850/12
12,0 cm/4³/₄"



COLLIN
AE 852/13
13,0 cm/5"



RICHTER-HEATH
AE 853/14
14,0 cm/5¹/₂"



WACHENFELDT
AE 855/01
12,5 cm/5"



HEGENBARTH
AE 856/12
12,5 cm/5"



MICHEL
AE 858/12
12,0 cm/4³/₄"

NAHT SUTURE SUTURA SUTURE SUTURA

Wundklammerzangen, -pinzetten und Wundklammern
 Suture forceps and Clips
 Pinzas para agrafes y agrafes
 Pincas pour agrafes et agrafes
 Pinze per agrafes ed agrafes



LANGE
 AE 859/10
 10,0 cm/4"



CHILDE
 AE 860/01
 18,0 cm/7"



CHILDE
 AE 860/02
 18,0 cm/7"

Verkaufseinheit: 1000 Stück
 Unit for Sale: 1000 each
 Unidad de venta: 1000 piezas
 Unité de vente: 1000 pièces
 Unità di vendita: 1000 pezzi



MICHEL

Größen
 sizes
 tamaños
 dimensions
 dimensioni

Artikel Nr.	mm	
AE 870/08	7,5 x 1,75	
AE 870/11	11 x 2,5	
AE 870/12	12 x 3	
AE 870/14	14 x 3	
AE 870/16	16 x 3	
AE 870/18	18 x 3	
AE 870/20	20 x 3	
AE 870/22	22 x 3	

AA
 AB
 AC
 AD
AE
 AF
 AK
 AL
 AO
 AP
 AR
 KA
 KL
 KM
 KO
 KU
 KYE
 X

Weitere Instrumente der Bereiche AF-AR finden Sie in unserem Katalog „Allgemeines Instrumentarium“ in den Gruppen AF-AR.

For further instruments of the section AF-AR kindly refer to our catalogue "General Instruments", sections AF-AR.

Para instrumentos adicionales del este grupo AF-AR, por favor consulte nuestro catálogo de "Instrumental de uso general", grupos AF-AR.

Pour instruments supplémentaires AF-AR, consultez notre catalogue „Instrumentation Generale“, sections AF-AR.

Per altri strumenti de questo gruppo AF-AR, consultare il nostro catalogo "Strumentazione Generale", gruppi AF-AR.

AF-AR

nopa[®] instruments

Tupferzangen	Seite	176-180
Sponge Forceps	Page	176-180
Pinzas para pólipos	Página	176-180
Pinces à pansements	Page	176-180
Pinze per polipi	Pagina	176-180
Wundhaken	Seite	181-198
Retractors	Page	181-198
Separadores	Página	181-198
Ecarteurs	Page	181-198
Divaricatori	Pagina	181-198
Sonden	Seite	199-202
Probes	Page	199-202
Sondas	Página	199-202
Sondes	Page	199-202
Sonde	Pagina	199-202
Punktion/Kanülen	Seite	203-214
Puncture/Special Needles	Page	203-214
Punción/Agujas especiales	Página	203-214
Ponction/Aiguilles spéciales	Page	203-214
Puntura/Aghi speciali	Pagina	203-214
Narkose	Seite	215-226
Anaesthesia	Page	215-226
Anestesia	Página	215-226
Anesthésie	Page	215-226
Anestesia	Pagina	215-226
Diagnostik	Seite	227-236
Diagnostics	Page	227-236
Diagnóstico	Página	227-236
Diagnostico	Page	227-236
Diagnostica	Pagina	227-236



Schwammzangen
Sponge Holding Forceps
Pinzas para esponjas
Pincas à éponges
Pinze per spugne



BRYANT
AF 040/13
13,0 cm/5"



LISTER
13,0 cm/5" AF 050/13
16,0 cm/6 1/4" AF 050/16
18,0 cm/7" AF 050/18

Korn- und Tupferzangen, Schwammzangen
 Polypus and Dressing Forceps, Sponge Holding Forceps
 Pinzas para pólipos, tapones y esponjas
 Pincas à pansements, à tampons et à éponges
 Pinze per polipi, tamponi e spugne

AA
 AB
 AC
 AD
 AE
 AF
 AK
 AL
 AO
 AP
 AR
 KA
 KL
 KM
 KO
 KU
 KYE
 X



GROSS-MAIER
 AF 100/20
 AF 100/25

20,0 cm/8"
 25,0 cm/10"



GROSS-MAIER
 AF 101/20
 AF 101/25

Korn- und Tupferzangen, Schwammzangen
 Polypus and Dressing Forceps, Sponge Holding Forceps
 Pinzas para pólipos, tapones y esponjas
 Pincés à pansements, à tampons et à éponges
 Pinze per polipi, tamponi e spugne



GROSS-MAIER
 AF 102/20
 AF 102/25

20,0 cm/8"
 25,0 cm/10"



GROSS-MAIER
 AF 103/20
 AF 103/25

TUPFERZANGEN SPONGE FORCEPS PINZAS PARA POLIPOS PINCES A PANSEMENTS PINZE PER POLIPI

Korn- und Tupferzangen, Schwammzangen
 Polypus and Dressing Forceps, Sponge Holding Forceps
 Pinzas para pólipos, tapones y esponjas
 Pincas à pansements, à tampons et à éponges
 Pinze per polipi, tamponi e spugne



DUPLAY
 AF 176/20
 20,5 cm/8"



DUPLAY
 AF 177/20
 20,5 cm/8"



FOERSTER-BALLENGER



AF 200/18
 AF 200/20

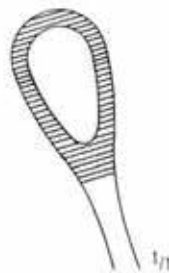

AF 201/18
 AF 201/20

18,0 cm/7"
 20,0 cm/8"



AF 202/18
 AF 202/20



AF 203/18
 AF 203/20

AA
 AB
 AC
 AD
 AE
AF
 AK
 AL
 AO
 AP
 AR
 KA
 KL
 KM
 KO
 KU
 KYE
 X

Korn- und Tupferzangen, Schwammzangen
 Polypus and Dressing Forceps, Sponge Holding Forceps
 Pinzas para pólipos, tapones y esponjas
 Pincés à pansements, à tampons et à éponges
 Pinze per polipi, tamponi e spugne



FOERSTER-BALLENGER
 25,0 cm/10"



AF 200/25



AF 201/25



AF 202/25



AF 203/25

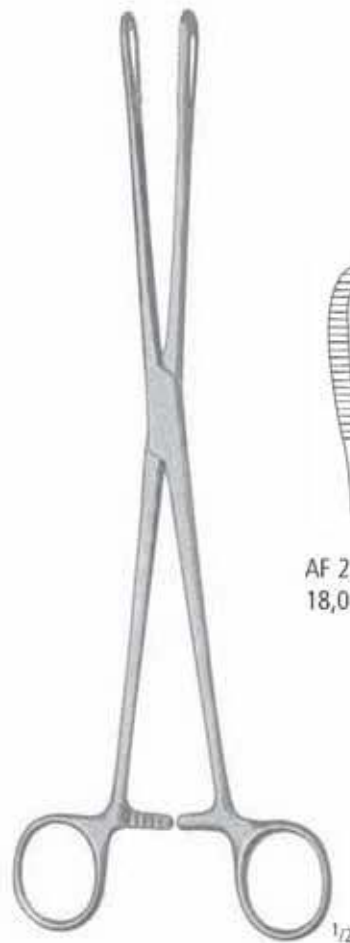

RAMPLEY

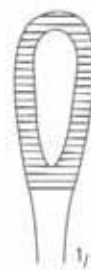

AF 216/18
 18,0 cm/7"

WUNDHAKEN RETRACTORS SEPARADORES ECARTEURS DIVARICATORI

Feine Wundhaken
Delicate Hooks
Ganchos
Crochets très fins
Divaricatori sottili

AA
AB
AC
AD
AE
AF
AK
AL
AO
AP
AR
KA
KL
KM
KO
KU
KYE
X



GILLIES
AK 020/01
18,0 cm/7"



GILLIES
AK 020/02
18,0 cm/7"



KILNER
AK 022/15
15,0 cm/6"



FRAZIER
AK 024/13
13,0 cm/5"



AK 026/01



KLEINERT-KUTZ
AK 026/02
16,0 cm/6 1/4"



AK 026/03

AK WUNDHAKEN RETRACTORS SEPARADORES ECARTEURS DIVARICATORI

Feine Wundhaken
 Delicate Hooks
 Ganchos
 Crochets très fins
 Divaricatori sottili

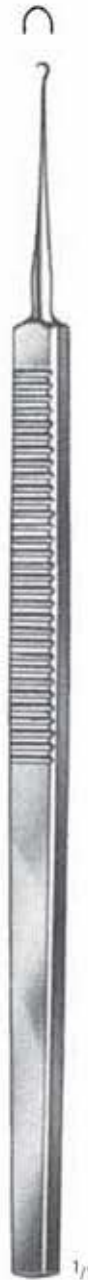

AK 028/01
 16,0 cm/6 1/4"

AK 028/02
 16,0 cm/6 1/4"

AK 028/03
 16,0 cm/6 1/4"

AK 028/04
 16,0 cm/6 1/4"

O'CONNOR
 AK 030/16
 16,0 cm/6 1/4"

GRAEFE
 AK 032/01
 16,0 cm/6 1/4"

GRAEFE
 AK 032/02
 16,0 cm/6 1/4"

WUNDHAKEN RETRACTORS SEPARADORES ECARTEURS DIVARICATORI

Felne Wundhaken
Delicate Hooks
Ganchos
Crochets très fins
Divaricatori sottili

AA
AB
AC
AD
AE
AF
AK
AL
AO
AP
AR
KA
KL
KM
KO
KU
KYE
X



CUSHING
28,0 cm/11"



AK 034/01



AK 034/02



CUSHING
19,0 cm/7 1/2"



AK 036/01



AK 036/02

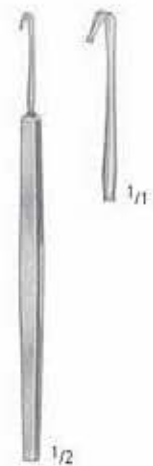

MOLDESTAD
AK 038/13
13,0 cm/5"



17,0 cm/6 3/4"



AK 040/05
5 mm



AK 040/07
7 mm



18,5 cm/7 1/3"



AK 042/10
Ø 1,0 mm



AK 042/12
Ø 1,2 mm



AK 044/11
11,0 cm/4 1/3"

AK WUNDHAKEN RETRACTORS SEPARADORES ECARTEURS DIVARICATORI

Feine Wundhaken
Delicate Hooks
Ganchos
Crochets très fins
Divaricatori sottili

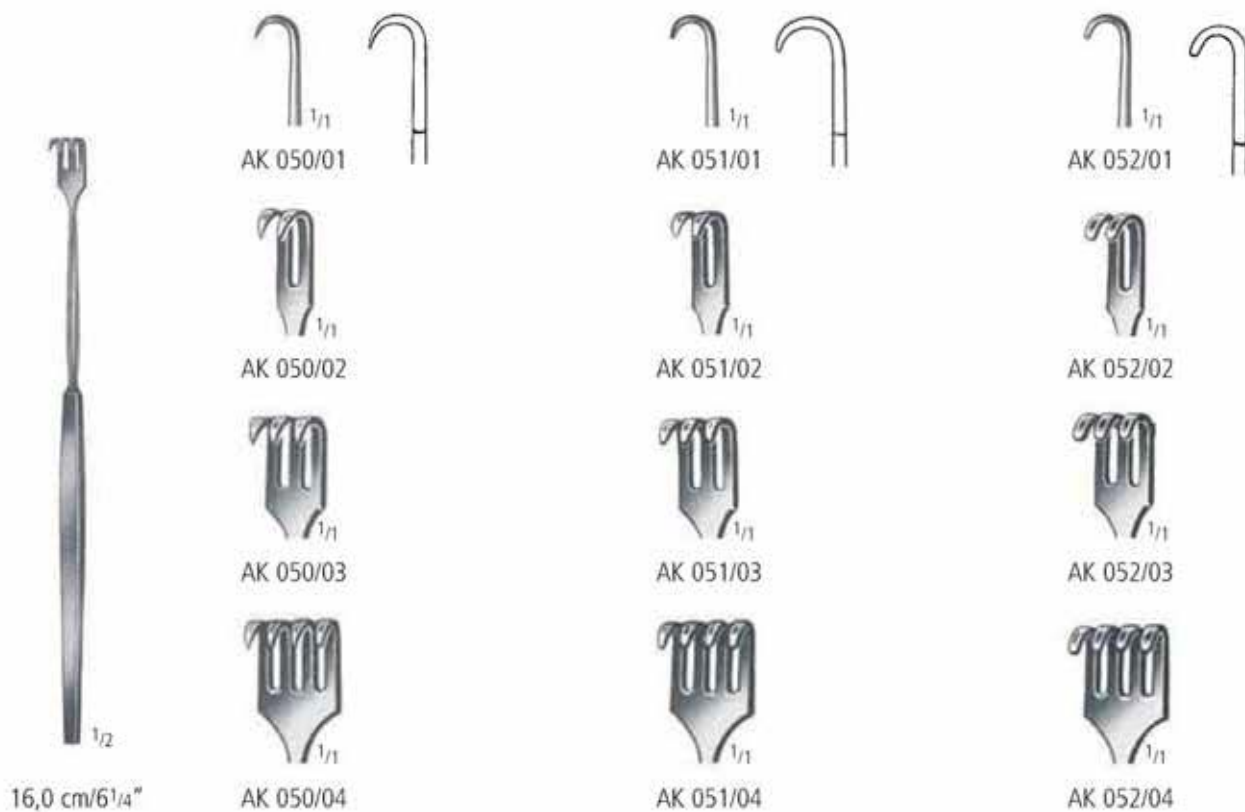

WUNDHAKEN RETRACTORS SEPARADORES ECARTEURS DIVARICATORI

Feine Wundhaken
Delicate Hooks
Ganchos
Crochets très fins
Divaricatori sottili

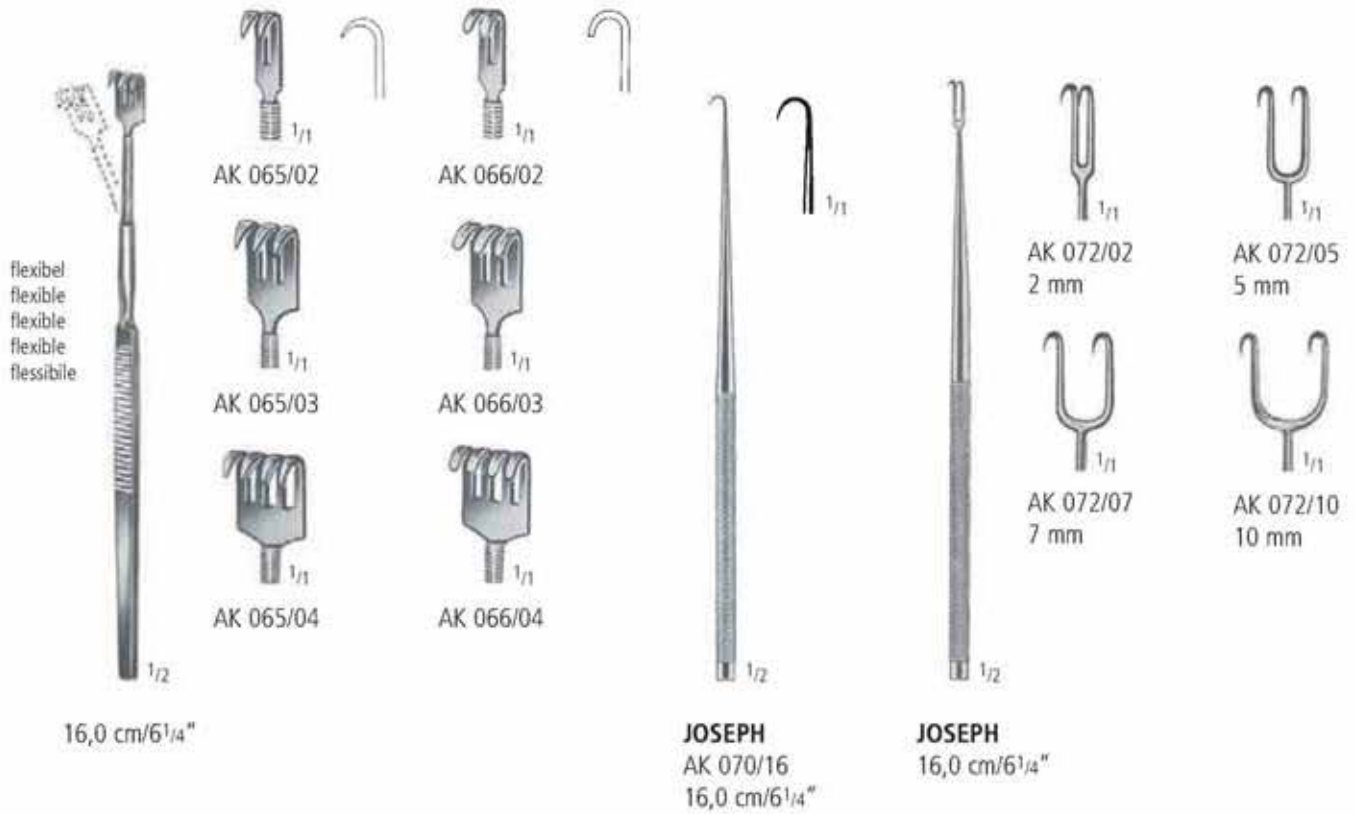

AA
AB
AC
AD
AE
AF
AK
AL
AO
AP
AR
KA
KL
KM
KO
KU
KYE
X

Feine Wundhaken
Delicate Hooks
Ganchos
Crochets très fins
Divaricatori sottili



MEYERDING
18,0 cm/7"



AK 080/01
18 x 7 mm



AK 080/02
16 x 5 mm



AK 080/03
7 x 4 mm



AK 080/04
10 x 3 mm



AK 080/05
7 x 4 mm



AK 080/06
4 x 10 mm



SENN-GREEN
15,0 cm/6"



AK 082/10
10 x 6 mm



AK 082/20
22 x 8 mm



MINI-LANGENBECK
16,0 cm/6 1/4"



AK 086/10
10 x 6 mm



AK 086/17
17 x 5 mm



AK 086/20
20 x 6 mm



AK 086/22
22 x 8 mm

WUNDHAKEN RETRACTORS SEPARADORES ECARTEURS DIVARICATORI

Feine Wundhaken
Delicate Hooks
Ganchos
Crochets très fins
Divaricatori sottili



DES MARRES
13,0 cm/5"

DES MARRES
16,0 cm/6 1/4"

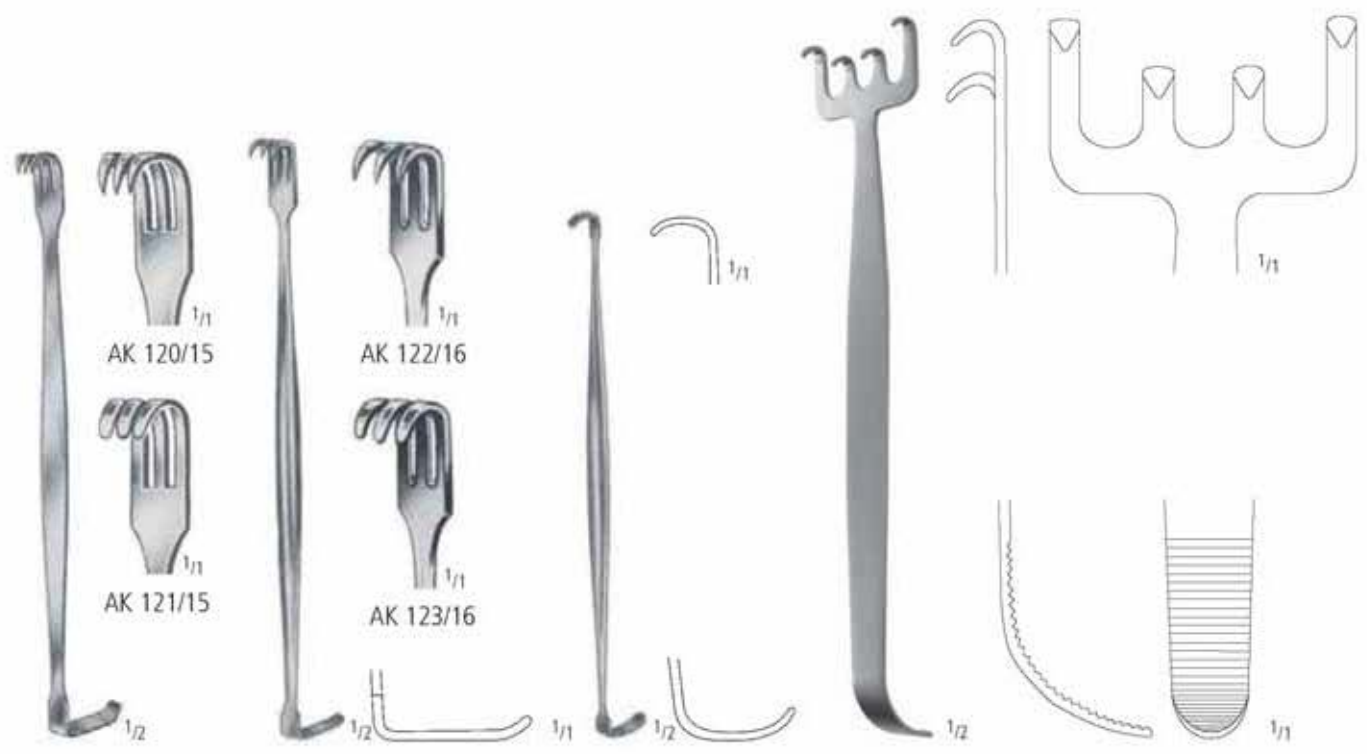

BABY-SENN-MILLER
15,0 cm/6"

SENN-MILLER
16,0 cm/6 1/4"

RAGNELL-DAVIS
AK 125/14
14,0 cm/5 1/2"

WALTER
AK 128/19
19,0 cm/7 1/2"

AA
AB
AC
AD
AE
AF
AK
AL
AO
AP
AR
KA
KL
KM
KO
KU
KYE
X



VOLKMANN
21,5 cm/8¹/₂"



KOCHER
22,0 cm/8³/₄"





KOCHER-LANGENBECK
21,5 cm/8¹/₂"



AK 233/01
25 x 6 mm



AK 233/02
35 x 8 mm



AK 233/03
35 x 11 mm



AK 233/04
35 x 15 mm



AK 233/05
40 x 11 mm



AK 233/06
55 x 11 mm

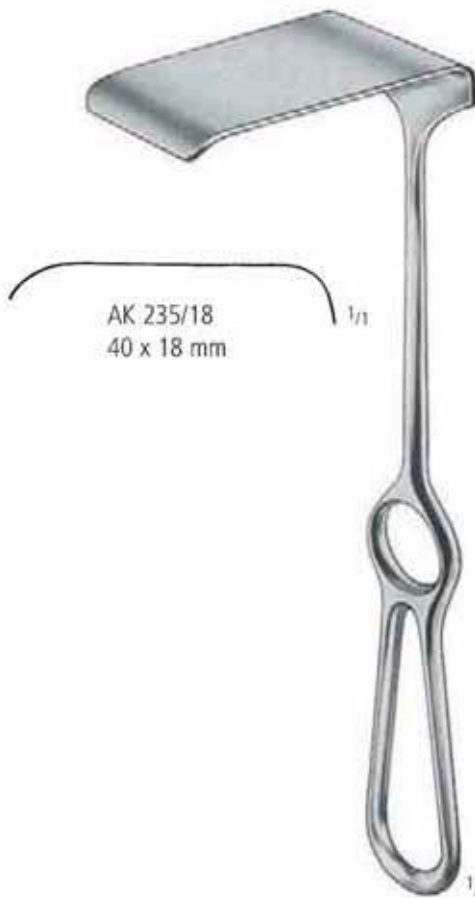

AK 235/18
40 x 18 mm

KOCHER
23,0 cm/9"



AK 236/01
44 x 16 mm

SAUERBRUCH
22,5 cm/8³/₄"

AA
AB
AC
AD
AE
AF
AK
AL
AO
AP
AR
KA
KL
KM
KO
KU
KYE
X



LAHEY
AK 242/19
19,0 cm/7 1/2"



LITTLE
AK 243/20
20,0 cm/8"



MIDDELDORPF
AK 244/17-30



14 X 17 mm

AK 244/17
AK 245/17
21,5 cm/8 1/2"



20 X 22 mm

AK 244/22
AK 245/22
22,0 cm/8 3/4"



26 X 30 mm

AK 244/30
AK 245/30
23,5 cm/9 1/5"



MIDDELDORPF
AK 245/17-30



RICHARDSON (KELLY)
24,0 cm/9¹/₂"

AA
AB
AC
AD
AE
AF
AK
AL
AO
AP
AR
KA
KL
KM
KO
KU
KYE
X

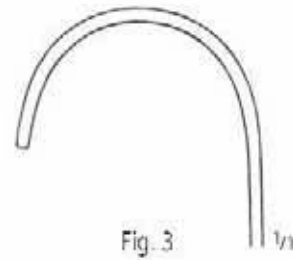
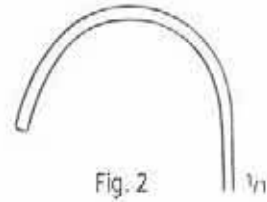
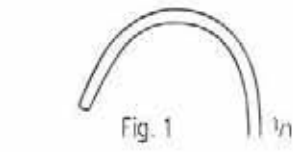

ROUX

16,5 cm/6 1/2"

- | | |
|------------|-----------|
| Fig. 1+2+3 | AK 350/00 |
| Fig. 1 | AK 350/01 |
| Fig. 2 | AK 350/02 |
| Fig. 3 | AK 350/03 |

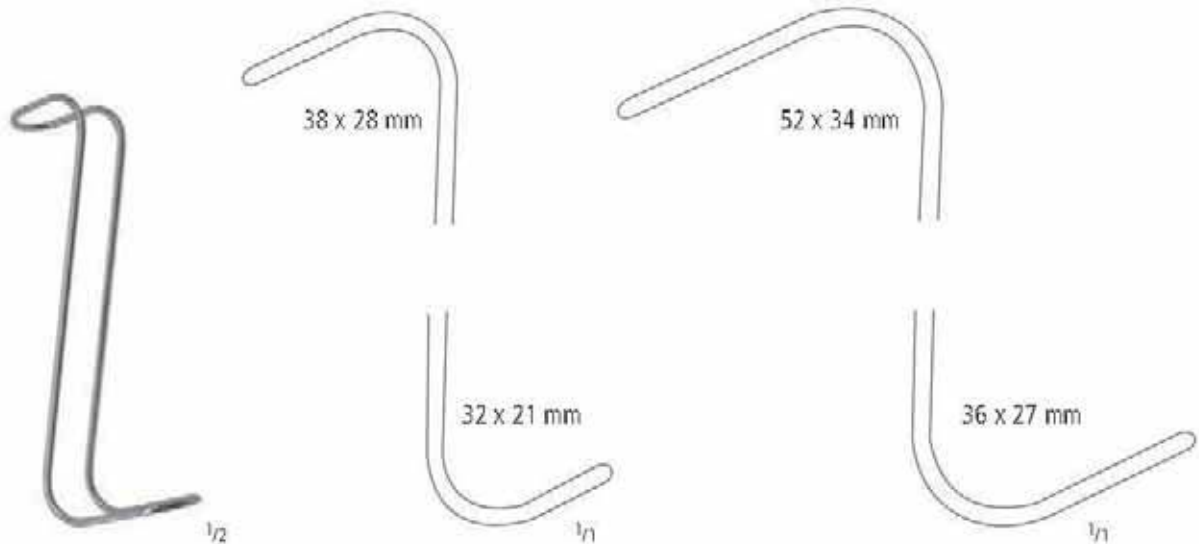

COLLIN-HARTMANN

- | | |
|----------------|-----------|
| 14,0 cm/5 1/2" | AK 351/14 |
| 16,0 cm/6 1/4" | AK 351/16 |



Fig. 1 AK 352/01
Fig. 2 AK 352/02

FARABEU
AK 352/00 Fig. 1+2
12,0 cm/4³/₄"



Fig. 1 AK 354/01
Fig. 2 AK 354/02

FARABEU
AK 354/00 Fig. 1+2
15,0 cm/6"



Fig. 1 AK 373/01
Fig. 2 AK 373/02

PARKER
AK 373/00 Fig. 1+2
13,5 cm/5¹/₄"



Wundhaken mit Kaltlichtbeleuchtung
Retractor with fiberoptic illumination



FERREIRA
AK 451/10
10 cm/4"

AK 452/15



optischer Retraktor
optical retractor

Zur Verwendung mit Optiken Ø 4 mm, Länge 175 mm
For use with telescopes Ø 4 mm, 175 mm

AK 453/20

WUNDHAKEN RETRACTORS SEPARADORES ECARTEURS DIVARICATORI

Selbsthaltende Wundsperrer
Selfretaining Retractors
Separadores autoestaticos
Ecarteurs autostatiques
Divaricatori autostatici



FINSEN

	^	
5,0 cm/2"	AK 500/05	AK 501/05
7,0 cm/2 ³ / ₄ "	AK 500/07	AK 501/07



	^	^
AK 502/10		AK 503/10
	10,0 cm/4"	



ALM

	^	^
7,0 cm/2 ³ / ₄ "	AK 506/07	AK 507/07
10,0 cm/4"	AK 506/10	AK 507/10



JANSEN

	^	^
AK 510/10		AK 511/10
	10,0 cm/4"	



JANSEN

	^	^
AK 512/10		AK 513/10
	10,0 cm/4"	



SNITMAN

	^	^
AK 514/10		AK 515/10
	10,5 cm/4 ¹ / ₄ "	

AA
AB
AC
AD
AE
AF
AK
AL
AO
AP
AR
KA
KL
KM
KO
KU
KYE
X

AK WUNDHAKEN RETRACTORS SEPARADORES ECARTEURS DIVARICATORI

Selbsthaltende Wundsperrer
Selfretaining Retractors
Separadores autoestaticos
Ecarteurs autostatiques
Divaricatori autostatici



WEITLANER-BABY
AK 519/14
14,0 cm/5 1/2"

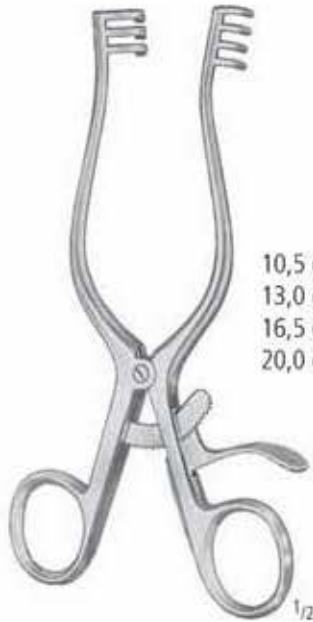

WEITLANER

10,5 cm/4 1/4"
13,0 cm/5"
16,5 cm/6 1/2"
20,0 cm/8"

2 x 3
3 x 4
3 x 4
3 x 4

△
AK 522/10
AK 524/13
AK 526/16
AK 528/20

∩
AK 523/10
AK 525/13
AK 527/16
AK 529/20

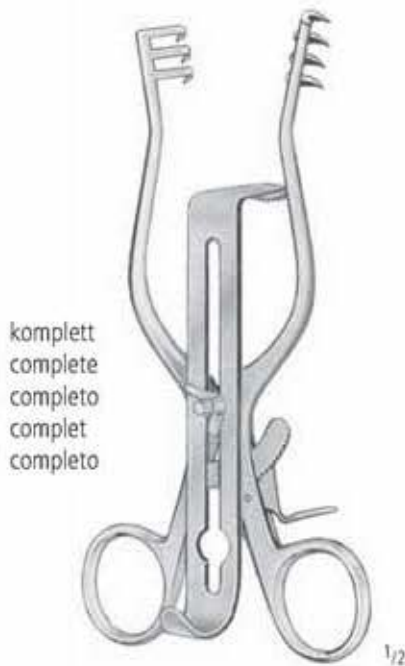

komplett
complete
completo
complet
completo

HENLEY

△ AK 536/00 ∩ AK 537/00
16,5 cm/6 1/2"



19 mm x 16 mm
AK 536/19



25 mm x 16 mm
AK 536/25



32 mm x 16 mm
AK 536/32

WUNDHAKEN RETRACTORS SEPARADORES ECARTEURS DIVARICATORI

Selbsthaltende Wundsperrer
Selfretaining Retractors
Separadores autoestáticos
Ecarteurs autostatiques
Divaricatori autostatici



MILLIGAN

AK 538/13 AK 539/13
13,0 cm/5"



SCHUHKNECHT

AK 542/14 AK 543/14
14,0 cm/5 1/2"



WULLSTEIN

10,5 cm/4 1/4" AK 544/10 AK 545/10
13,0 cm/5" AK 544/13 AK 545/13
16,0 cm/6 1/4" AK 544/16 AK 545/16



MOLLISON

AK 550/15 AK 551/15
15,0 cm/6"

AA
AB
AC
AD
AE
AF
AK
AL
AO
AP
AR
KA
KL
KM
KO
KU
KYE
X

AK WUNDHAKEN RETRACTORS SEPARADORES ECARTEURS DIVARICATORI

Selbsthaltende Wundsperrer
Selfretaining Retractors
Separadores autoestaticos
Ecarteurs autostatiques
Divaricatori autostatici



ADSON-BABY
AK 562/14
14,0 cm/5¹/₂"



CONE
3 x 4
AK 564/13 AK 565/13
13,0 cm/5"



SCALP-CONTOUR
AK 574/14 AK 575/14
14,0 cm/5¹/₂"



PLESTER
AK 590/10 AK 590/13
10,0 cm/4" 13,0 cm/5"



PLESTER-R
AK 591/10 AK 591/13
10,0 cm/4" 13,0 cm/5"



PLESTER-L
AK 592/10 AK 592/13
10,0 cm/4" 13,0 cm/5"



TÜBINGER MODELL
AK 594/16 AK 594/18
16,5 cm/6¹/₂" 18,0 cm/7"

SONDEN PROBES SONDAS SONDES SONDE

Sonden
Probes
Sondas
Sondes
Sonde



Silber
silver
de plata
en argent
d'argento



	1,0 mm	2,0 mm
11,5 cm/4 1/2"	AL 001/11	AL 002/11
13,0 cm/5"	AL 001/13	AL 002/13
14,5 cm/5 3/4"	AL 001/14	AL 002/14
16,0 cm/6 1/4"	AL 001/16	AL 002/16
18,0 cm/7"	AL 001/18	AL 002/18
20,0 cm/8"	AL 001/20	AL 002/20
25,0 cm/10"	AL 001/25	AL 002/25

AL 003/11
AL 003/13
AL 003/14
AL 003/16
AL 003/18
AL 003/20
AL 003/25

MYRTLE LEAF

AL 007/14
AL 007/16
AL 007/18
AL 007/20

STACKE
AL 013/10
10,5 cm/4 1/4"
Ø 1,0 mm



11,5 cm/4 1/2"	AL 015/11
13,0 cm/5"	AL 015/13
14,5 cm/5 3/4"	AL 015/14
16,0 cm/6 1/4"	AL 015/16
18,0 cm/7"	AL 015/18
20,0 cm/8"	AL 015/20

DOYEN
AL 017/14

AL 020/11
AL 020/13
AL 020/14
AL 020/16
AL 020/18

NELATON
AL 022/16

AA
AB
AC
AD
AE
AF
AK
AL
AO
AP
AR
KA
KL
KM
KO
KU
KYE
X

AL SONDEN PROBES SONDAS SONDES SONDE

Sonden und Watteträger
 Probes and Cotton Applicators
 Sondas y Porta-algodones
 Sondes et Porte-coton
 Sonde e Portacotone

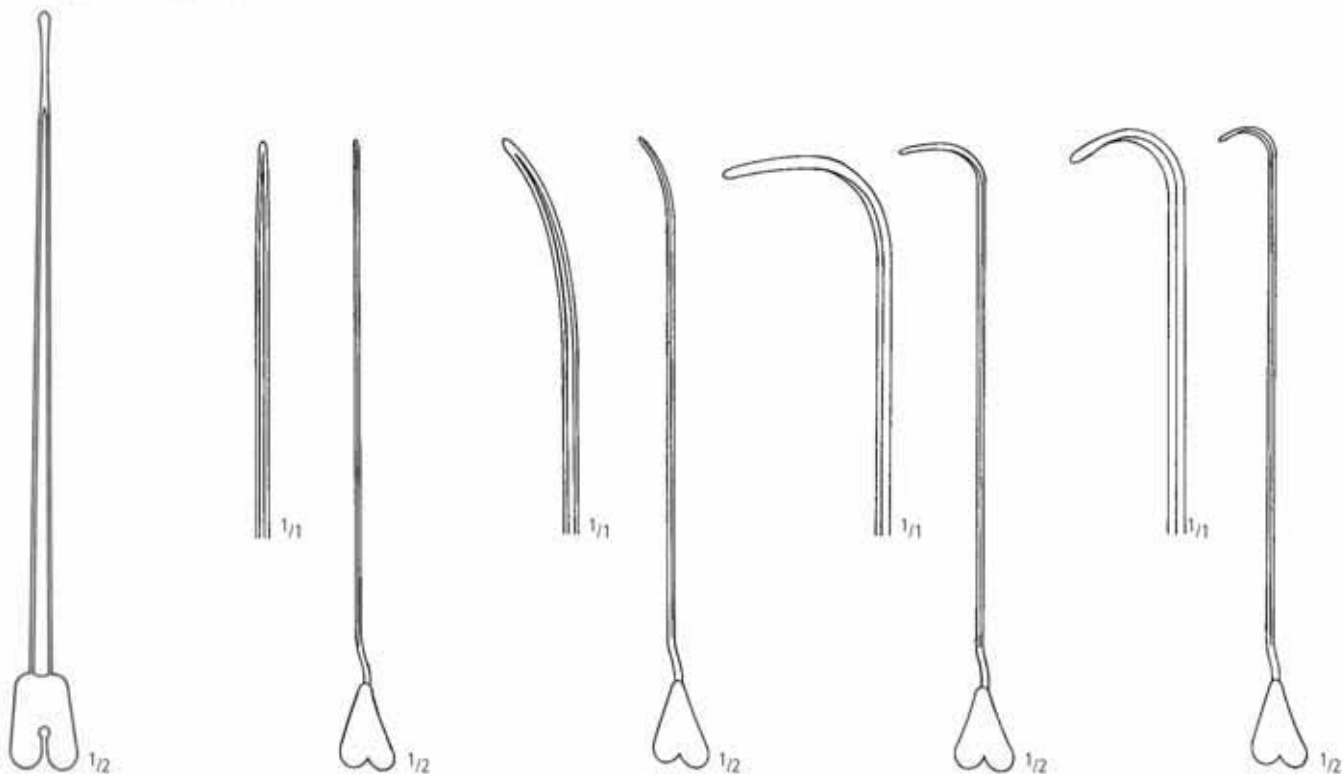

BRODIE

AL 026/20
 20,0 cm/8"

LOCKHART-MUMMERY

Fig. 1
 AL 030/01

Fig. 2
 AL 030/02

LOCKHART-MUMMERY

Fig. 3
 AL 030/03

Fig. 4
 AL 030/04

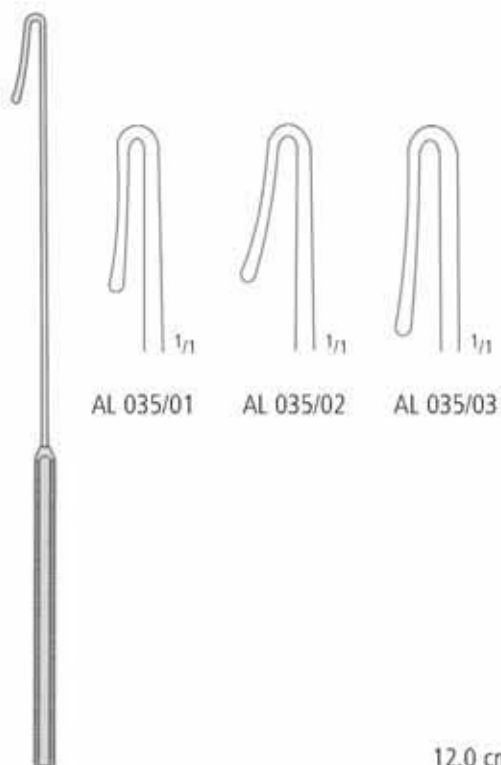

PRATT

21,0 cm/8¹/₄"

AL 035/01

AL 035/02

AL 035/03

FARRELL

12,0 cm/4³/₄" AL 100/12
 14,0 cm/5¹/₂" AL 100/14
 16,5 cm/6¹/₂" AL 100/16
 18,0 cm/7" AL 100/18



FARRELL

0,9 mm AL 120/12
 1,1 mm AL 120/14
 1,2 mm AL 120/16
 1,2 mm AL 120/18



Watteträger
Cotton Applicators
Porta-algodones
Porte-coton
Portacotone



UCKERMANN
AL 160/16
16,0 cm/6 1/4"

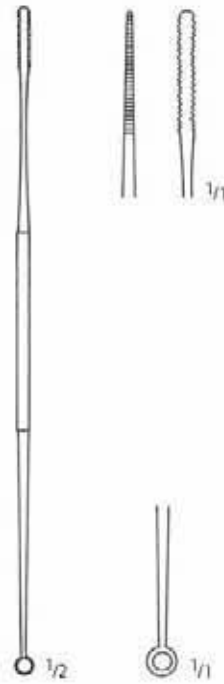

JOBSON-HORNE
AL 162/18
18,0 cm/7"

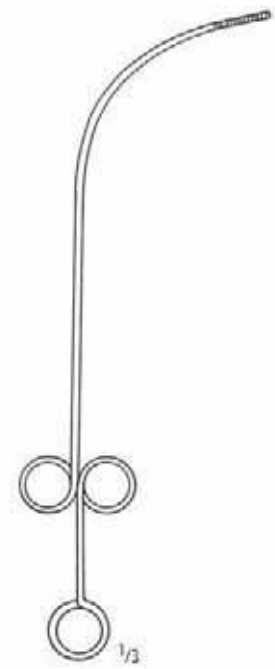

FEIN
AL 170/28
28,0 cm/11"

AA
AB
AC
AD
AE
AF
AK
AL
AO
AP
AR
KA
KL
KM
KO
KU
KYE
X

Trokare
Trocars
Trocars
Trocarts
Trequarti

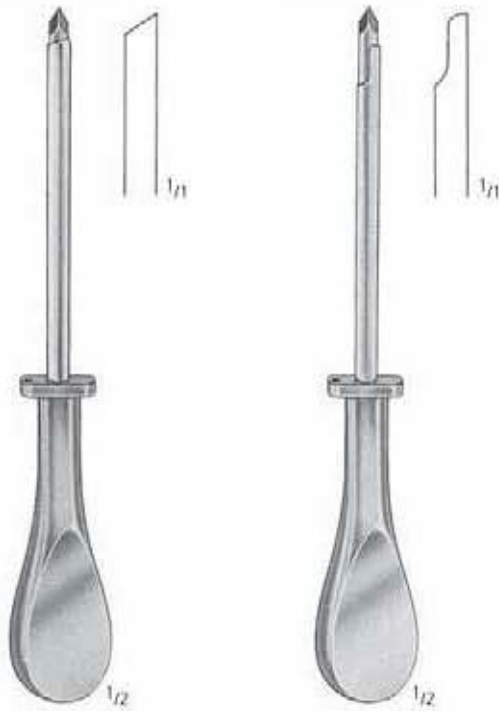

SINUSCOPY

L (mm)	Ø 3,3 mm	Ø 5,0 mm	Ø 5,0 mm
75	AO 080/01		
85		AO 080/10	
110		AO 080/15	AO 080/25

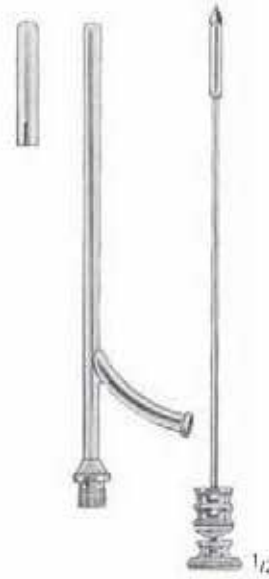

OCHSNER

Char. 10	AO 160/10
Char. 12	AO 160/12
Char. 14	AO 160/14
Char. 16	AO 160/16
Char. 18	AO 160/18
Char. 20	AO 160/20



LANDAU

AO 170/16
16,0 cm/6 1/4"
2,0 mm

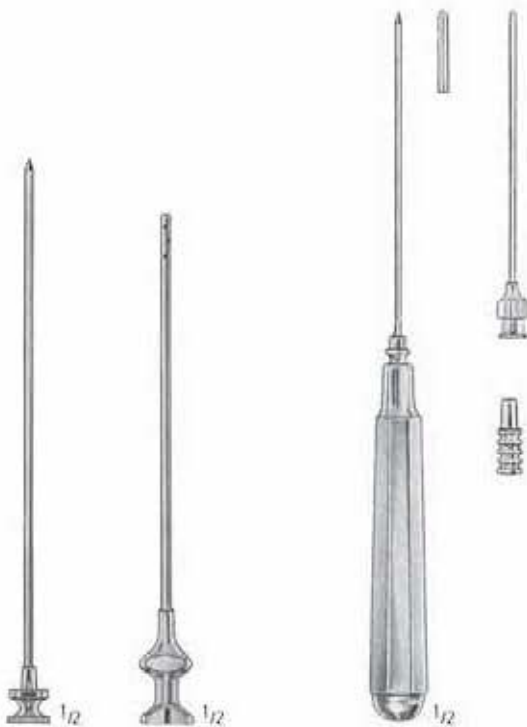

EICKEN

1,8 x 105 mm	AO 176/18
2,0 x 105 mm	AO 176/20
3,0 x 105 mm	AO 176/30

LICHTWITZ

AO 180/00
1,8 mm



LICHTWITZ

AO 182/00
1,6 mm



DOUGLAS

AO 185/00
3,0 mm

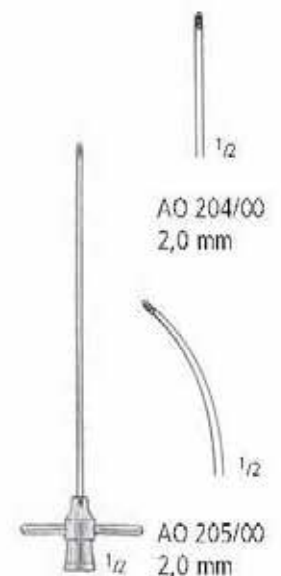

RUSKIN

AO 204/00
2,0 mm

AO 205/00
2,0 mm

AA
AB
AC
AD
AE
AF
AK
AL
AO
AP
AR
KA
KL
KM
KO
KU
KVE
X

Saugrohre
Suction Tubes
Tubos de aspiración
Canules d'aspiration
Cannule per aspirazione



COUPLAND
AO 410/00



BYRD
1,5 mm AO 412/15
2,5 mm AO 412/25
3,5 mm AO 412/35



POOLE
AO 420/22
10,0 mm



POOLE
AO 421/22
8,0 mm



BABY-POOLE
AO 422/20
5,5 mm

Saugrohre
Suction Tubes
Tubos de aspiración
Canules d'aspiration
Cannule per aspirazione



FRAZIER

6 Charr.	AO 430/06
8 Charr.	AO 430/08
10 Charr.	AO 430/10
12 Charr.	AO 430/12



PLESTER

1,5 mm	AO 432/15
2,0 mm	AO 432/20
2,5 mm	AO 432/25
3,0 mm	AO 432/30

complete with
suction tube
+ cannula 0,5 mm
+ cannula 0,7 mm
+ cannula 0,9 mm



FERGUSSON

5 Charr.	AO 434/05
6 Charr.	AO 434/06
7 Charr.	AO 434/07
8 Charr.	AO 434/08
9 Charr.	AO 434/09
10 Charr.	AO 434/10
12 Charr.	AO 434/12



EICKEN-KILLIAN

AO 436/03
13,0 cm/5"
Ø 3 mm



**WULLSTEIN
MICRO**

AO 438/00

AA
AB
AC
AD
AE
AF
AK
AL
AO
AP
AR
KA
KL
KM
KO
KU
KYE
X

Saugrohre
Suction Tubes
Tubos de aspiración
Canules d'aspiration
Cannule per aspirazione



HOUSE

0,9 + 0,7 mm	KM 830/09
1,2 + 0,9 mm	KM 830/12
1,5 + 1,2 mm	KM 830/15
1,8 + 1,8 mm	KM 830/18
2,5 + 2,0 mm	KM 830/25
3,0 + 2,0 mm	KM 830/30
4,5 + 2,0 mm	KM 830/45



BARON (SCHUKNECHT)

1,0 mm x 75 mm	KM 832/10
1,5 mm x 75 mm	KM 832/15
2,0 mm x 75 mm	KM 832/20



ZÖLLNER
KM 835/00



Ø 0,5 mm KM 835/05
Ø 0,7 mm KM 835/07



WULLSTEIN
KM 836/00



WULLSTEIN
KM 837/00



HOUSE

0,6 mm	KM 838/06
0,8 mm	KM 838/08
1,0 mm	KM 838/10
1,2 mm	KM 838/12
1,5 mm	KM 838/15
1,8 mm	KM 838/18
2,0 mm	KM 838/20
2,2 mm	KM 838/22
2,5 mm	KM 838/25
3,0 mm	KM 838/30

Saugrohre, Saugraspatorien
 Suction Tubes, Suction Raspatories
 Tubos de aspiración, Legras de succión
 Canules d'aspiration, Rugines aspirantes
 Cannule per aspirazione, Periototomi aspiranti

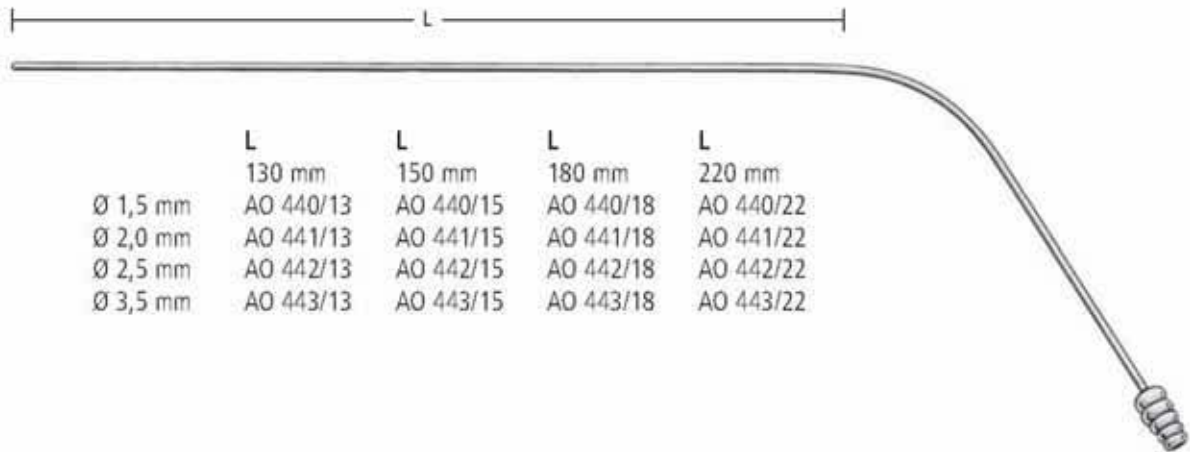

	L	L	L	L
	130 mm	150 mm	180 mm	220 mm
Ø 1,5 mm	AO 440/13	AO 440/15	AO 440/18	AO 440/22
Ø 2,0 mm	AO 441/13	AO 441/15	AO 441/18	AO 441/22
Ø 2,5 mm	AO 442/13	AO 442/15	AO 442/18	AO 442/22
Ø 3,5 mm	AO 443/13	AO 443/15	AO 443/18	AO 443/22



ADSON
 AO 450/04
 21,0 cm/8¹/₄"
 Ø 4,0 mm



AO 453/20
 20,0 cm/8"
 Ø 4,0 mm

AA
 AB
 AC
 AD
 AE
 AF
 AK
 AL
 AO
 AP
 AR
 KA
 KL
 KM
 KO
 KU
 KYE
 X

Handgriffe für Liposuktions- und Infiltrationskanülen mit Luer-Lock Ansatz
 Handles for Liposuction and infiltration cannulae with Luer-Lock connection
 Mangos para cánulas de liposucción y infiltración con empalme Luer-Lock
 Manches pour canules de liposuction et infiltration avec embout Luer-Lock
 Manici per cannule di liposuzione e infiltrazione con attacco Luer-Lock



AG 501/01



AG 501/02



AG 501/03

Liposuktions- und Infiltrationskanülen mit Luer-Lock Ansatz
 Liposuction and infiltration cannulae with Luer-Lock connection
 Cánulas de liposucción y infiltración con empalme Luer-Lock
 Canules de liposucción et infiltration avec avec embout Luer-Lock
 Cannule di liposuzione e infiltrazione con attacco Luer-Lock

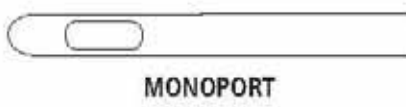

MONOPORT

Länge / length	150 mm	200 mm	250 mm	300 mm
Ø 2 mm	AO 505/01	AO 505/02	AO 505/03	AO 505/04
Ø 3 mm	AO 505/05	AO 505/06	AO 505/07	AO 505/08
Ø 4 mm	AO 505/09	AO 505/10	AO 505/11	AO 505/12
Ø 5 mm	AO 505/13	AO 505/14	AO 505/15	AO 505/16



TRIPORT

Länge / length	150 mm	200 mm	250 mm	300 mm
Ø 2 mm	AO 506/01	AO 506/02	AO 506/03	AO 506/04
Ø 3 mm	AO 506/05	AO 506/06	AO 506/07	AO 506/08
Ø 4 mm	AO 506/09	AO 506/10	AO 506/11	AO 506/12
Ø 5 mm	AO 506/13	AO 506/14	AO 506/15	AO 506/16



MERCEDES

Länge / length	150 mm	200 mm	250 mm	300 mm
Ø 2 mm	AO 507/01	AO 507/02	AO 507/03	AO 507/04
Ø 3 mm	AO 507/05	AO 507/06	AO 507/07	AO 507/08
Ø 4 mm	AO 507/09	AO 507/10	AO 507/11	AO 507/12
Ø 5 mm	AO 507/13	AO 507/14	AO 507/15	AO 507/16



SPIRALE

Länge / length	150 mm	200 mm	250 mm	300 mm
Ø 2 mm	AO 508/01	AO 508/02	AO 508/03	AO 508/04
Ø 3 mm	AO 508/05	AO 508/06	AO 508/07	AO 508/08
Ø 4 mm	AO 508/09	AO 508/10	AO 508/11	AO 508/12
Ø 5 mm	AO 508/13	AO 508/14	AO 508/15	AO 508/16



SHARK

Länge / length	150 mm	200 mm	250 mm	300 mm
Ø 2 mm	AO 509/01	AO 509/02	AO 509/03	AO 509/04
Ø 3 mm	AO 509/05	AO 509/06	AO 509/07	AO 509/08
Ø 4 mm	AO 509/09	AO 509/10	AO 509/11	AO 509/12
Ø 5 mm	AO 509/13	AO 509/14	AO 509/15	AO 509/16



COBRA

Länge / length	150 mm	200 mm	250 mm	300 mm
Ø 2 mm	AO 510/01	AO 510/02	AO 510/03	AO 510/04
Ø 3 mm	AO 510/05	AO 510/06	AO 510/07	AO 510/08
Ø 4 mm	AO 510/09	AO 510/10	AO 510/11	AO 510/12
Ø 5 mm	AO 510/13	AO 510/14	AO 510/15	AO 510/16

AA
AB
AC
AD
AE
AF
AK
AL
AO
AP
AR
KA
KL
KM
KO
KU
KYE
X

Handgriffe für Liposuktions- und Infiltrationskanülen mit Schnellverriegelung
 Handles for Liposuction and infiltration cannulae with quick connector
 Mangos para cánulas de liposucción y infiltración con aseguramiento rápido
 Manches pour canules de liposuction et infiltration avec raccordement rapide
 Manici per cannule di liposuzione e infiltrazione con chiusura rapida



AG 501/11



AG 501/12



AG 501/13

Liposuktions- und Infiltrationskanülen mit Schnellverriegelung
 Liposuction and infiltration cannulae with quick connector
 Cánulas de liposucción y infiltración con aseguramiento rápido
 Canules de liposuction et infiltration avec raccordement rapide
 Cannule di liposuzione e infiltrazione con chiusura rapida

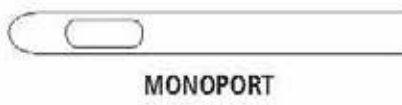

MONOPORT

Länge / length	150 mm	200 mm	250 mm	300 mm
Ø 2 mm	AO 515/01	AO 515/02	AO 515/03	AO 515/04
Ø 3 mm	AO 515/05	AO 515/06	AO 515/07	AO 515/08
Ø 4 mm	AO 515/09	AO 515/10	AO 515/11	AO 515/12
Ø 5 mm	AO 515/13	AO 515/14	AO 515/15	AO 515/16



TRIPORT

Länge / length	150 mm	200 mm	250 mm	300 mm
Ø 2 mm	AO 516/01	AO 516/02	AO 516/03	AO 516/04
Ø 3 mm	AO 516/05	AO 516/06	AO 516/07	AO 516/08
Ø 4 mm	AO 516/09	AO 516/10	AO 516/11	AO 516/12
Ø 5 mm	AO 516/13	AO 516/14	AO 516/15	AO 516/16



MERCEDES

Länge / length	150 mm	200 mm	250 mm	300 mm
Ø 2 mm	AO 517/01	AO 517/02	AO 517/03	AO 517/04
Ø 3 mm	AO 517/05	AO 517/06	AO 517/07	AO 517/08
Ø 4 mm	AO 517/09	AO 517/10	AO 517/11	AO 517/12
Ø 5 mm	AO 517/13	AO 517/14	AO 517/15	AO 517/16

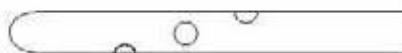

SPIRALE

Länge / length	150 mm	200 mm	250 mm	300 mm
Ø 2 mm	AO 518/01	AO 518/02	AO 518/03	AO 518/04
Ø 3 mm	AO 518/05	AO 518/06	AO 518/07	AO 518/08
Ø 4 mm	AO 518/09	AO 518/10	AO 518/11	AO 518/12
Ø 5 mm	AO 518/13	AO 518/14	AO 518/15	AO 518/16



SHARK

Länge / length	150 mm	200 mm	250 mm	300 mm
Ø 2 mm	AO 519/01	AO 519/02	AO 519/03	AO 519/04
Ø 3 mm	AO 519/05	AO 519/06	AO 519/07	AO 519/08
Ø 4 mm	AO 519/09	AO 519/10	AO 519/11	AO 519/12
Ø 5 mm	AO 519/13	AO 519/14	AO 519/15	AO 519/16

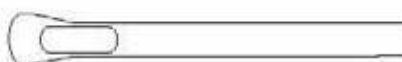

COBRA

Länge / length	150 mm	200 mm	250 mm	300 mm
Ø 2 mm	AO 520/01	AO 520/02	AO 520/03	AO 520/04
Ø 3 mm	AO 520/05	AO 520/06	AO 520/07	AO 520/08
Ø 4 mm	AO 520/09	AO 520/10	AO 520/11	AO 520/12
Ø 5 mm	AO 520/13	AO 520/14	AO 520/15	AO 520/16

AA
AB
AC
AD
AE
AF
AK
AL
AO
AP
AR
KA
KL
KM
KO
KU
KYE
X

Liposuktions- und Infiltrationskanülen mit festem Handgriff
 Liposuction and infiltration cannulae with fixed handle
 Cánulas de liposucción y infiltración con mango fijo
 Canules de liposucción et infiltration avec manche arrêté
 Cannule di liposuzione e infiltrazione con manico fisso

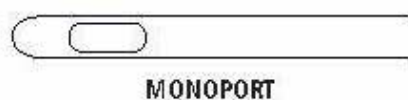

Länge / length	150 mm	200 mm	250 mm	300 mm
Ø 2 mm	AO 525/01	AO 525/02	AO 525/03	AO 525/04
Ø 3 mm	AO 525/05	AO 525/06	AO 525/07	AO 525/08
Ø 4 mm	AO 525/09	AO 525/10	AO 525/11	AO 525/12
Ø 5 mm	AO 525/13	AO 525/14	AO 525/15	AO 525/16



Länge / length	150 mm	200 mm	250 mm	300 mm
Ø 2 mm	AO 526/01	AO 526/02	AO 526/03	AO 526/04
Ø 3 mm	AO 526/05	AO 526/06	AO 526/07	AO 526/08
Ø 4 mm	AO 526/09	AO 526/10	AO 526/11	AO 526/12
Ø 5 mm	AO 526/13	AO 526/14	AO 526/15	AO 526/16

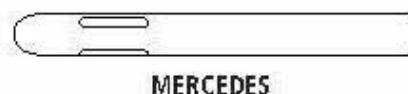

Länge / length	150 mm	200 mm	250 mm	300 mm
Ø 2 mm	AO 527/01	AO 527/02	AO 527/03	AO 527/04
Ø 3 mm	AO 527/05	AO 527/06	AO 527/07	AO 527/08
Ø 4 mm	AO 527/09	AO 527/10	AO 527/11	AO 527/12
Ø 5 mm	AO 527/13	AO 527/14	AO 527/15	AO 527/16



Länge / length	150 mm	200 mm	250 mm	300 mm
Ø 2 mm	AO 528/01	AO 528/02	AO 528/03	AO 528/04
Ø 3 mm	AO 528/05	AO 528/06	AO 528/07	AO 528/08
Ø 4 mm	AO 528/09	AO 528/10	AO 528/11	AO 528/12
Ø 5 mm	AO 528/13	AO 528/14	AO 528/15	AO 528/16



Länge / length	150 mm	200 mm	250 mm	300 mm
Ø 2 mm	AO 529/01	AO 529/02	AO 529/03	AO 529/04
Ø 3 mm	AO 529/05	AO 529/06	AO 529/07	AO 529/08
Ø 4 mm	AO 529/09	AO 529/10	AO 529/11	AO 529/12
Ø 5 mm	AO 529/13	AO 529/14	AO 529/15	AO 529/16

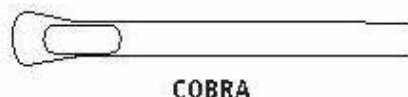

Länge / length	150 mm	200 mm	250 mm	300 mm
Ø 2 mm	AO 530/01	AO 530/02	AO 530/03	AO 530/04
Ø 3 mm	AO 530/05	AO 530/06	AO 530/07	AO 530/08
Ø 4 mm	AO 530/09	AO 530/10	AO 530/11	AO 530/12
Ø 5 mm	AO 530/13	AO 530/14	AO 530/15	AO 530/16

Spritzen
Syringes
Jeringas
Seringues
Siringhe

AA
AB
AC
AD
AE
AF
AK
AL
AO
AP
AR
KA
KL
KO
KU
KYE
X



disposable
20 ml AO 875/02



disposable
60 ml AO 875/06



glass
50 ml AO 869/05



JANET
50 ml AO 870/05
100 ml AO 870/10
150 ml AO 870/15
200 ml AO 870/20



50 ml AO 871/05
100 ml AO 871/10
150 ml AO 871/15
200 ml AO 871/20

Hähne und Verbindungsstücke
 Stopcocks and connecting pieces
 Llaves y Piezas de conexión
 Robinets et Raccords
 Rubinetti e Raccordi



AO 910/00



AO 911/00



AO 912/00



AO 913/00



AO 914/00



AO 915/00



AO 916/00



AO 917/00



AO 918/00



AO 920/00

links
 left
 izquierda
 gauche
 sinistra



rechts
 right
 derecha
 droite
 destra

AO 921/01

AO 921/02



AO 922/00



AO 923/00



AO 924/00



AO 925/00

Laryngoskope
Laryngoscopes
Laringoscopios
Laryngoscopes
Laringoscoopi



AP 252/00
Fig. 0, 55 mm



AP 252/01
Fig. 1, 75 mm



AP 252/02
Fig. 2, 90 mm



AP 252/03
Fig. 3, 110 mm



AP 252/04
Fig. 4, 135 mm

McINTOSH



AP 250/00 (90 mm + 110 mm + 135 mm)

AP 250/01 (75 mm + 90 mm + 110 mm + 135 mm)

komplett - complete - completo - complet - completo

AA
AB
AC
AD
AE
AF
AK
AL
AO
AP
AR
KA
KL
KM
KO
KU
KYE
X

Laryngoskope
Laryngoscopes
Laringoscopios
Laryngoscopes
Laringoscopi



AP 262/00
Fig. 0, 70 mm



AP 262/01
Fig. 1, 95 mm



AP 262/02
Fig. 2, 110 mm



AP 262/03
Fig. 3, 140 mm



AP 262/04
Fig. 4, 170 mm



FOREGGER (WISCONSIN)



AP 260/00 (110 mm + 140 mm + 170 mm)

AP 260/01 (95 mm + 110 mm + 140 mm + 170 mm)

komplett - complete - completo - complet - completo

Laryngoskope
Laryngoscopes
Laringoscopios
Laryngoscopes
Laringoscoopi



AP 272/00
Fig. 0, 55 mm



AP 272/01
Fig. 1, 80 mm



AP 272/02
Fig. 2, 130 mm



AP 272/03
Fig. 3, 170 mm



AP 272/04
Fig. 4, 180 mm



MILLER



AP 270/00 (130 mm + 170 mm + 180 mm)

AP 270/01 (80 mm + 130 mm + 170 mm + 180 mm)

komplett - complete - completo - complet - completo

AA
AB
AC
AD
AE
AF
AK
AL
AO
AP
AR
KA
KL
KM
KO
KU
KYE
X

Laryngoskope
Laryngoscopes
Laringoscopios
Laryngoscopes
Laringoscopi



AP 280/19
Ø 19 mm



AP 280/28
Ø 28 mm



AP 280/37
Ø 37 mm



AP 281/00



AP 282/00
Fig. 2-4



AP 284/00
Fig. 0-1

Kaltlicht Laryngoskope
 Fibre Optic Laryngoscopes
 Laringoscopios con luz fría
 Laryngoscopes à lumière froide
 Laringoscopi a luce fredda

McINTOSH FIBRE OPTIC



AP 300/00 (80 mm + 105 mm + 130 mm)
 AP 300/01 (70 mm + 80 mm + 105 mm + 130 mm)

komplett - complete - completo - complet - completo



Fig. 0,	55 mm	AP 302/00
Fig. 1,	70 mm	AP 302/01
Fig. 2,	80 mm	AP 302/02
Fig. 3,	105 mm	AP 302/03
Fig. 4,	130 mm	AP 302/04

AA
 AB
 AC
 AD
 AE
 AF
 AG
 AH
 AI
 AJ
 AK
 AL
 AM
 AN
 AO
 AP
 AQ
 AR
 AS
 AT
 AU
 AV
 AW
 AX

Kaltlicht Laryngoskope
 Fibre Optic Laryngoscopes
 Laringoscópios con luz fría
 Laryngoscopes à lumière froide
 Laringoscopi a luce fredda

FOREGGER (WISCONSIN) FIBRE OPTIC



AP 310/00 (110 mm + 140 mm + 170 mm)
 AP 310/01 (95 mm + 110 mm + 140 mm + 170 mm)

komplett - complete - completo - complet - completo



Fig. 0,	70 mm	AP 312/00
Fig. 1,	95 mm	AP 312/01
Fig. 2,	110 mm	AP 312/02
Fig. 3,	140 mm	AP 312/03
Fig. 4,	170 mm	AP 312/04

Kaltlicht Laryngoskope
 Fibre Optic Laryngoscopes
 Laringoscopios con luz fría
 Laryngoscopes à lumière froide
 Laringoscopi a luce fredda

MILLER FIBRE OPTIC



AP 320/00 (80 mm + 130 mm + 170 mm)
 AP 320/01 (80 mm + 130 mm + 170 mm + 180 mm)

komplett - complete - completo - complet - completo



J

Fig. 0,	55 mm	AP 322/00
Fig. 1,	80 mm	AP 322/01
Fig. 2,	130 mm	AP 322/02
Fig. 3,	170 mm	AP 322/03
Fig. 4,	180 mm	AP 322/04

AA
AB
AC
AD
AE
AF
AK
AL
AO
AP
AR
KA
KL
KM
KO
KU
KYE
X

Kaltlicht Laryngoskope
 Fibre Optic Laryngoscopes
 Laringoscopios con luz fría
 Laryngoscopes à lumière froide
 Laringoscopi a luce fredda

FIBRE OPTIC



AP 340/00
 Ø 30 mm



AP 341/00
 Ø 20 mm



AP 345/01
 2,5 V
 Halogen



AP 345/02
 2,5 V
 Krypton

Katheterzangen
Catheter forceps
Pinzas para catéteres
Pincas pour sondes
Pinze per cannule



MAGILL
AP 410/16
16,0 cm/6 1/4"



MAGILL
AP 410/20
20,0 cm/8"



MAGILL
AP 410/25
25,0 cm/10"

AA
AB
AC
AD
AE
AF
AK
AL
AO
AP
AR
KA
KL
KM
KO
KU
KYE
X

Anschluss Richard Wolf, Adapter oder andere Anschlüsse auf Wunsch
 Richard Wolf connector, adaptor or other connectors on request
 Conector Richard Wolf, adaptador o otros conectores diferentes sobre pedido
 Connection Richard Wolf, adaptateur ou d'autres embouts à la demande
 Connettore Richard Wolf, adattatori ed altri connettori su richiesta

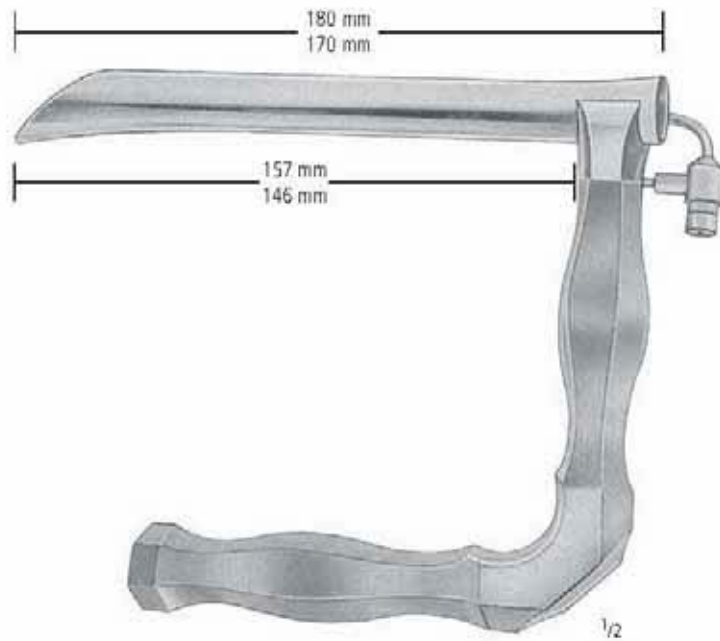

HOLINGER

157 mm = AP 455/01

146 mm = AP 455/02

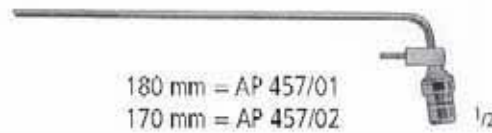

180 mm = AP 457/01

170 mm = AP 457/02

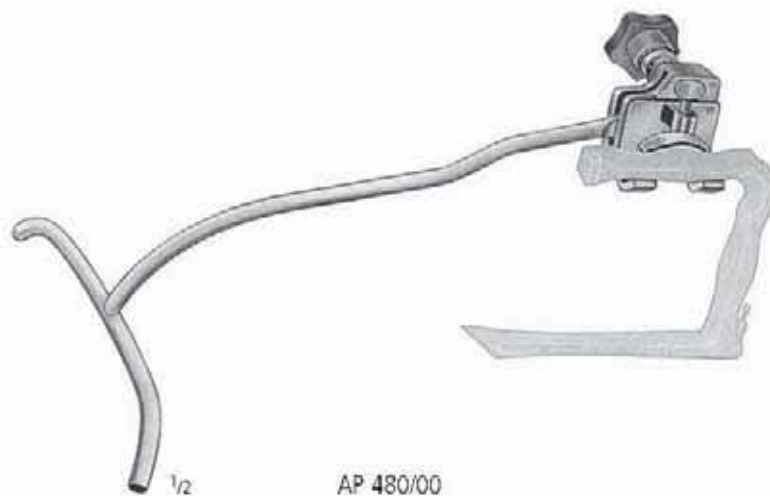

AP 480/00

Kaltlicht Laryngoskope
 Fibre Optic Laryngoscopes
 Laringoscopios con luz fría
 Laryngoscopes à lumière froide
 Laringoscopi a luce fredda

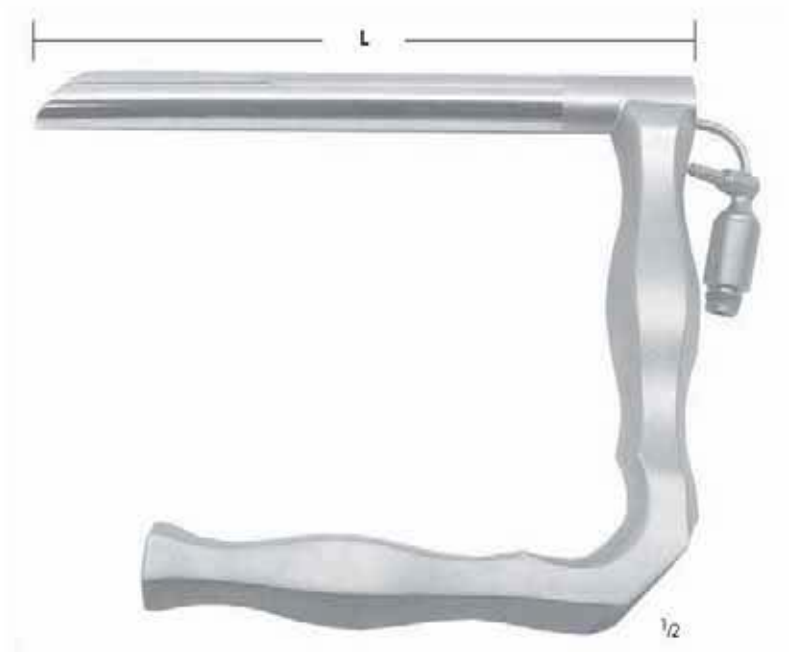

JACKSON

- L = 120 mm = AP 465/12
- L = 160 mm = AP 465/16
- L = 180 mm = AP 465/18



- 120 mm = AP 470/12
- 160 mm = AP 470/16
- 180 mm = AP 470/18

AA
 AB
 AC
 AD
 AE
 AF
 AK
 AL
 AO
AP
 AR
 KA
 KL
 KM
 KO
 KU
 KYE
 X

Stimspiegel
 Head Mirrors
 Espejos frontales
 Miroirs frontaux
 Specchi frontali



AR 091/01
 Ersatzlampe
 Spare Lamp
 Lámpara de repuesto
 Lampe de rechange
 Lampada di ricambio

AR 090/00



90 mm = AR 102/09
 100 mm = AR 102/10

1/2

AA
 AB
 AC
 AD
 AE
 AF
 AK
 AL
 AO
 AP
 AR
 KA
 KL
 KM
 KO
 KU
 KYE
 X

Stirnlampen
 Head Lamps
 Lámparas frontales
 Eclairage frontaux
 Lampade frontali



CLAR 55
 AR 150/55
 6 V



CLAR STANDARD
 AR 160/00
 6 V

DIAGNOSTIK DIAGNOSTICS DIAGNOSTICO DIAGNOSTIC DIAGNOSTICA

Messinstrumente
 Measuring instruments
 Instrumentos para medidas
 Instruments pour mesurer
 Strumenti per misurare



- 15,0 cm/6" AR 250/15
- 20,0 cm/8" AR 250/20
- 30,0 cm/12" AR 250/30
- 50,0 cm/20" AR 250/50



AR 256/15



- AR 258/50 röntgentähig
- 50,0 cm/20" x-ray
- rayos x
- rayons x
- raggi x



VERNIER
 AR 260/12
 12,0 cm/4^{3/4}"



JAMESON
 AR 261/08
 0 - 80 mm / 0 - 3 inch

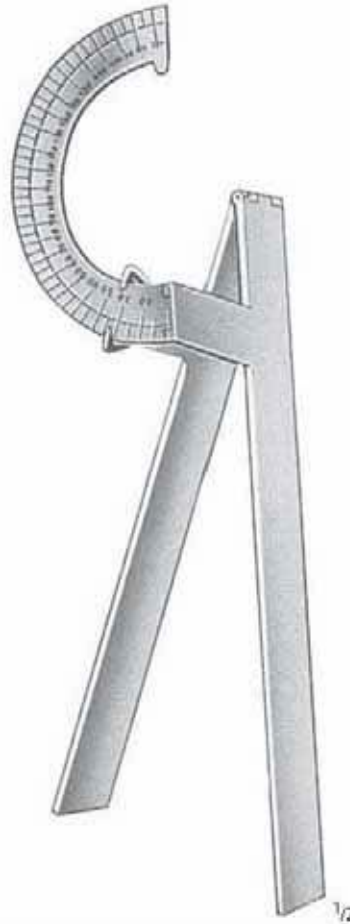

MOELTGEN
 AR 268/00

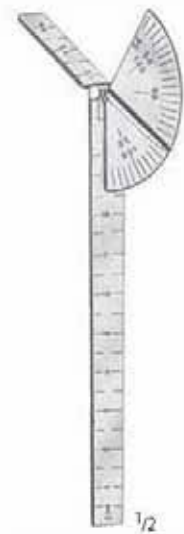

CAROLL
 AR 270/00

AA
 AB
 AC
 AD
 AE
 AF
 AK
 AL
 AO
 AP
 AR
 KA
 KL
 KM
 KO
 KU
 KYE
 X

Messinstrumente
 Measuring Instruments
 Instrumentos para medidas
 Instruments pour mesurer
 Strumenti per misurare



CASTROVIEJO
 AR 282/15
 8,0 cm/ 3"

Messbereich 15 mm
 measuring range 15 mm
 campo de medición 15 mm
 étendue de mesurage 15 mm
 ampiezza di misura 15 mm



CASTROVIEJO
 AR 282/20
 8,0 cm/ 3"

Messbereich 20 mm
 measuring range 20 mm
 campo de medición 20 mm
 étendue de mesurage 20 mm
 ampiezza di misura 20 mm



CASTROVIEJO
 AR 283/20
 8,0 cm/ 3"

Messbereich 20 mm
 measuring range 20 mm
 campo de medición 20 mm
 étendue de mesurage 20 mm
 ampiezza di misura 20 mm

DIAGNOSTIK DIAGNOSTICS DIAGNOSTICO DIAGNOSTIC DIAGNOSTICA

Facelift-Markierer, Sensibilitäts-Instrumente
 Facelift marker, Sensibility Instruments
 Marcador para facelift, Instrumentos sensibilidad
 Marqueur pour facelift, Instruments sensibilités
 Marcatore per facelift, Strumenti per sensibilità



AR 297/16
 16,0 cm/6 1/4"

AR 298/16
 16,0 cm/6 1/4"



ALY
 AR 300/00
 19,0 cm/7 1/2"



WARTENBERG
 AR 301/00

- AA
- AB
- AC
- AD
- AE
- AF
- AK
- AL
- AO
- AP
- AR
- KA
- KL
- KM
- KO
- KU
- KYE
- X

Stethoskope
 Stethoscopes
 Estetoscopios
 Stéthoscopes
 Stetoscopi



CARDIOPHON
 AR 321/00



DUPLEX-LIGHTWEIGHT/BABY
 AR 322/00 100 g

Blutdruckmesser
 Blood Pressure Manometers
 Manómetro para la presión de la sangre
 Tensiómètre à mercure
 Sfigmomanometro a mercurio

mit Velcromanschette
 with velcro cuff
 con brazalet velcro
 avec manchette velcro
 con bracciale velcro



DIPLOMAT
 AR 350/00



PRECISA
 AR 352/00

AA
 AB
 AC
 AD
 AE
 AF
 AG
 AH
 AI
 AJ
 AK
 AL
 AM
 AN
 AO
 AP
 AQ
 AR
 AS
 AT
 AU
 AV
 AW
 AX

Diagnostik-Bestecke
Diagnostic Sets
Juegos para diagnóstico
Trousses à diagnostic
Astucci per diagnostica



ECONOM
AR 400/00

Diagnostik-Bestecke
 Diagnostic Sets
 Juegos para diagnóstico
 Trousses à diagnostic
 Astucci per diagnosti



OTO - / OPHTHALMOSKOP
 AR 402/00



OTOSKOP UNI
 AR 410/00

AA
 AB
 AC
 AD
 AE
 AF
 AK
 AL
 AO
 AP
AR
 KA
 KL
 KM
 KO
 KU
 KYE
 X

ORTHOPÄDIE
ORTHOPAEDIC
ORTOPEDIA
ORTHOPEDIE
ORTOPEDIA

KA

nopa[®] instruments

Weitere Orthopädie-Instrumente finden Sie in unserem Orthopädie-Programm.

For further orthopaedic instruments, kindly refer to our orthopedics assortment.

Para instrumentos de ortopedia adicionales, por favor consulte nuestro programa de ortopedia.

Pour des instruments d'orthopédie supplémentaires, consultez notre gamme d'orthopédie.

Per gli altri strumenti ortopedici, consultare il nostro assortimento de la ortopedia.



Maßtabelle
 Scale
 Tabla de medida
 Tableau de la mesure
 Scala



2,0 mm



3,0 mm



4,0 mm



5,0 mm



6,0 mm



8,0 mm



10,0 mm



12,0 mm



14,0 mm



16,0 mm



18,0 mm



20,0 mm

Weitere Größen finden Sie in unserem Orthopädie-Programm.
 For further sizes kindly refer to our orthopaedics assortment.

Meißel und Osteotome
Chisels, Gouges and Osteotomes
Cinceles y Gubias
Ciseaux-Burins et Ostéotomes
Scalpelli, Osteotomi, Sgorbie



mm	13,5 cm/5 ¹ / ₄ "
8	KA 400/08
10	KA 400/10
12	KA 400/12
14	KA 400/14
16	KA 400/16



mm	13,5 cm/5 ¹ / ₄ "
	KA 401/08
	KA 401/10
	KA 401/12
	KA 401/14
	KA 401/16



mm	13,5 cm/5 ¹ / ₄ "
	KA 402/08
	KA 402/10
	KA 402/12
	KA 402/14
	KA 402/16



mm	HOKE 14,0 cm/5 ¹ / ₂ "
3	KA 404/03
5	KA 404/05
6	KA 404/06
8	KA 404/08
9	KA 404/09



mm	LUCAS 16,0 cm/6 ¹ / ₄ "
4	KA 406/04
6	KA 406/06



mm	LUCAS 16,0 cm/6 ¹ / ₄ "
3	KA 407/03
5	KA 407/05

AA
AB
AC
AD
AE
AF
AK
AL
AO
AP
AR
KA
KL
KM
KO
KU
KYE
X

Meißel und Osteotome
 Chisels, Gauges and Osteotomes
 Cincoles y Gubias
 Ciseaux-Burins et Ostéotomes
 Scalpelli, Osteotomi, Sgorbie



	ALEXANDER
	18,0 cm/7"
mm	
4	KA 418/04
6	KA 418/06
8	KA 418/08
10	KA 418/10
12	KA 418/12
14	KA 418/14



	ALEXANDER
	18,0 cm/7"
mm	
4	KA 419/04
6	KA 419/06
8	KA 419/08
10	KA 419/10
12	KA 419/12
14	KA 419/14



13,5 cm/5 ¹ / ₄ "	17,0 cm/6 ³ / ₄ "
KA 433/02	KA 437/02
KA 433/03	KA 437/03
KA 433/04	KA 437/04
KA 433/05	KA 437/05
KA 433/06	KA 437/06
KA 433/07	KA 437/07
KA 433/08	KA 437/08



PARTSCH		
mm	13,5 cm/5 ¹ / ₄ "	17,0 cm/6 ³ / ₄ "
2	KA 443/02	KA 447/02
3	KA 443/03	KA 447/03
4	KA 443/04	KA 447/04
5	KA 443/05	KA 447/05
6	KA 443/06	KA 447/06
7	KA 443/07	KA 447/07
8	KA 443/08	KA 447/08

Meißel und Osteotome
 Chisels, Gouges and Osteotomes
 Cinceles y Gubias
 Ciseaux-Burins et Ostéotomes
 Scalpelli, Osteotomi, Sgorbie



SMITH-PETERSEN
 20,0 cm/8"

mm	KA 450/06	KA 451/06	KA 452/09	KA 453/09
6	KA 450/06	KA 451/06		
9	KA 450/09	KA 451/09	KA 452/09	KA 453/09
13	KA 450/13	KA 451/13		
14			KA 452/14	KA 453/14
16	KA 450/16	KA 451/16		
19	KA 450/19	KA 451/19	KA 452/19	KA 453/19

AA
 AB
 AC
 AD
 AE
 AF
 AK
 AL
 AO
 AP
 AR
KA
 KL
 KM
 KO
 KU
 KYE
 X

Meißel und Osteotome
 Chisels, Gouges and Osteotomes
 Cinceles y Gubias
 Ciseaux-Burins et Ostéotomes
 Scalpelli, Osteotomi, Sgorbie



HIBBS
 24,0 cm/9¹/₂"

mm
 6 KA 455/06
 13 KA 455/13

KA 456/06
 KA 456/13

KA 457/06
 KA 457/13

KA 458/06
 KA 458/13

KA 459/06
 KA 459/13

Meißel und Osteotome
 Chisels, Gouges and Osteotomes
 Cinceles y Gubias
 Ciseaux-Burins et Ostéotomes
 Scalpelli, Osteotomi, Sgorbie



STILLE
 20,0 cm/8"

mm	KA 460/08	KA 461/08	KA 462/08	KA 463/08
8	KA 460/10	KA 461/10	KA 462/10	KA 463/10
10	KA 460/15	KA 461/15	KA 462/15	KA 463/15
15				

AA
 AB
 AC
 AD
 AE
 AF
 AG
 AH
 AI
 AJ
 AK
 AL
 AM
 AN
 AO
 AP
 AQ
 AR
 AS
KA
 KL
 KM
 KN
 KO
 KP
 KQ
 KR
 KS
 KT
 KU
 KV
 KW
 KY
 KZ
 X

Meißel und Osteotome
 Chisels, Gauges and Osteotomes
 Cinceles y Gubias
 Ciseaux-Burins et Ostéotomes
 Scalpelli, Osteotomi, Sgorbie



MINI-LEXER
 18,0 cm/7"



MINI-LEXER
 18,0 cm/7"



LEXER
 22,0 cm/8³/₄"



LEXER
 22,0 cm/8³/₄"

mm
 4
 6
 7
 8
 10
 12
 15

KA 470/04
 KA 470/06
 KA 470/08
 KA 470/10
 KA 470/12
 KA 470/15

KA 471/04
 KA 471/06
 KA 471/08
 KA 471/10
 KA 471/12
 KA 471/15

KA 472/07
 KA 472/10
 KA 472/15

KA 473/07
 KA 473/10
 KA 473/15

Ferrozellgriff
 Hartpress-Handle
 Mango en "Ferrozell"
 Manche en "Ferrozell"
 Manico in "Ferrozell"

Meißel und Osteotome
Chisels, Gouges and Osteotomes
Cinceles y Gubias
Ciseaux-Burins et Ostéotomes
Scalpelli, Osteotomi, Sgorbie



LEXER
27,5 cm/10³/₄"

mm
5
10 KA 474/10
15 KA 474/15



LEXER
27,5 cm/10³/₄"

KA 475/10
KA 475/15



LEXER
25,0 cm/10"

KA 476/05
KA 476/10
KA 476/15



LEXER
25,0 cm/10"

KA 477/05
KA 477/10
KA 477/15

Ferrozellgriff
Hartpress-Handle
Mango en "Ferrozell"
Manche en "Ferrozell"
Manico in "Ferrozell"

AA
AB
AC
AD
AE
AF
AK
AL
AO
AP
AR
KA
KL
KM
KO
KU
KYE
X

Meißel und Osteotome
 Chisels, Gouges and Osteotomes
 Cinceles y Gubias
 Ciseaux-Burins et Ostéotomes
 Scalpelli, Osteotomi, Sgorbie



COBB
 28,0 cm/11"
 KA 478/01



COBB
 28,0 cm/11"
 KA 478/02



COBB
 28,0 cm/11"
 KA 478/03



COBB
 28,0 cm/11"
 KA 478/04

ORTHOPÄDIE ORTHOPAEDIC ORTOPEDIA ORTHOPEDIE ORTOPEDIA

Meißel und Osteotome
 Chisels, Gouges and Osteotomes
 Cinceles y Gubias
 Ciseaux-Burins et Ostéotomes
 Scalpelli, Osteotomi, Sgorbie

AA
AB
AC
AD
AE
AF
AK
AL
AO
AP
AR
KA
KL
KM
KO
KU
KYE
X



DAHMEN
 30,0 cm/12"

Ferrozellgriff
 Hartpress-Handle
 Mango en "Ferrozell"
 Manche en "Ferrozell"
 Manico in "Ferrozell"

		KA 479/01		KA 479/02		KA 479/03		KA 479/04
		KA 479/05		KA 479/06		KA 479/07		KA 479/08
		KA 479/09		KA 479/10		KA 479/11		KA 479/12
		KA 479/13		KA 479/14		KA 479/15		KA 479/16
		KA 479/17		KA 479/18		KA 479/19		KA 479/20
		KA 479/21		KA 479/22		KA 479/23		KA 479/24
		KA 479/25		KA 479/26		KA 479/27		KA 479/28



Meißel und Osteotome
 Chisels, Gouges and Osteotomes
 Cinceles y Gubias
 Ciseaux-Burins et Ostéotomes
 Scalpelli, Osteotomi, Sgorbie



MINI-LAMBOTTE
 12,5 cm/5"

MINI-LAMBOTTE
 17,0 cm/6³/₄"

LAMBOTTE
 24,0 cm/9¹/₂"

LAMBOTTE
 23,0 cm/9"

mm	
3	KA 480/03
4	KA 480/04
6	KA 480/06
8	KA 480/08
10	KA 480/10
12	KA 480/12
15	KA 480/15

	KA 481/03
	KA 481/04
	KA 481/06
	KA 481/08
	KA 481/10
	KA 481/12
	KA 481/15

mm	
15	KA 482/15

	KA 483/15

Hämmer
Mallets
Martillos
Marteaux
Martelli



KA 520/30
Ø 26 mm
300 g (10³/₄ oz.)

KA 520/34
Ø 28 mm
340 g (12 oz.)

KA 520/40
Ø 30 mm
400 g (14¹/₄ oz.)

1/2

WILLIGER
24,0 cm/9¹/₂"



1/2

COTTLE
KA 531/24
19,0 cm/7¹/₂"
240 g (8¹/₂ oz.)



Ø 30 mm
220 g
(7³/₄ oz.)

1/2

COLLIN
KA 532/22
20,0 cm/8"

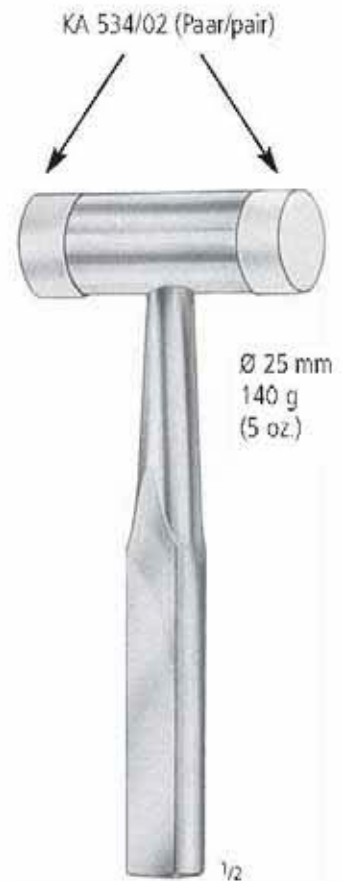

KA 534/02 (Paar/pair)

Ø 25 mm
140 g
(5 oz.)

1/2

KA 534/14
18,0 cm/7"

AA
AB
AC
AD
AE
AF
AK
AL
AO
AP
AR
KA
KL
KM
KO
KU
KYE
X

Hämmer
Mallets
Martillos
Marteaux
Martelli



KA 535/16

KA 536/16

bleigefüllt
lead filled
relleno de plomo
garni de plomb
guarnito di piombo

Messing, massiv
brass, solid
latón, macizo
laiton, solide
ottone, solido

Hämmer
Mallets
Martillos
Marteaux
Martelli



KA 554/90



KA 554/37
370 g (12³/₄ oz.)
Ferrozell



KA 555/13
125 g (4¹/₄ oz.)
Ferrozell

AA
AB
AC
AD
AE
AF
AK
AL
AO
AP
AR
KA
KL
KM
KO
KU
KYE
X

Scharfe Löffel
 Bone Currettes
 Cucharillas cortantes
 Curettes tranchantes
 Curette taglienti



VOLKMANN
 17,0 cm/6³/₄"



Fig. 0000
 KA 600/00



Fig. 000
 KA 601/00



Fig. 00
 KA 602/00



Fig. 0
 KA 603/00



Fig. 1
 KA 603/01



Fig. 2
 KA 603/02



Fig. 3
 KA 603/03



Fig. 4
 KA 603/04



Fig. 5
 KA 603/05



Fig. 6
 KA 603/06

¹/₁



BRUNS
 17,0 cm/6³/₄"



Fig. 000
 KA 610/00



Fig. 00
 KA 611/00



Fig. 0
 KA 612/00



Fig. 1
 KA 612/01



Fig. 2
 KA 612/02



Fig. 3
 KA 612/03



Fig. 4
 KA 612/04



Fig. 5
 KA 612/05



Fig. 6
 KA 612/06

¹/₁

Scharfe Löffel
 Bone Curettes
 Cucharillas cortantes
 Curettes tranchantes
 Curette taglienti



SPRATT
 17,0 cm/6³/₄"



Fig. 000
 KA 615/00



Fig. 00
 KA 616/00



Fig. 0
 KA 617/00



Fig. 1
 KA 617/01



Fig. 2
 KA 617/02



Fig. 3
 KA 617/03



Fig. 4
 KA 617/04



Fig. 5
 KA 617/05



SCHEDE
 17,0 cm/6³/₄"



Fig. 000
 KA 620/00



Fig. 00
 KA 621/00



Fig. 0
 KA 622/00



Fig. 1
 KA 622/01



Fig. 2
 KA 622/02



Fig. 3
 KA 622/03



Fig. 4
 KA 622/04

AA
 AB
 AC
 AD
 AE
 AF
 AK
 AL
 AO
 AP
 AR
KA
 KL
 KM
 KO
 KU
 KYE
 X

Scharfe Löffel
 Bone Currettes
 Cucharillas cortantes
 Curettes tranchantes
 Curette taglienti



2 mm
 KA 623/02



3 mm
 KA 623/03



4 mm
 KA 623/04



5 mm
 KA 623/05



6 mm
 KA 623/06



3 mm
 KA 623/13



4 mm
 KA 623/14



5 mm
 KA 623/15



6 mm
 KA 623/16



FOX

1/2



PIFFARD

1/2



4 mm
 KA 624/01



5 mm
 KA 624/02



6 mm
 KA 624/03

1/1

Scharfe Löffel
 Bone Currettes
 Cucharillas cortantes
 Curettes tranchantes
 Curette taglienti



BRUNS
 23,0 cm/9"

Fig. 000
 KA 625/00

Fig. 00
 KA 625/01

Fig. 0
 KA 625/02

Fig. 1
 KA 625/03

Fig. 2
 KA 625/04

Fig. 3
 KA 625/05

Fig. 4
 KA 625/06

Fig. 5
 KA 625/07

Fig. 6
 KA 625/08



**CLOWARD
 HIBBS SPRATT
 SPINAL FUSION**
 22,5 cm/9"

Fig. 000
 KA 626/00

Fig. 00
 KA 627/00

Fig. 0
 KA 628/00

Fig. 1
 KA 628/01

Fig. 2
 KA 628/02

Fig. 3
 KA 628/03

Fig. 4
 KA 628/04

Fig. 5
 KA 628/05

Fig. 6
 KA 628/06



**CLOWARD
 HIBBS SPRATT
 SPINAL FUSION**
 22,5 cm/9"

Fig. 000
 KA 629/00

Fig. 00
 KA 630/00

Fig. 0
 KA 631/00

Fig. 1
 KA 631/01

Fig. 2
 KA 631/02

Fig. 3
 KA 631/03

Fig. 4
 KA 631/04

Fig. 5
 KA 631/05

Fig. 6
 KA 631/06

AA
 AB
 AC
 AD
 AE
 AF
 AK
 AL
 AO
 AP
 AR
KA
 KL
 KM
 KO
 KU
 KY
 X

Scharfe Löffel
Bone Curettes
Cucharillas cortantes
Curettes tranchantes
Curette taglienti

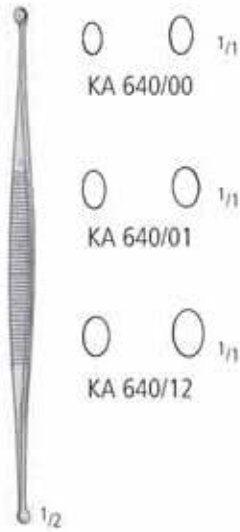

WILLIGER
13,5 cm/5¹/₄"

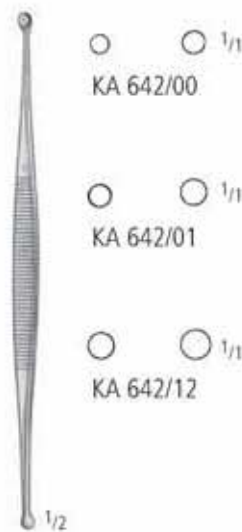

MARTINI
13,5 cm/5¹/₄"



JANSEN
KA 644/16
16,0 cm/6¹/₄"



JANSEN
KA 645/15
15,0 cm/6"



KA 648/21
21,0 cm/8¹/₄"



VOLKMANN KA 650/17
17,0 cm/6³/₄"

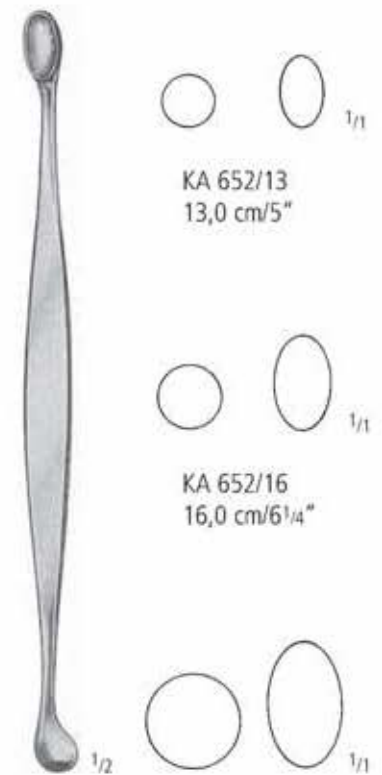

VOLKMANN KA 652/20
20,0 cm/8"

ORTHOPÄDIE ORTHOPAEDIC ORTOPEDIA ORTHOPEDIE ORTOPEDIA

Raspatorien
Raspatories
Raspadores
Rugines-Raspatoires
Periostotomi

AA
AB
AC
AD
AE
AF
AK
AL
AO
AP
AR
KA
KL
KM
KO
KU
KYE
X



KA 665/18
18,0 cm/7"



KA 666/18
18,0 cm/7"



KA 667/18
18,0 cm/7"



KA 668/18
18,0 cm/7"

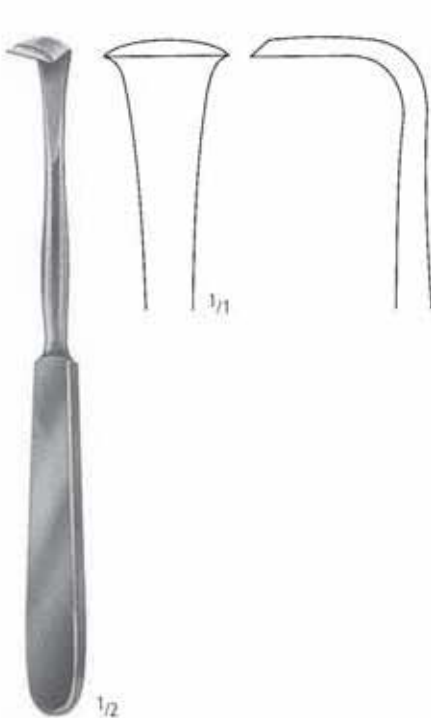

LANGENBECK
KA 671/18
18,0 cm/7"

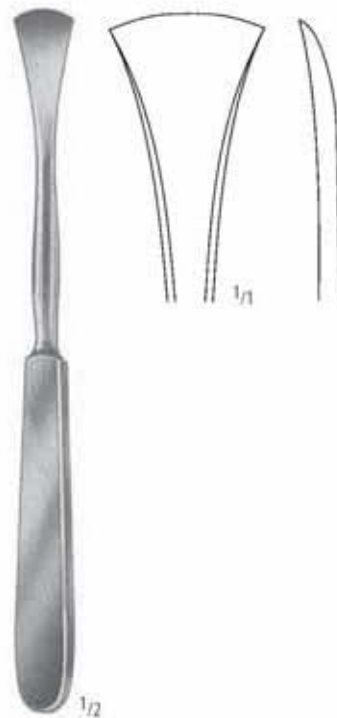

LANGENBECK
KA 672/19
19,0 cm/7 1/2"



16,0 cm/6 1/4"

Raspatorien, Elevatorien
 Raspatories, Elevators
 Raspadores, Elevadores
 Rugines-Raspatoires, Elévateurs
 Periostotomi, Elevatori

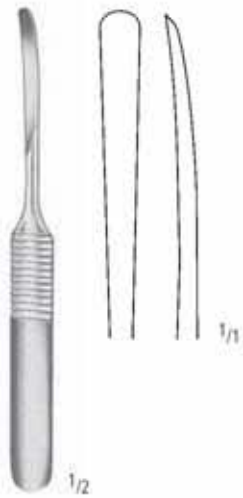

WILLIGER
 KA 680/13
 13,0 cm/5"

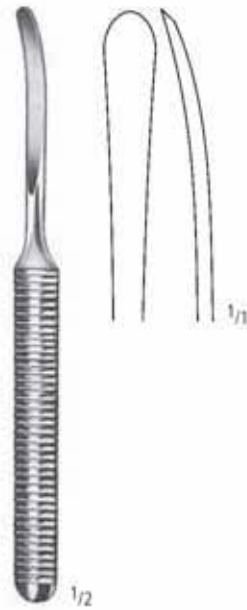

WILLIGER
 KA 680/16
 16,0 cm/6¹/₄"



KA 690/08

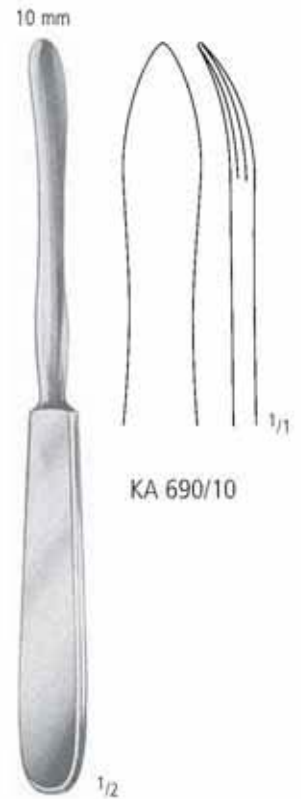

KA 690/10

LANGENBECK
 19,5 cm/7³/₄"



WILLIGER
 KA 692/16
 16,0 cm/6¹/₄"



WILLIGER
 KA 694/17
 17,0 cm/6³/₄"

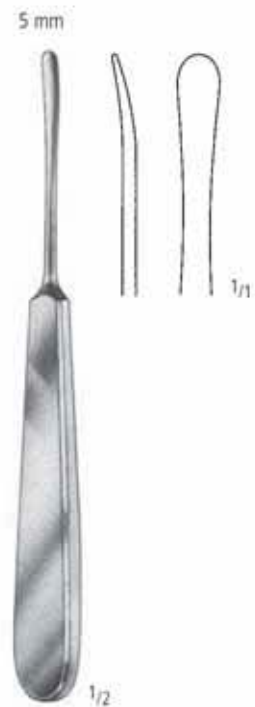

SEBILEAU
 KA 695/05
 17,5 cm/7"

Elevatorien
Elevators
Elevadores
Elévateurs
Elevatori

AA
AB
AC
AD
AE
AF
AK
AL
AO
AP
AR
KA
KL
KM
KO
KU
KYE
X



KA 696/17
17,5 cm/6³/₄"



KA 698/16
16,0 cm/6¹/₄"



ALDERDYCE
KA 699/21
21,0 cm/8¹/₄"



McDONALD
KA 700/19
19,0 cm/7¹/₂"



KA 701/19
scharf
sharp
cortante
tranchant
tagliente

KA 702/19
stumpf
blunt
romo
mousse
smusso

FREER
19,0 cm/7¹/₂"



FREER
KA 703/18
18,0 cm/7"



HOEN

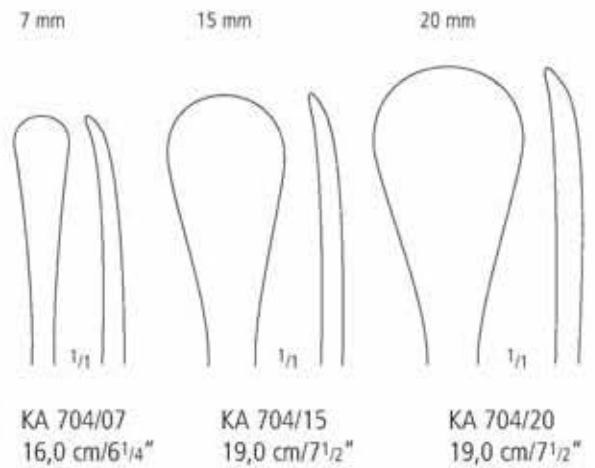

KA 704/07
16,0 cm/6¹/₄"

KA 704/15
19,0 cm/7¹/₂"

KA 704/20
19,0 cm/7¹/₂"

Hohlmeisselzangen
 Bone Rongeurs
 Pinzas-gubias
 Pincès-gouges
 Pinze-sgorbie

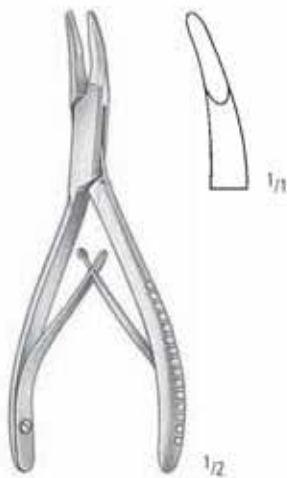

MINI-FRIEDMAN
 KA 800/12
 12,0 cm/5"

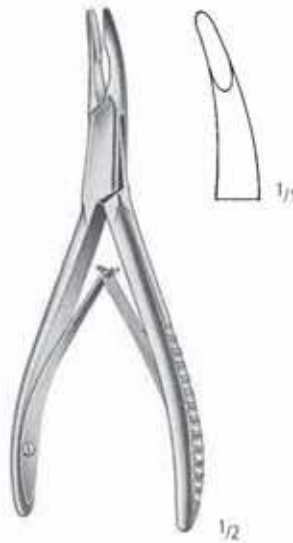

FRIEDMAN
 KA 800/14
 14,0 cm/5 1/2"

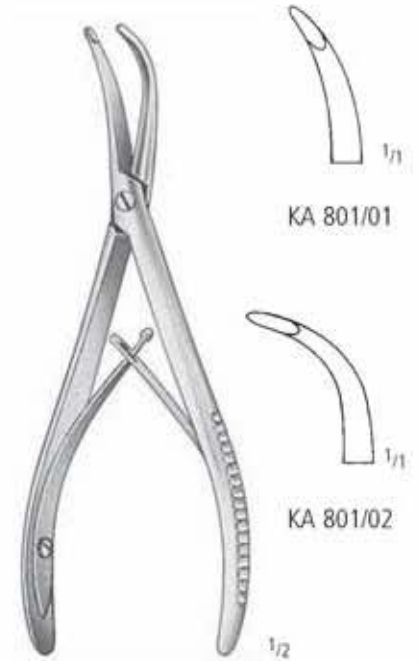

STELLBRINK
 17,0 cm/6 3/4"

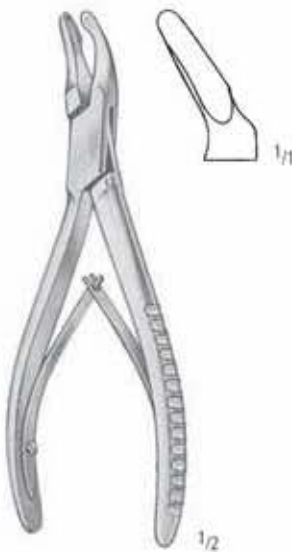

CLEVELAND
 KA 802/14
 14,0 cm/5 1/2"

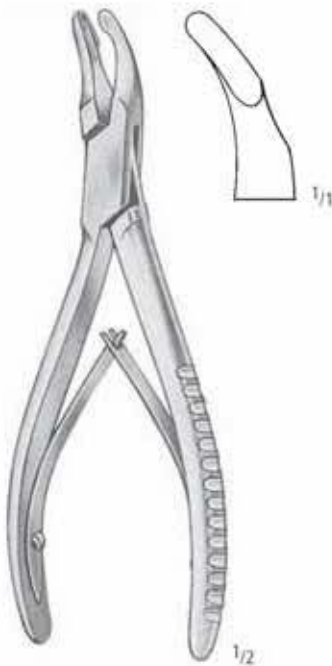

CLEVELAND
 KA 802/17
 17,0 cm/6 3/4"

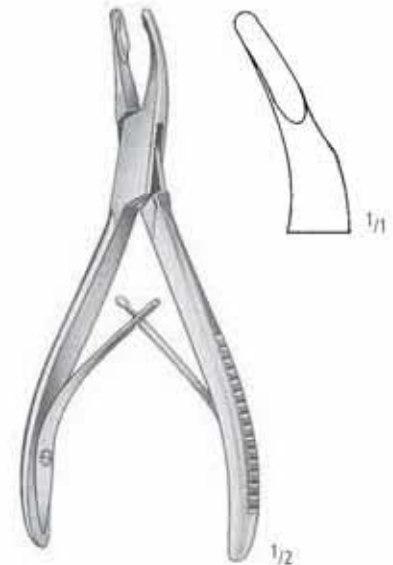

UNIVERSAL
 KA 803/13
 13,5 cm/5 1/4"

Hohlmeisselzangen
 Bone Rongeurs
 Pinzas-gubias
 Pincès-gouges
 Pinze-sgorbie

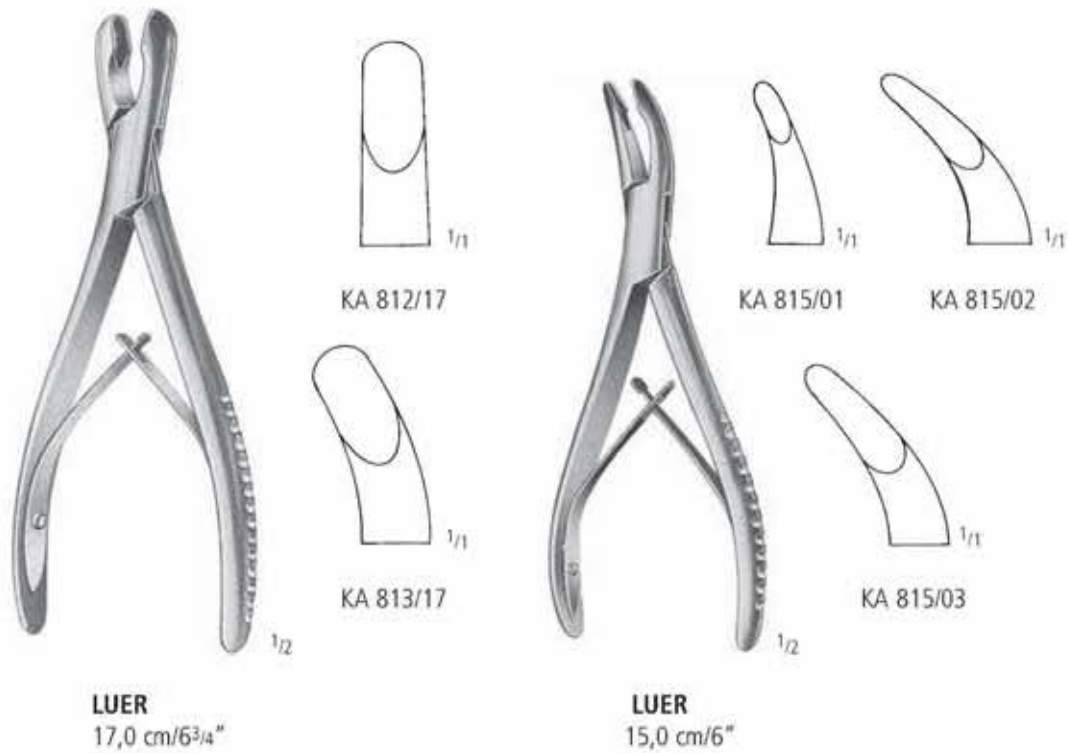
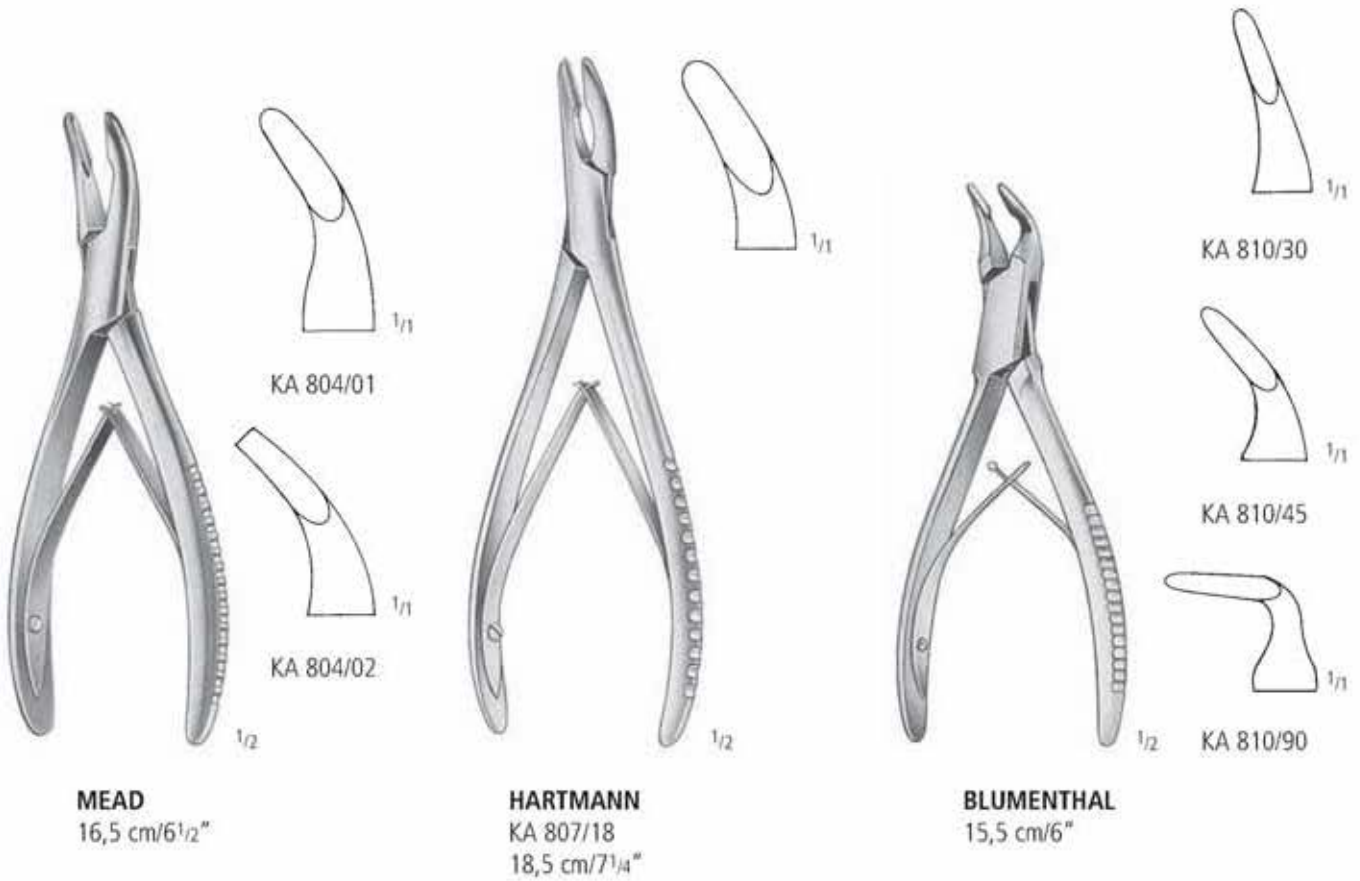

AA
 AB
 AC
 AD
 AE
 AF
 AG
 AH
 AI
 AJ
 AK
 AL
 AO
 AP
 AR
KA
 KL
 KM
 KO
 KU
 KYE
 X

Hohlmeisselzangen
 Bone Rongeurs
 Pinzas-gubias
 Pincès-gouges
 Pinze-sgorbie



LEMPERT
 KA 816/19
 19,0 cm/7 1/2"



BACON
 KA 819/20
 20,0 cm/8"



MARQUARDT
 KA 821/20
 20,0 cm/8"



MAYFIELD
 KA 823/17
 17,0 cm/6 3/4"

Hohlmeißelzangen
 Bone Rongeurs
 Pinzas-gubias
 Pincas-gouges
 Pinze-sgorbie

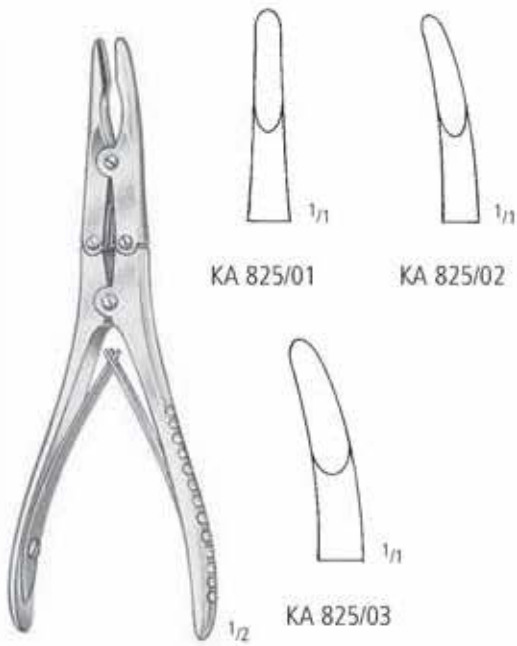

BÖHLER
 15,0 cm/6"

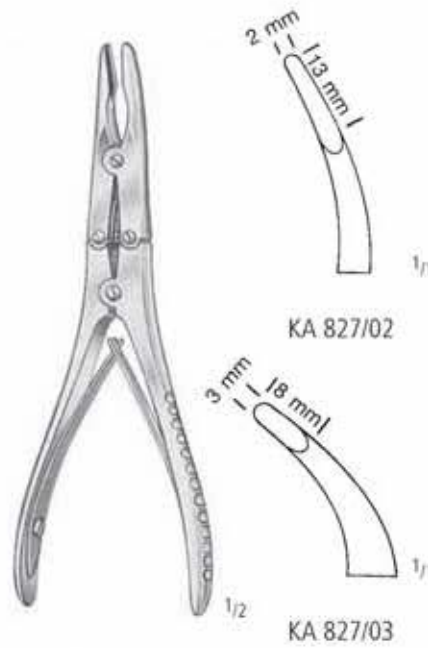

KLEINERT-KUTZ
 15,0 cm/6"

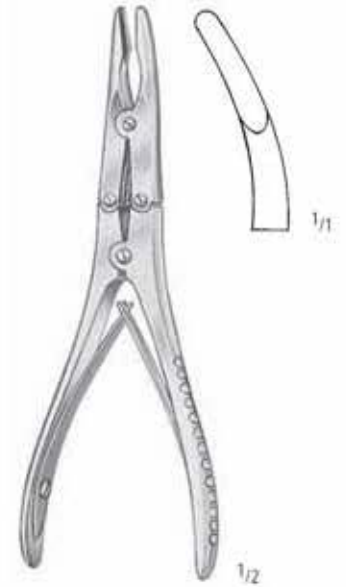

RUSKIN-MINI
 KA 829/15
 15,0 cm/6"



BEYER
 KA 830/18
 18,0 cm/7"



ZAUFAL-JANSEN
 KA 835/18
 18,0 cm/7"

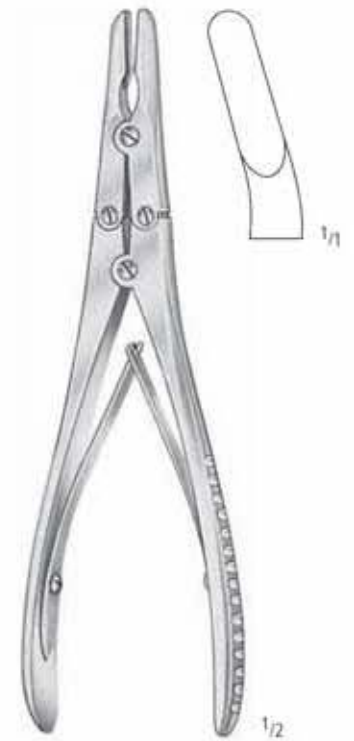

RUSKIN
 KA 836/18
 18,0 cm/7"

AA
 AB
 AC
 AD
 AE
 AF
 AK
 AL
 AO
 AP
 AR
KA
 KL
 KM
 KO
 KU
 KYE
 X

Knochensplitterzangen
 Bone Cutting Forceps
 Pinzas cortantes para huesos
 Pinces coupantes à os
 Cesioie per ossa

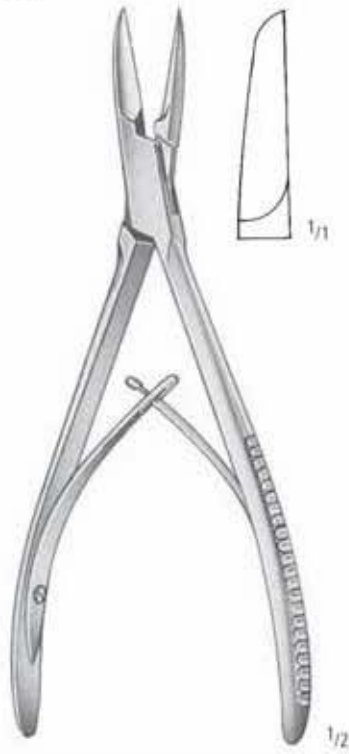

COTTLE KAZANJIAN
 KA 870/19
 19,0 cm/7¹/₂"

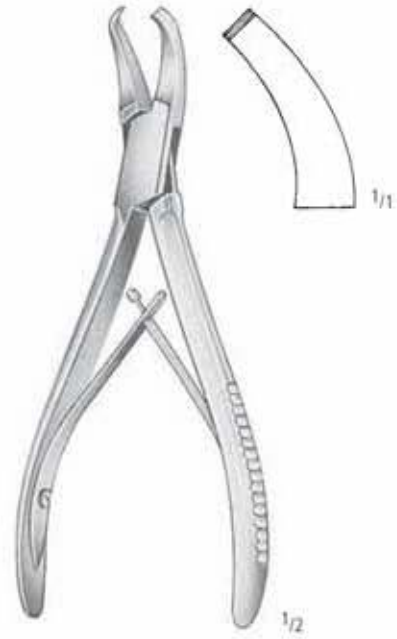

CLEVELAND-GARDNER
 KA 872/16
 18,0 cm/6³/₄"

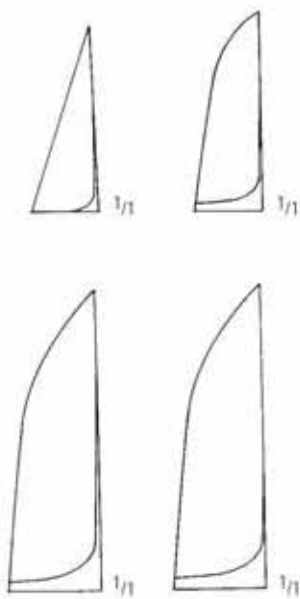

LISTON
 KA 880/14 14,0 cm/5¹/₂"
 KA 880/17 17,0 cm/6³/₄"
 KA 880/19 19,0 cm/7¹/₂"
 KA 880/22 22,0 cm/8³/₄"

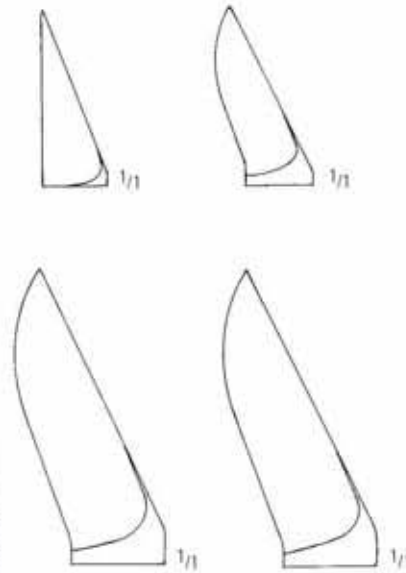

LITTAUER-LISTON
 KA 882/15
 15,0 cm/6"

KA 880/14
 KA 880/17
 KA 880/19
 KA 880/22

KA 881/14
 KA 881/17
 KA 881/19
 KA 881/22

Knochensplitterzangen
 Bone Cutting Forceps
 Pinzas cortantes para huesos
 Pinces coupantes à os
 Cesoie per ossa

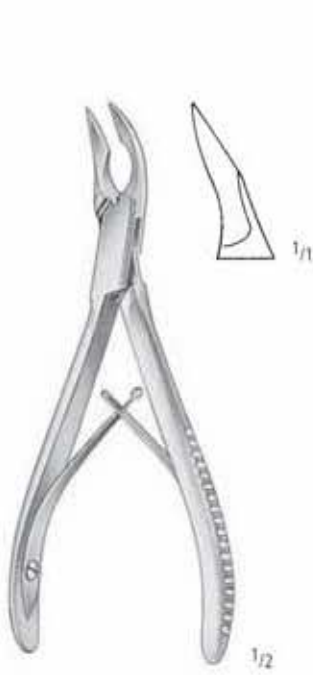

CLEVELAND
 KA 884/15
 15,0 cm/6"

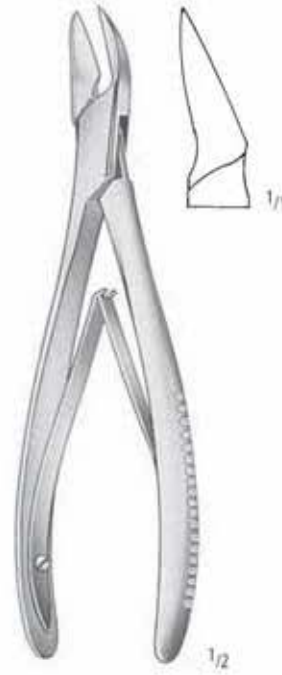

CLEVELAND
 KA 884/17
 17,0 cm/6³/₄"

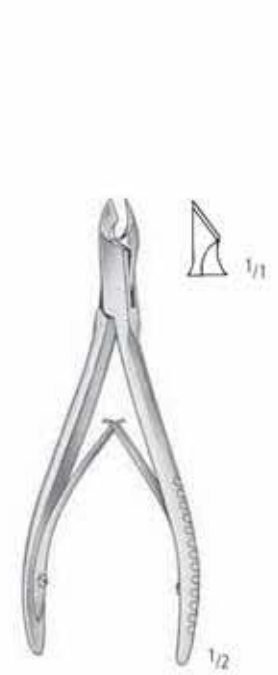

KA 885/12
 12,0 cm/4³/₄"

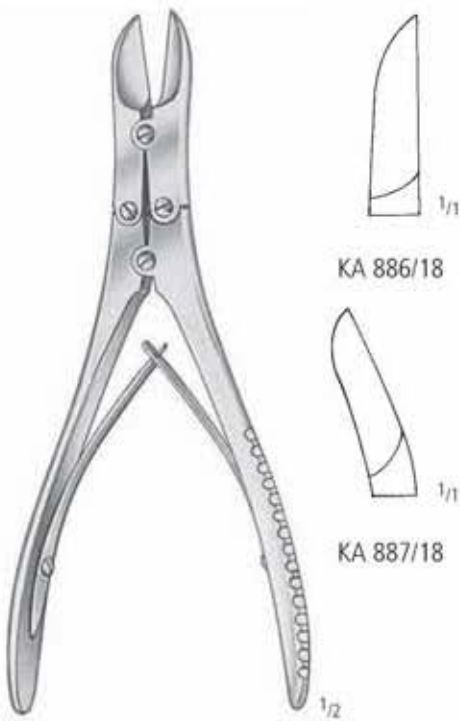

RUSKIN-LISTON
 18,5 cm/7¹/₄"



MC INDOE
 KA 888/17
 17,5 cm/7"



WALTON-LISTON
 KA 889/01
 15,0 cm/6"

AA
 AB
 AC
 AD
 AE
 AF
 AK
 AL
 AO
 AP
 AR
 KA
 KL
 KM
 KO
 KU
 KYE
 X

Repositionszangen
 Reposition forceps
 Pinzas de reposición
 Pincas de reposition
 Pinze per riposizione



ROWE
 KA 2970/23
 23,0 cm/9"



ROWE
 KA 2971/23
 23,0 cm/9"

HNO
ENT
ORL

KL

nopa[®] instruments

Mund	Seite	267-275
Mouth	Page	267-275
Boca	Página	267-275
Bouche	Page	267-275
Bocca	Pagina	267-275
Tracheotomie	Seite	276-280
Tracheotomy	Page	276-280
Traqueotomía	Página	276-280
Tracheotomie	Page	276-280
Tracheotomia	Pagina	276-280
Tonsillen	Seite	281-287
Tonsils	Page	281-287
Amígdalas	Página	281-287
Amygdales	Page	281-287
Tonsille	Pagina	281-287
Laryngologie	Seite	288-296
Laryngology	Page	288-296
Laringología	Página	288-296
Laryngologie	Page	288-296
Laringología	Pagina	288-296



KL MUND MOUTH BOCA BOUCHE BOCCA

Fingerschützer, Mundkeile, Mundsperrer
 Finger Protectors, Oral Wedges, Mouth Gags
 Dedales, Garrotes, Abre-bocas
 Doigtiers, Ballons, Ouvre-bouches
 Ditali, Apribocca



LANGENBECK

KL 015/01 KL 015/02 KL 015/03
 Ø 22,0 mm Ø 24,5 mm Ø 26,5 mm



MAUNDER

KL 018/00



PITHA

KL 020/00



HEISTER

KL 030/13
 13,0 cm/5"



MOLT

KL 040/11
 11,0 cm/4 1/8"



MOLT

KL 040/14
 14,0 cm/5 1/2"

MUND MOUTH BOCA BOUCHE BOCCA

Mundsperrer
Mouth Gags
Abre-bocas
Ouvre-bouches
Apribocca



DENHART
KL 042/12
12,0 cm/4³/₄"



ROSER-KÖNIG
16,0 cm/6¹/₄" KL 044/16
19,0 cm/7¹/₂" KL 044/19



JENNINGS
KL 046/09 9,0 cm/3¹/₂"
KL 046/11 11,0 cm/4¹/₃"
KL 046/13 13,0 cm/5"
KL 046/15 15,0 cm/6"



SEEMANN-SEIFFERT
KL 047/09
KL 047/11
KL 047/13
KL 047/15

AA
AB
AC
AD
AE
AF
AK
AL
AO
AP
AR
KA
KL
KM
KO
KU
KYE
X

KL MUND MOUTH BOCA BOUCHE BOCCA

Mundsperrer
 Mouth Gags
 Abre-bocas
 Ouvre-bouches
 Apribocca

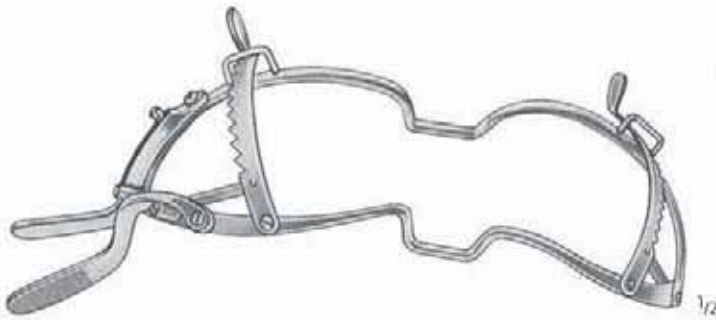

WHITEHEAD

KL 048/11
 KL 048/13
 KL 048/15

11,0 cm/4¹/₃"
 13,0 cm/5"
 15,0 cm/6"

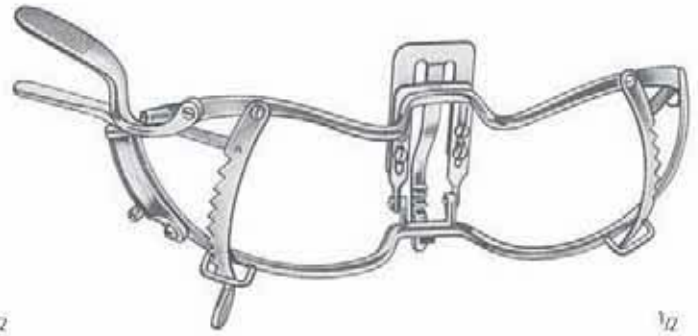

WHITEHEAD

KL 049/11
 KL 049/13
 KL 049/15



KILNER-DOUGHTY

KL 060/00

komplett
 complete
 completo
 complet
 completo



Fig. 1
 KL 060/01
 65x28 mm



Fig. 2
 KL 060/02
 75x32 mm



Fig. 3
 KL 060/03
 80x37 mm



KL 060/08

MUND MOUTH BOCA BOUCHE BOCCA

Mundsperrer
Mouth Gags
Abre-bocas
Ouvre-bouches
Apribocca



Fig. 1
KL 061/01
55x25 mm



Fig. 2
KL 061/02
60x27 mm



Fig. 3
KL 061/03
70x30 mm

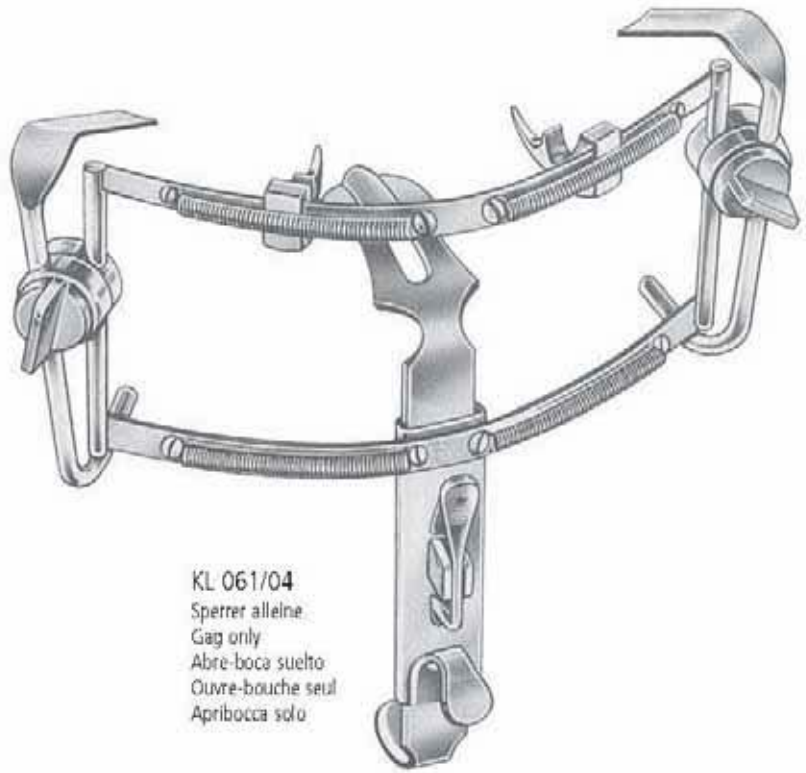

KL 061/04
Sperrer alleine
Gag only
Abre-boca suelto
Ouvre-bouche seul
Apribocca solo

DINGMANN

KL 061/00
komplett
complete
completo
complet
completo

KL 064/08

Silikon
Silicon
Silicon
Silicone
Silicone



KL 064/06
Sperrer alleine
Gag only
Abre-boca suelto
Ouvre-bouche seul
Apribocca solo

DAVIS-BOYLE

KL 064/00
komplett
complete
completo
complet
completo



Fig. 1
KL 064/01
105x27 mm



Fig. 2
KL 064/02
90x25 mm



Fig. 3
KL 064/03
75x25 mm



Fig. 4
KL 064/04
60x22 mm



Fig. 5
KL 064/05
25x20 mm

AA
AB
AC
AD
AE
AF
AK
AL
AO
AP
AR
KA
KL
KM
KO
KU
KYE
X

Mundsperrer
 Mouth Gags
 Abre-bocas
 Ouvre-bouches
 Apribocca



MC IVOR
 KL 066/00
 komplett
 complete
 completo
 complet
 completo

KL 066/04
 Sperrer alleine
 Gag only
 Abre-boca suelto
 Ouvre-bouche seul
 Apribocca solo



Fig. 1
 KL 066/01
 95x27 mm



Fig. 2
 KL 066/02
 85x22 mm



Fig. 3
 KL 066/03
 70x22 mm



MODELL WÜRZBURG

Fig.		
1	66x28 mm	KL 068/01
2	75x32 mm	KL 068/02
3	83x34 mm	KL 068/03
4	93x37 mm	KL 068/04
5	100x38 mm	KL 068/05



NEGUS

KL 072/00
 Bruststütze für Mundsperrer
 Chest support for Mouth Gag
 Soporte contra-pecho para abre-bocas
 Support contre-poitrine pour ouvre-bouches
 Supporto contro-petto per apribocca

ZUNGE TONGUE LENGUA LANGUE LINGUA

Wangen- und Lippenhalter, Zungendrucker
 Cheek and Lip Retractors, Tongue Depressors
 Separadores para mejillas y labios, Abaja-lenguas
 Ecarteurs des joues et des lèvres, Abaisse-langues
 Divaricatori per guancia e labbra, Abbassalingua



SIMPLEX
 KL 100/11
 11,0 cm/4¹/₃"



STERNBERG
 KL 105/12 = 12,0 cm/4³/₄"
 KL 105/14 = 14,0 cm/5¹/₂"
 KL 105/16 = 16,0 cm/6¹/₄"



TOBOLD
 KL 112/14
 14,5 cm/5³/₄"



HARTMANN
 KL 114/15
 15,0 cm/6"



MORITZ-SCHMIDT
 KL 116/19
 19,0 cm/7¹/₂"



WIEDER
 14,5 cm/5³/₄"



KL 120/14
 28 mm

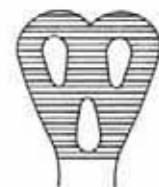

KL 120/15
 32 mm

AA
 AB
 AC
 AD
 AE
 AF
 AK
 AL
 AO
 AP
 AR
 KA
KL
 KM
 KO
 KU
 KYE
 X

KL ZUNGE TONGUE LENGUA LANGUE LINGUA

Wangen- und Lippenhalter, Zungendrucker
 Cheek and Lip Retractors, Tongue Depressors
 Separadores para mejillas y labios, Abaja-lenguas
 Ecarteurs des joues et des lèvres, Abaisse-langues
 Divaricatori per guancie e labbra, Abbassalingua



KL 122/19
 19,0 cm/7¹/₂"



STANDARD
 KL 124/14
 14,5 cm/5³/₄"



UNIV. MINNESOTA
 KL 125/14
 14,0 cm/5¹/₂"



KROENIG
 KL 126/15
 15,0 cm/6"



MAYO
 KL 128/17
 17,0 cm/6³/₄"



BRUENINGS
 KL 130/19
 19,0 cm/7¹/₂"



FRENZEL
 KL 131/16
 16,5 cm/6¹/₂"



KL 132/18
 18,0 cm/7"

ZUNGE TONGUE LENGUA LANGUE LINGUA

Zungenzangen, Trokare, Dilatatoren
 Tongue Holding forceps, Trocars, Dilators
 Pinzas tira-lengua, Traqueótomos, Dilatadores
 Pinces tire-langue, Trachéotomes, Dilatateurs
 Pinze tiralingua, Tracheotomi, Dilatatori



COLLIN
 KL 140/16
 16,0 cm/6 1/4"



KL 144/99
 Paar
 pair
 par
 paire
 palo

YOUNG
 KL 144/17
 17,0 cm/6 3/4"



UCKERMANN

7,5 mm
 KL 150/07

9,0 mm
 KL 150/09



LABORDE
 KL 155/14
 14,0 cm/5 1/2"



**TROUSSE-
 AUKL** 157/14
 14,0 cm/5 1/2"



BOSE
 KL 159/07
 7,0 cm/2 3/4"

AA
 AB
 AC
 AD
 AE
 AF
 AK
 AL
 AO
 AP
 AR
 KA
 KL
 KM
 KO
 KU
 KYE
 X

Tracheal Håkchen
 Trachea Retractors
 Separadores para la tráquea
 Ecarteurs pour trachéotomie
 Undni tracheali



links
 left
 izquierdo
 à gauche
 sinistro

BOSE
 KL 166/01
 16,0 cm/6¹/₄"



rechts
 right
 derecho
 à droite
 destro

BOSE
 KL 166/02
 16,0 cm/6¹/₄"



ITERSON
 16,0 cm/6¹/₄"



SCHOENBORN
 KL 176/21
 21,0 cm/8¹/₄"



LUKENS
 KL 177/17
 17,0 cm/6³/₄"

TRACHEOTOMIE TRACHEOTOMY TRAQUEOTOMIA TRACHEOTOMIE TRACHEOTOMIA

Tracheal-Häkchen
 Trachea Retractors
 Separadores para la tráquea
 Ecarteurs pour trachéotomie
 Uncini tracheali



KL 178/01



KL 178/02

JACKSON
 18,0 cm/7¹/₂"



JACKSON
 KL 179/17
 17,0 cm/6³/₄"



ROSE
 KL 180/13
 13,0 cm/5"



LUER
 KL 181/11
 11,0 cm/4¹/₃"



JACKSON
 KL 182/15
 15,0 cm/6"



NEWS
 KL 183/15
 15,0 cm/6"

AA
 AB
 AC
 AD
 AE
 AF
 AK
 AL
 AO
 AP
 AR
 KA
KL
 KM
 KO
 KU
 KYE
 X

Tracheal-Kanülen
Trachea Tubes
Cánulas traqueales
Canules pour trachéotomie
Canule tracheali

Internationale Größenskala
International scale
Escala internacional
Echelle internationale
Scala internazionale

Fig.	0	1	2	3	4	5	6	7	8	9
Ø mm	4	5	6	7	8	9	10	11	12	13
Charr./Fr.	12	15	18	21	24	27	30	33	36	39
Länge	45	50	55	60	65	70	75	80	85	90

Länge des Außenrohrs
Length of outer tube
Large de la cánula exterior
Longueur du tube exténeur
Lunghezza del tubo esterno

Kunststoff
Plastic
El plástico
Plastique
Materia plastica

Sprechkanüle
Speaking tube
Cánula parlante
Canule parlante
Cannula parlante



Standard



CHEVALIER-JACKSON



65-90 mm

LUER

Fig.	mm Ø	45-90 mm
0	4	KL 200/04
1	5	KL 200/05
2	6	KL 200/06
3	7	KL 200/07
4	8	KL 200/08
5	9	KL 200/09
6	10	KL 200/10
7	11	KL 200/11
8	12	KL 200/12
9	13	KL 200/13

45-90 mm
KL 206/04
KL 206/05
KL 206/06
KL 206/07
KL 206/08
KL 206/09
KL 206/10
KL 206/11
KL 206/12
KL 206/13

KL 210/08
KL 210/09
KL 210/10
KL 210/11
KL 210/12
KL 210/13

TRACHEOTOMIE TRACHEOTOMY TRAQUEOTOMIA TRACHEOTOMIE TRACHEOTOMIA

Tracheotomie-Besteck
 Tracheotomy Set
 Estuche para traqueotomía
 Jeu d'instruments pour trachéotomie
 Set per traqueotomia

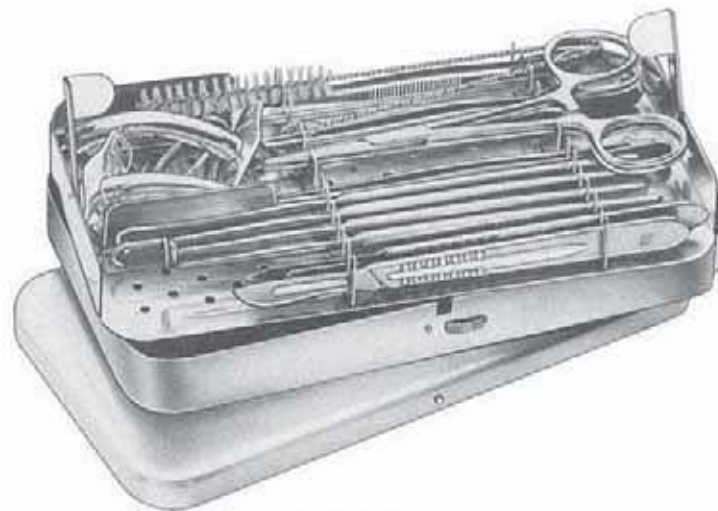

KL 234/00

bestehend aus:

- 1 Metallsetz
- AD 010/04 1 Griff und 1 Klinge Fig. 20
- AD 010/04 1 Griff und 1 Klinge Fig. 23
- AB 050/13 1 Anatomische Pinzette 13,0 cm
- AB 060/13 2 Chirurgische Pinzetten 13,0 cm
- AA 214/13 2 Pean Klemmen 13,0 cm
- AL 015/13 1 Hohlsonde 13,0 cm
- KL 159/07 1 Trachealdilatator Bose
- KL 167/02 2 Trachealhäkchen Iterson, stumpf
- KL 166/01 1 Trachealhäkchen Bose, scharf, links
- KL 166/02 1 Trachealhäkchen Bose, scharf, rechts
- KL 200/07 1 Trachealkanüle Luer Standard, Fig. 2
- KL 200/08 1 Trachealkanüle Luer Standard, Fig. 4
- 1 Reinigungsbürste

compuesto de:

- 1 Estuche de metal
- AD 010/04 1 Mango con 1 hoja fig. 20
- AD 010/04 1 Mango con 1 hoja fig. 23
- AB 050/13 1 Pinza de disección, 13,0 cm
- AB 060/13 2 Pinzas de disección, 13,0 cm, 1:2
- AA 214/13 2 Pean Pinzas hemostáticas, 13,0 cm
- AL 015/13 1 Sonda acanalada, 13,0 cm
- KL 159/07 1 Dilataador traqueal Bose
- KL 167/02 2 Separadores traqueales Iterson, romos
- KL 166/01 1 Separador traqueal, agudo, izquierdo
- KL 166/02 1 Separador traqueal, agudo, derecho
- KL 200/07 1 Luer Cánula traqueal, Standard, fig. 2
- KL 200/08 1 Luer Cánula traqueal, Standard, fig. 4
- 1 Cepillo de limpieza

composto da:

- 1 scatola in metallo
- AD 010/04 1 Manico di bisturi con 1 lama fig. 20
- AD 010/04 1 Manico di bisturi con 1 lama fig. 23
- AB 050/13 1 Pinza per dissezione, 13,0 cm
- AB 060/13 2 Pinze per dissezione, 13,0 cm, 1:2
- AA 214/13 2 Pinze emostatiche Pean, 13,0 cm
- AL 015/13 1 Sonda scanalata, 13,0 cm
- KL 159/07 1 Dilatatore traqueale Bose
- KL 167/02 2 Uncini traqueali Iterson, smussi
- KL 166/01 1 Uncino traqueale Bose, acuto, sinistro
- KL 166/02 1 Uncino traqueale Bose, acuto, destro
- KL 200/07 1 Luer Cannula traqueale Standard, fig. 2
- KL 200/08 1 Luer Cannula traqueale Standard, fig. 4
- 1 Spazzolino per pulire

consisting of:

- 1 Metal case
- AD 010/04 1 Handle with 1 blade Fig. 20
- AD 010/04 1 Handle with 1 blade Fig. 23
- AB 050/13 1 Dressing Forceps 13,0 cm
- AB 060/13 2 Tissue Forceps 13,0 cm
- AA 214/13 2 Pean Artery Forceps 13,0 cm
- AL 015/13 1 Grooved Director 13,0 cm
- KL 159/07 1 Trachea Dilator Bose
- KL 167/02 2 Trachea Retractors, Iterson, blunt
- KL 166/01 1 Trachea Retractor, Bose, sharp, left
- KL 166/02 1 Trachea Retractor, Bose, sharp, right
- KL 200/07 1 Luer Trachea Tube Standard, Fig. 2
- KL 200/08 1 Luer Trachea Tube Standard, Fig. 4
- 1 Clearing Brush

composé de:

- 1 boîte métal
- AD 010/04 1 Manche de bistouri et 1 lame fig. 20
- AD 010/04 1 Manche de bistouri et 1 lame fig. 23
- AB 050/13 1 Pince à dissection, 13,0 cms
- AB 060/13 2 Pinces à griffes, 13,0 cms
- AA 214/13 2 Pinces hémostatiques Pean, 13,0 cms
- AL 015/13 1 Sonde cannelée, 13,0 cms
- KL 159/07 1 Dilatateur trachéal Bose
- KL 167/02 2 Erignes trachéales Iterson, mousses
- KL 166/01 1 Erigne trachéale Bose, pointue, à gauche
- KL 166/02 1 Erigne trachéale Bose, pointue, à droite
- KL 200/07 1 Luer Canule trachéale Standard, fig. 2
- KL 200/08 1 Luer Canule trachéale Standard, fig. 4
- 1 Brosse à nettoyer

AA
 AB
 AC
 AD
 AE
 AF
 AG
 AH
 AI
 AJ
 AK
 AL
 AM
 AN
 AO
 AP
 AQ
 AR
 AS
 AT
 AU
 AV
 AW
 AX
 AY
 AZ
 BA
 BB
 BC
 BD
 BE
 BF
 BG
 BH
 BI
 BJ
 BK
 BL
 BM
 BN
 BO
 BP
 BQ
 BR
 BS
 BT
 BU
 BV
 BW
 BX
 BY
 BZ
 CA
 CB
 CC
 CD
 CE
 CF
 CG
 CH
 CI
 CJ
 CK
 CL
 CM
 CN
 CO
 CP
 CQ
 CR
 CS
 CT
 CU
 CV
 CW
 CX
 CY
 CZ
 DA
 DB
 DC
 DD
 DE
 DF
 DG
 DH
 DI
 DJ
 DK
 DL
 DM
 DN
 DO
 DP
 DQ
 DR
 DS
 DT
 DU
 DV
 DW
 DX
 DY
 DZ
 EA
 EB
 EC
 ED
 EE
 EF
 EG
 EH
 EI
 EJ
 EK
 EL
 EM
 EN
 EO
 EP
 EQ
 ER
 ES
 ET
 EU
 EV
 EW
 EX
 EY
 EZ
 FA
 FB
 FC
 FD
 FE
 FF
 FG
 FH
 FI
 FJ
 FK
 FL
 FM
 FN
 FO
 FP
 FQ
 FR
 FS
 FT
 FU
 FV
 FW
 FX
 FY
 FZ
 GA
 GB
 GC
 GD
 GE
 GF
 GG
 GH
 GI
 GJ
 GK
 GL
 GM
 GN
 GO
 GP
 GQ
 GR
 GS
 GT
 GU
 GV
 GW
 GX
 GY
 GZ
 HA
 HB
 HC
 HD
 HE
 HF
 HG
 HH
 HI
 HJ
 HK
 HL
 HM
 HN
 HO
 HP
 HQ
 HR
 HS
 HT
 HU
 HV
 HW
 HX
 HY
 HZ
 IA
 IB
 IC
 ID
 IE
 IF
 IG
 IH
 II
 IJ
 IK
 IL
 IM
 IN
 IO
 IP
 IQ
 IR
 IS
 IT
 IU
 IV
 IW
 IX
 IY
 IZ
 JA
 JB
 JC
 JD
 JE
 JF
 JG
 JH
 JI
 JJ
 JK
 JL
 JM
 JN
 JO
 JP
 JQ
 JR
 JS
 JT
 JU
 JV
 JW
 JX
 JY
 JZ
 KA
 KB
 KC
 KD
 KE
 KF
 KG
 KH
 KI
 KJ
 KK
 KL
 KM
 KN
 KO
 KP
 KQ
 KR
 KS
 KT
 KU
 KV
 KW
 KX
 KY
 KZ
 LA
 LB
 LC
 LD
 LE
 LF
 LG
 LH
 LI
 LJ
 LK
 LL
 LM
 LN
 LO
 LP
 LQ
 LR
 LS
 LT
 LU
 LV
 LW
 LX
 LY
 LZ
 MA
 MB
 MC
 MD
 ME
 MF
 MG
 MH
 MI
 MJ
 MK
 ML
 MM
 MN
 MO
 MP
 MQ
 MR
 MS
 MT
 MU
 MV
 MW
 MX
 MY
 MZ
 NA
 NB
 NC
 ND
 NE
 NF
 NG
 NH
 NI
 NJ
 NK
 NL
 NM
 NN
 NO
 NP
 NQ
 NR
 NS
 NT
 NU
 NV
 NW
 NX
 NY
 NZ
 OA
 OB
 OC
 OD
 OE
 OF
 OG
 OH
 OI
 OJ
 OK
 OL
 OM
 ON
 OO
 OP
 OQ
 OR
 OS
 OT
 OU
 OV
 OW
 OX
 OY
 OZ
 PA
 PB
 PC
 PD
 PE
 PF
 PG
 PH
 PI
 PJ
 PK
 PL
 PM
 PN
 PO
 PP
 PQ
 PR
 PS
 PT
 PU
 PV
 PW
 PX
 PY
 PZ
 QA
 QB
 QC
 QD
 QE
 QF
 QG
 QH
 QI
 QJ
 QK
 QL
 QM
 QN
 QO
 QP
 QQ
 QR
 QS
 QT
 QU
 QV
 QW
 QX
 QY
 QZ
 RA
 RB
 RC
 RD
 RE
 RF
 RG
 RH
 RI
 RJ
 RK
 RL
 RM
 RN
 RO
 RP
 RQ
 RR
 RS
 RT
 RU
 RV
 RW
 RX
 RY
 RZ
 SA
 SB
 SC
 SD
 SE
 SF
 SG
 SH
 SI
 SJ
 SK
 SL
 SM
 SN
 SO
 SP
 SQ
 SR
 SS
 ST
 SU
 SV
 SW
 SX
 SY
 SZ
 TA
 TB
 TC
 TD
 TE
 TF
 TG
 TH
 TI
 TJ
 TK
 TL
 TM
 TN
 TO
 TP
 TQ
 TR
 TS
 TT
 TU
 TV
 TW
 TX
 TY
 TZ
 UA
 UB
 UC
 UD
 UE
 UF
 UG
 UH
 UI
 UJ
 UK
 UL
 UM
 UN
 UO
 UP
 UQ
 UR
 US
 UT
 UY
 UZ
 VA
 VB
 VC
 VD
 VE
 VF
 VG
 VH
 VI
 VJ
 VK
 VL
 VM
 VN
 VO
 VP
 VQ
 VR
 VS
 VT
 VU
 VV
 VW
 VX
 VY
 VZ
 WA
 WB
 WC
 WD
 WE
 WF
 WG
 WH
 WI
 WJ
 WK
 WL
 WM
 WN
 WO
 WP
 WQ
 WR
 WS
 WT
 WU
 WV
 WW
 WX
 WY
 WZ
 XA
 XB
 XC
 XD
 XE
 XF
 XG
 XH
 XI
 XJ
 XK
 XL
 XM
 XN
 XO
 XP
 XQ
 XR
 XS
 XT
 XU
 XV
 XW
 XX
 XY
 XZ
 YA
 YB
 YC
 YD
 YE
 YF
 YG
 YH
 YI
 YJ
 YK
 YL
 YM
 YN
 YO
 YP
 YQ
 YR
 YS
 YT
 YU
 YV
 YW
 YX
 YZ
 ZA
 ZB
 ZC
 ZD
 ZE
 ZF
 ZG
 ZH
 ZI
 ZJ
 ZK
 ZL
 ZM
 ZN
 ZO
 ZP
 ZQ
 ZR
 ZS
 ZT
 ZU
 ZV
 ZW
 ZX
 ZY
 ZZ

KL KROPF GOITRE BOCIO GOITRE GOZZO

Sonden, Fasszangen, Muskelklemme
 Directors, Seizing Forceps, Muscular Clamp
 Sondas, Pinzas para el bocio, Pinza para músculos
 Sondes, Pince à goitre, Pince musculaire
 Sonde, Pinze per gozzo, Pinza muscolare



KOCHER

15,0 cm/6"
 16,0 cm/6 1/4"
 18,0 cm/7"

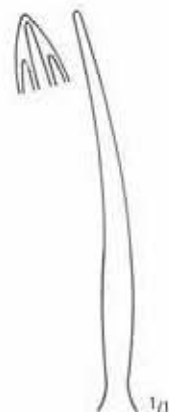

KL 240/15
 KL 240/16

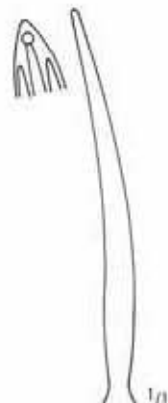

KL 241/15
 KL 241/16

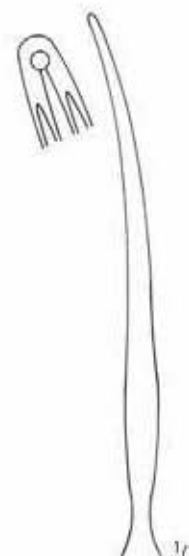

KL 242/18



LAHEY

KL 244/15
 15,0 cm/6"



KL 244/20
 20,0 cm/8"

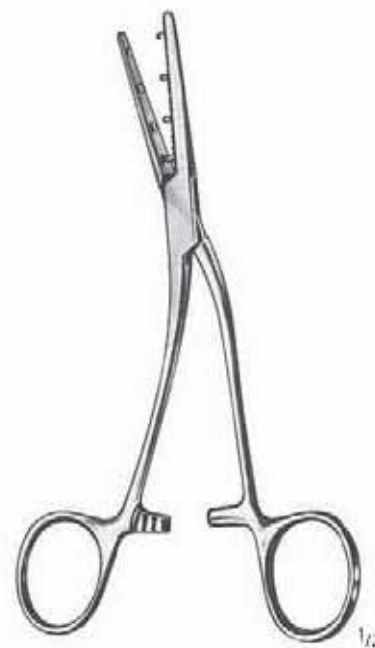

MASTIN

KL 245/17
 17,0 cm/6 3/4"

TONSILLEN TONSILS AMIGDALAS AMYGDALES TONSILLE

Tonsillennmesser
Tonsil Knives
Bisturfes para amígdalas
Bistouris pour amygdales
Bisturi per tonsille

FISCHER
KL 247/22
22,5 cm/9"



ABRAHAM
KL 248/19
19,0 cm/7 1/2"



ABRAHAM
KL 248/21
21,0 cm/8 1/4"



CANFIELD
KL 249/21
21,0 cm/8 1/4"



BRUENINGS
KL 250/23
23,0 cm/9"

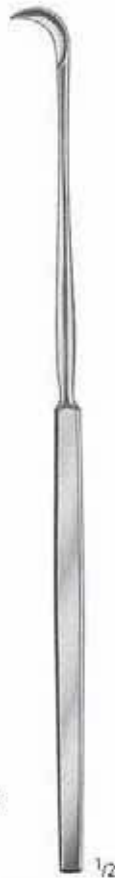

DOUGLAS
KL 251/21
21,0 cm/8 1/4"



AA
AB
AC
AD
AE
AF
AK
AL
AO
AP
AR
KA
KL
KM
KO
KU
KYE
X

KL TONSILLEN TONSILS AMIGDALAS AMYGDALES TONSILLE

Dissektoren
Dissectors
Dissecadores
Dissecteurs
Dissettori

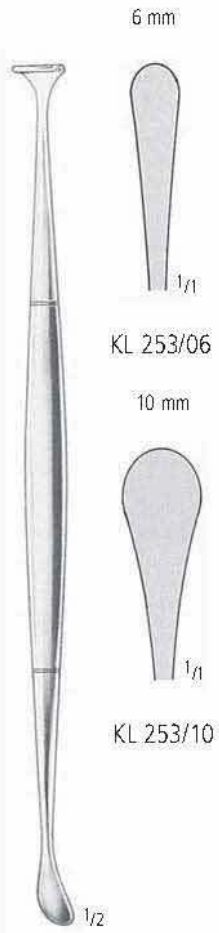

HURD
22,5 cm/9"

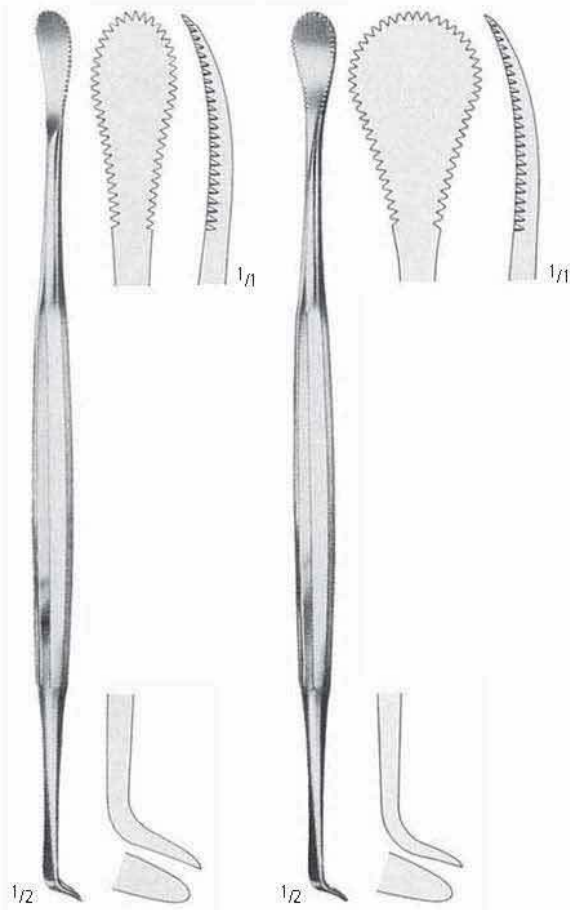

HENKE
KL 255/23
23,0 cm/9"

HENKE
KL 256/23
23,0 cm/9"



LUNIATSCHECK
KL 262/19
19,0 cm/7 1/2"



LOPEZ-REINKE
KL 264/23
23,5 cm/9 1/3"



RÖDER
KL 266/26
26,5 cm/10¹/₂"



HOFER
KL 268/24
24,0 cm/9¹/₂"



NAGER
KL 269/23
23,0 cm/9"



LOVE
18 mm KL 270/18
20 mm KL 270/20
22 mm KL 270/22



HASLINGER
KL 272/17
17,0 cm/6³/₄"

KL TONSILLEN TONSILS AMIGDALAS AMYGDALES TONSILLE

Tonsillenzangen
Tonsil Forceps
Pinzas para las amígdalas
Pincès pour amygdales
Pinze per tonsille



WHITE
KL 276/18 KL 276/23
18,0 cm/7" 23,0 cm/9"

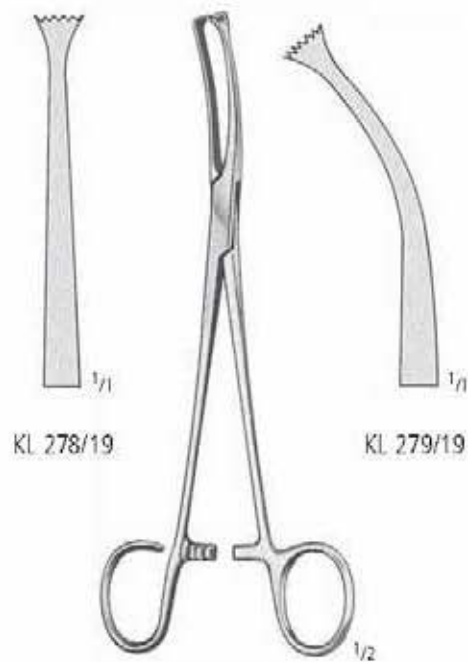

KL 278/19 KL 279/19
COLVER
19,0 cm/7 1/2"



MUSEUX
KL 280/20
20,0 cm/8"



BLOHMKE
KL 281/20
20,0 cm/8"

TONSILLEN TONSILS AMIGDALAS AMYGDALES TONSILLE

Tonsillotom
Tonsillectome
Amigdalótomo
Amygdalotome
Tonsillotomo



KL 291/01

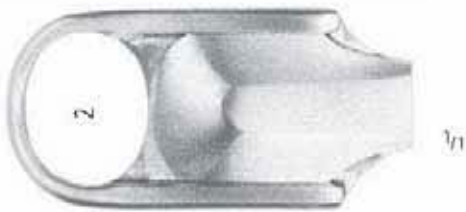

KL 291/02



KL 291/03



KL 290/00
Griff allein
Handle only
Mango suelto
Manche seul
Manico solo

SLUDER-BALLENGER

KL 290/03
komplett mit 3 Aufsätzen
complete with 3 tips
completo con 3 puntas
complet avec 3 lames
completo di 3 lame



CORWIN
KL 291/14
14,0 cm/5 1/2"

AA
AB
AC
AD
AE
AF
AK
AL
AO
AP
AR
KA
KL
KM
KO
KU
KYE
X

KL TONSILLEN TONSILS AMIGDALAS AMYGDALES TONSILLE

Tonsillenschnürer
Tonsil Snares
Cierra-nudos para amígdalas
Serre-noeuds pour l'ablation des amygdales
Serranodí per tonsille

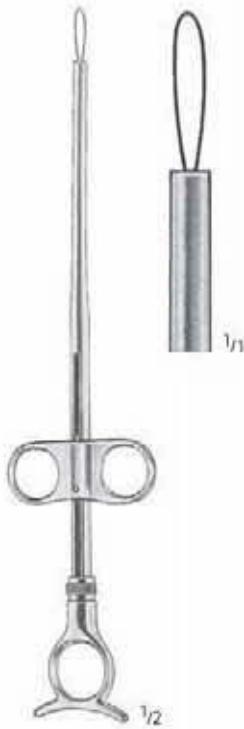

EVES
KL 300/28
28,0 cm/11"



EVES
KL 302/28
28,0 cm/11"



**BRUE-
NINGSKL**
306/28



Packung 100 Stück
Pack of 100 pcs.
Paquete de 100 unidades
en paquets de 100 pièces
pacco di 100 pezzi

KL 310/40 = 40 mm
KL 310/50 = 50 mm



Packung 12 Stück
Pack of 12 pcs.
Paquete de 12 unidades
en paquets de 12 pièces
pacco di 12 pezzi

KL 311/03 = 0,3 mm

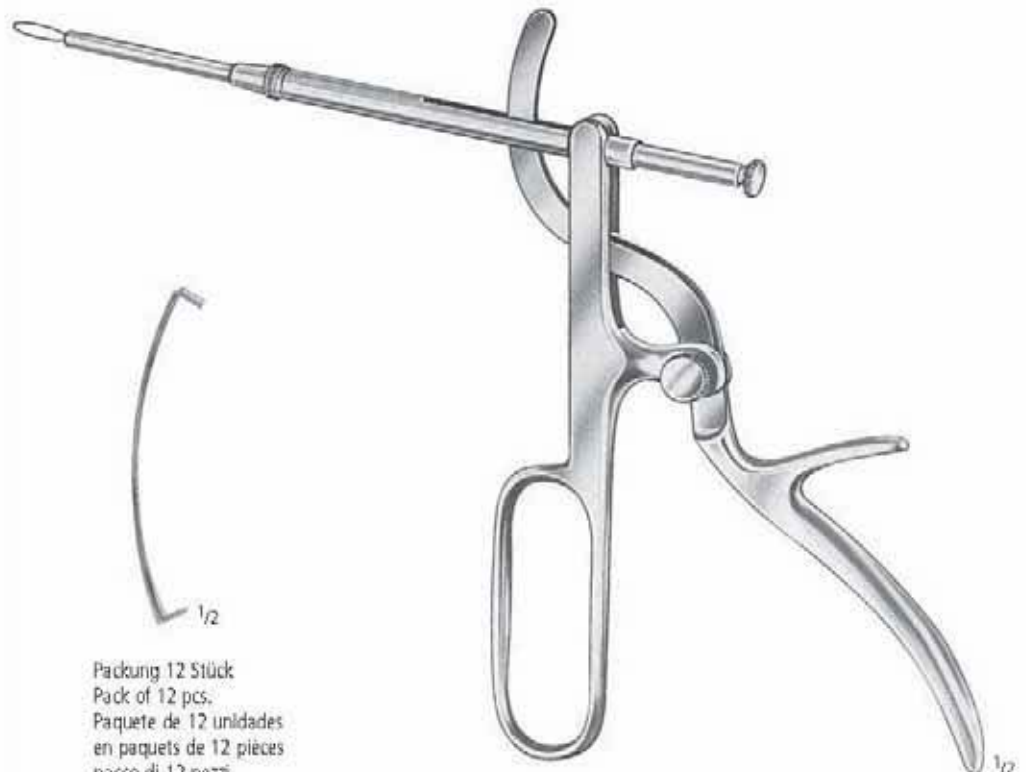

TYDING
KL 314/01

TONSILLEN TONSILS AMIGDALAS AMYGALES TONSILLE

Scharfe Tonsillenzangen
Tonsil Punches
Pinzas cortantes para amígdalas
Pincès emporte-pièces pour amygdales
Pinze tagliente per tonsille

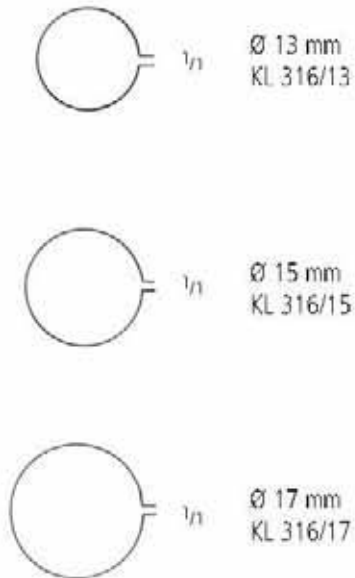

HARTMANN



SCHMEDEN

AA
AB
AC
AD
AE
AF
AK
AL
AO
AP
AR
KA
KL
KM
KO
KU
KYE
X

Laryngo-Zangen
Laryngeal forceps
Pinzas para Laringología
Pinces pour Laryngologie
Pinze per Laringologia

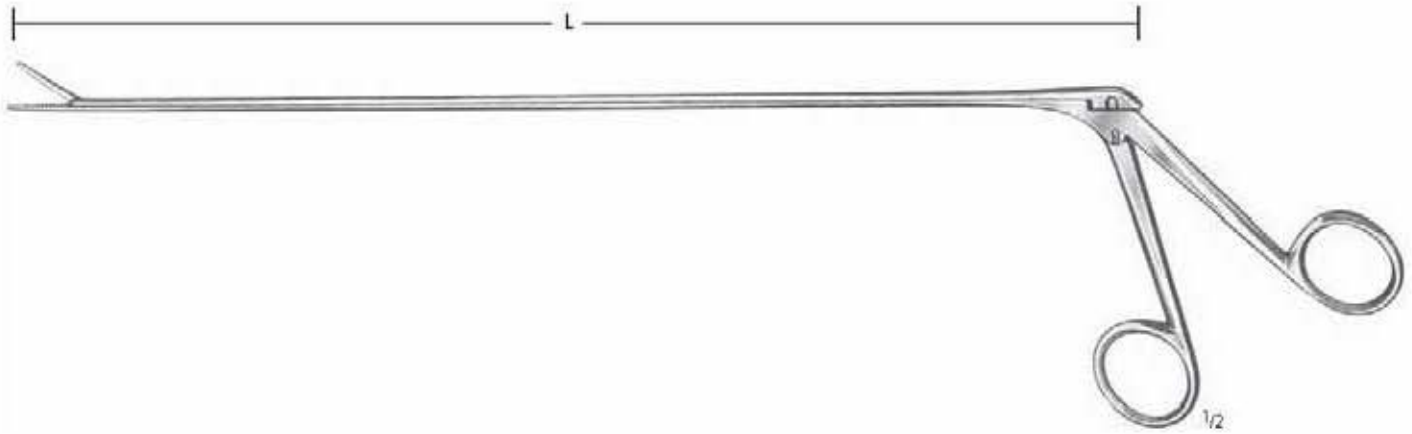

CHEVALIER-JACKSON



L
30 cm/12"
40 cm/16"
50 cm/20"
60 cm/24"

KL 321/30
KL 321/40
KL 321/50
KL 321/60

KL 322/30
KL 322/40
KL 322/50
KL 322/60

KL 323/30
KL 323/40
KL 323/50
KL 323/60

KL 324/30
KL 324/40
KL 324/50
KL 324/60



L
30 cm/12"
40 cm/16"
50 cm/20"
60 cm/24"

KL 325/30
KL 325/40
KL 325/50
KL 325/60

KL 326/30
KL 326/40
KL 326/50
KL 326/60

KL 327/30
KL 327/40
KL 327/50
KL 327/60

KL 328/30
KL 328/40
KL 328/50
KL 328/60



L
30 cm/12"
40 cm/16"
50 cm/20"
60 cm/24"

KL 329/30
KL 329/40
KL 329/50
KL 329/60

KL 330/30
KL 330/40
KL 330/50
KL 330/60

KL 331/30
KL 331/40
KL 331/50
KL 331/60

Universalgriffe und Aufsätze
 Universal handles and tips
 Mangos universales y pinzas intercambiables
 Manches universels et pinces interchangeables
 Manici universali e pinze intercambiabili



HUBER
 KL 360/00



BRUENINGS

- | | |
|-------------|-----------|
| 20,0 cm/8" | KL 364/20 |
| 30,0 cm/12" | KL 364/30 |
| 40,0 cm/16" | KL 364/40 |
| 50,0 cm/20" | KL 364/50 |
| 60,0 cm/24" | KL 364/60 |



BRUENINGS
 20,0 cm/8"

KL 365/20

KL 366/20

starr
 rigid
 rígida
 rigide
 rigida

biegsam
 malleable
 flexible
 flexible
 flessibile

AA
 AB
 AC
 AD
 AE
 AF
 AK
 AL
 AO
 AP
 AR
 KA
KL
 KM
 KO
 KU
 KYE
 X

Universalgriffe und Aufsätze
 Universal handles and tips
 Mangos universales y pinzas intercambiables
 Manches universels et pinces interchangeables
 Manici universali e pinze intercambiabili



FRAENKEL

KL 400/00



SEIFFERT

KL 402/00



FRAENKEL

KL 403/00



SCHEINMANN

KL 404/00



SCHEINMANN



KL 405/00



BRUENINGS



KL 406/02



KL 406/03



KL 406/04



BRUENINGS



KL 407/00



KL 407/01

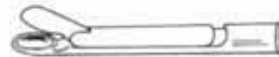

LANGE

KL 408/00



KRAUSE



KL 409/00



KL 409/01



KRAUSE



KL 410/00



CORDES

KL 411/01



KL 411/02



KL 411/03



KL 411/04



SCHUMACHER



KL 412/00



CORDES



KL 413/01



KL 413/02

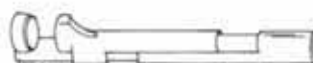

CORDES



KL 414/00



ROSENBERG

KL 415/00

Endolaryngeale Mikrochirurgie
 Endolaryngeal Micro-Surgery
 Microcirugía Endolaringea
 Endolaryngeal micro-chirurgie
 Microchirurgia Endolaringea

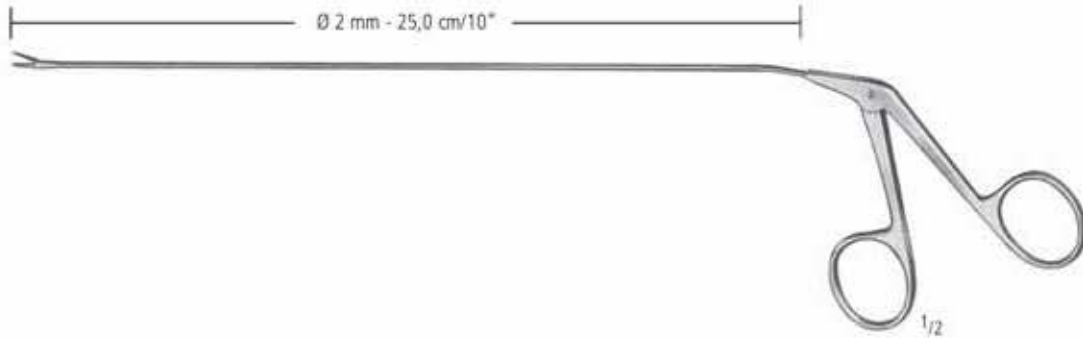

- | | |
|--|--|
| | KL 440/00
gerade - straight - rectas - droits - rette |
| | KL 440/01
aufgebogen - curved up - curvo arriba - courbe vers le haut - curva in alto |
| | KL 440/02
rechts - right - a la derecha - à droite - a destra |
| | KL 440/03
links - left - a la izquierda - à gauche - a sinistra |
| | KL 441/00
gerade - straight - rectas - droits - rette |
| | KL 441/01
rechts - right - a la derecha - à droite - a destra |
| | KL 441/02
links - left - a la izquierda - à gauche - a sinistra |
| | KL 443/00
gerade - straight - rectas - droits - rette |
| | KL 443/01
aufgebogen - curved up - curvo arriba - courbe vers le haut - curva in alto |
| | KL 443/02
rechts - right - a la derecha - à droite - a destra |
| | KL 443/04
links - left - a la izquierda - à gauche - a sinistra |

AA
AB
AC
AD
AE
AF
AK
AL
AO
AP
AR
KA
KL
KM
KO
KU
KYE
X

Zangen zur Laryngo-Bronchoskopie
 Forceps for Laryngo-Bronchoscopy
 Pinzas para Laringo-Broncoscopia
 Pincas pour Laryngo-Bronchoscopie
 Pinze per Laringo-Broncoscopia



Ø 1,5 mm



L
 30,0 cm/12"
 35,0 cm/14"

KL 460/30
 KL 460/35

KL 461/30
 KL 461/35

KL 462/30
 KL 462/35

KL 463/30
 KL 463/35

Ø 2,5 mm



L
 40,0 cm/16"
 45,0 cm/18"
 50,0 cm/20"
 55,0 cm/22"
 60,0 cm/24"

KL 460/40
 KL 460/45
 KL 460/50
 KL 460/55
 KL 460/60

KL 461/40
 KL 461/45
 KL 461/50
 KL 461/55
 KL 461/60

KL 462/40
 KL 462/45
 KL 462/50
 KL 462/55
 KL 462/60

KL 463/40
 KL 463/45
 KL 463/50
 KL 463/55
 KL 463/60

Kehlkopfspiegel
Laryngeal Mirrors
Espejos laringeos
Miroirs laryngiens
Specchi laringei



Fig. 00



Fig. 0



Fig. 1

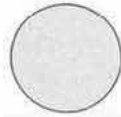

Fig. 2



Fig. 3

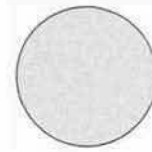

Fig. 4

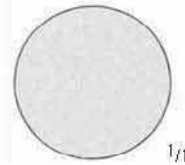

Fig. 5

1/11



Fig. 6



Fig. 7

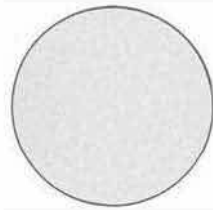

Fig. 8

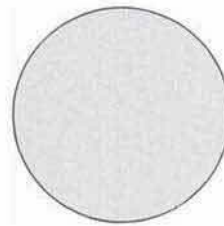

Fig. 9

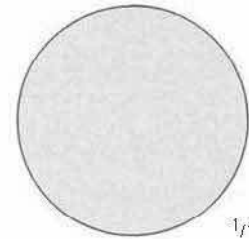

Fig. 10

1/11



KL 500/10



- KL 520/08
- KL 520/10
- KL 520/12
- KL 520/14
- KL 520/16
- KL 520/18
- KL 520/20
- KL 520/22
- KL 520/24
- KL 520/26
- KL 520/28
- KL 520/30

Fig.	mm Ø
00	8
0	10
1	12
2	14
3	16
4	18
5	20
6	22
7	24
8	26
9	28
10	30



- KL 522/08
- KL 522/10
- KL 522/12
- KL 522/14
- KL 522/16
- KL 522/18
- KL 522/20
- KL 522/22
- KL 522/24
- KL 522/26
- KL 522/28
- KL 522/30



- MICHEL**
- KL 524/12
 - KL 524/14
 - KL 524/16
 - KL 524/18

AA
AB
AC
AD
AE
AF
AK
AL
AO
AP
AR
KA
KL
KM
KO
KU
KYE
X



REICHERT
KL 590/24
24,0 cm/9½"



KILLIAN
KL 594/20
20,0 cm/8"

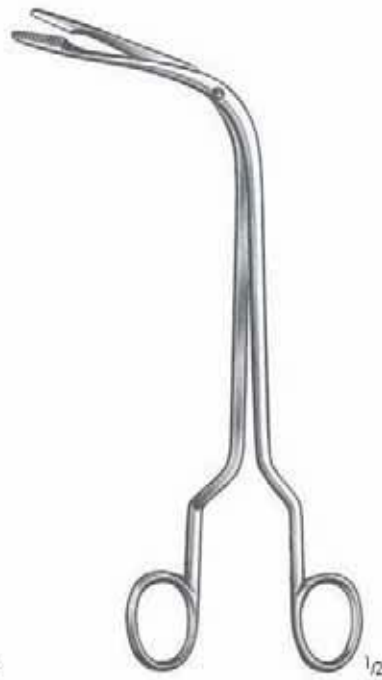

FRAENKEL
KL 601/18
18,0 cm/7"



FRAENKEL
KL 603/19
19,0 cm/7½"

Kehlkopfpolypenzangen
 Laryngeal Polypus Forceps
 Pinzas para pólipos laríngeos
 Pincas à polypes laryngiens
 Pinze per polipi laringei



FRAENKEL
 KL 613/00
 26,5 cm/10¹/₂"



LANGE
 KL 614/00
 26,5 cm/10¹/₂"

AA
 AB
 AC
 AD
 AE
 AF
 AK
 AL
 AO
 AP
 AR
 KA
KL
 KM
 KO
 KU
 KYE
 X



JAKO
30,0 cm/12"



KL 660/00
Griff allein
Handle only
Mango suelto
Manche seul
Manico solo



KLEINSASSER
23,0 cm/9"



HEERMANN
KL 670/00

HNO
ENT
ORL

KM

nopa[®] instruments

Otologie
Otology
Otologia
Otologie
Otologia

Seite 297-328
Page 297-328
Página 297-328
Page 297-328
Pagina 297-328



KM OHR OTOTOLOGY OTOLOGIA OTOLOGIE OTOLOGIA

Ohrspekula
Ear Specula
Espéculos auriculares
Spéculums auriculaires
Specoli auricolari

∅ = Innendurchmesser
inside diameter
diámetro interior
diamètre intérieur
diámetro interno

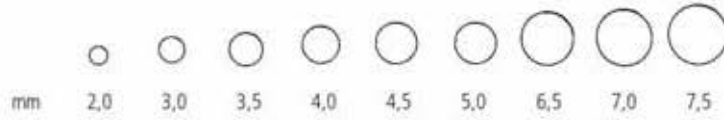

KM 020/03
Set 1 - 3



für Kinder
for children
para niños
pour enfants
per bambini
KM 030/03
Set 0 - 2



für Erwachsene
for adults
para adultos
pour adultes
per adulti
KM 040/03
Set 2 - 4
KM 040/04
Set 1 - 4

	POLITZER	HARTMANN	HARTMANN
mm			
2,0	KM 021/01	KM 031/00	
3,0	KM 021/02		
3,5		KM 031/01	KM 031/01
4,0	KM 021/03		
5,0	KM 021/04	KM 031/02	KM 031/02
6,5			KM 031/03
7,5			KM 031/04



schwarz
black
negro
noir
nero
KM 042/04
Set 0 - 3



KM 044/03
Set 2 - 4
KM 044/04
Set 1 - 4



KM 050/04
Set 1 - 4

	HARTMANN	TOYNBEE	GRUBER
mm			
3,0	KM 041/00	KM 045/01	
4,0	KM 041/01	KM 045/02	
4,5			KM 051/01
5,0	KM 041/02	KM 045/03	
5,5			KM 051/02
6,5		KM 045/04	KM 051/03
7,0	KM 041/03		KM 051/04







OHR OTOLOGY OTOLOGIA OTOLOGIE OTOLOGIA

Ohrspekula
Ear Specula
Espéculos auriculares
Spéculums auriculaires
Specoli auricolari

Alu schwarz
Alu black
Aluminio negro
Aluminium noir
Alluminio nero



ZÖLLNER
KM 054/00
Set 1 - 6

-  KM 054/01
5,5 x 6,5 mm
-  KM 054/02
6,5 x 7,5 mm
-  KM 054/03
7,5 x 8,5 mm
-  KM 054/04
8,5 x 9,5 mm
-  KM 054/05
9,5 x 10,5 mm
-  KM 054/06
10,5 x 11,5 mm























BOUCHERON
KM 056/00
Set 1 - 4

-  KM 056/01
3,5 mm
-  KM 056/02
4,5 mm
-  KM 056/03
5,5 mm
-  KM 056/04
6,5 mm



FARRIOR

- | | | | | | | | | |
|---|--------|-----------|---|--------------|-----------|---|-----------|-----------|
|  | 3,3 mm | KM 060/33 |  | 3,0 x 4,0 mm | KM 062/30 |  | KM 063/30 | KM 064/30 |
|  | 4,3 mm | KM 060/43 |  | 4,0 x 5,0 mm | KM 062/40 |  | KM 063/40 | KM 064/40 |
|  | 4,8 mm | KM 060/48 |  | 4,5 x 5,5 mm | KM 062/45 |  | KM 063/45 | KM 064/45 |
|  | 5,3 mm | KM 060/53 |  | 5,0 x 6,0 mm | KM 062/50 | | KM 063/50 | KM 064/50 |
|  | 5,8 mm | KM 060/58 |  | 5,5 x 6,5 mm | KM 062/55 | | KM 063/55 | KM 064/55 |
|  | 6,3 mm | KM 060/63 |  | 6,0 x 7,0 mm | KM 062/60 | | KM 063/60 | KM 064/60 |
|  | 6,7 mm | KM 060/67 |  | 6,5 x 7,5 mm | KM 062/65 | | KM 063/65 | KM 064/65 |
|  | 7,2 mm | KM 060/72 |  | 7,0 x 8,0 mm | KM 062/70 | | KM 063/70 | KM 064/70 |
|  | 7,7 mm | KM 060/77 |  | 7,5 x 8,5 mm | KM 062/75 | | KM 063/75 | KM 064/75 |

20°

35°

AA
AB
AC
AD
AE
AF
AK
AL
AO
AP
AR
KA
KL
KM
KO
KU
KYE
X

Ohrspekula
 Ear Specula
 Espéculos auriculares
 Spéculums auriculaires
 Specoli auricolari



BRUENINGS

KM 080/00

komplett mit 4 Spekula Fig. 0 - 3
 complete with 4 specula fig. 0 - 3
 completo con 4 espéculos fig. 0 - 3
 complet avec 4 spéculums fig. 0 - 3
 completo con 4 specoli fig. 0 - 3

	Fig. 00	KM 081/01	
		2,0/4,0 mm	
	0	KM 081/02	
		3,0/4,8 mm	
	1	KM 082/01	
		4,0/6,0 mm	
	2	KM 082/02	KM 084/01
		5,0/7,0 mm	Saugkammer, allein Suction Head, only
	3	KM 082/03	Cámara de aspiración, suelto Chambre aspiratrice, seule
		6,5/8,5 mm	Camera aspirante, sola
	4	KM 082/04	KM 085/00
		8,5/10,5 mm	Gebläse, allein Rubbertube and bulb, only
	5	KM 082/05	Insuflador de goma, suelto Soufflerie, seule
		10,5/12,5 mm	Soffiera, sola

für 12 Spekula
 for 12 specula
 para 12 espéculos
 pour 12 spéculums
 per 12 specoli

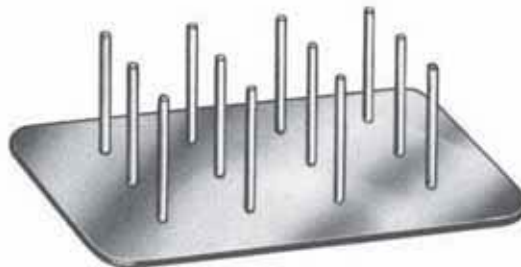

KM 090/12

OHR OTOLGY OTOLOGIA OTOLOGIE OTOLOGIA

Ohrspekula
Ear Specula
Espéculos auriculares
Spéculum auriculaires
Specoli auricolari



SIEGLE

KM 092/00

komplett
complete
completo
complet
completo

5,0/6,0 mm



KM 092/01

6,0/7,0 mm



KM 092/02

7,0/8,0 mm



KM 092/03

KM 092/90

Gebläse, allein
Rubbertube and bulb, only
Insuflador de goma, suelto
Soufflerie, seule
Soffiera, sola



RICHNAU HOLMGREN

Ø 2,0 mm KM 095/02
Ø 4,0 mm KM 095/04
Ø 6,0 mm KM 095/06

AA
AB
AC
AD
AE
AF
AK
AL
AO
AP
AR
KA
KL
KM
KO
KU
KYE
X

Polypenschnürer
 Polypus Snares
 Polipótomos
 Serre-nœuds
 Serranodi



KRAUSE
 KM 100/00
 16,0 cm/6 1/4"



KRAUSE-VOSS
 KM 110/00
 16,0 cm/6 1/4"



LANGE-WILDE
 KM 115/00
 16,0 cm/6 1/4"



10 m/33 ft.
 KM 128/03 = 0,3 mm
 KM 128/04 = 0,4 mm



Packung 12 Stück
 Pack. of 12 pcs.
 Paquete de 12 unidades
 en paquets de 12 pièces
 pacco di 12 pezzi

KM 130/02 = 0,2 mm
 KM 130/03 = 0,3 mm

Packung 100 Stück
 Pack. of 100 pcs.
 Paquete de 100 unidades
 en paquets de 100 pièces
 pacco di 100 pezzi

KM 132/02 = 0,2 mm
 KM 132/03 = 0,3 mm

OHR OTOLGY OTOLOGIA OTOLOGIE OTOLOGIA

Ohrzängchen
 Ear Forceps
 Pinzas auriculares
 Pincès auriculaires
 Pinze auricolari

AA
 AB
 AC
 AD
 AE
 AF
 AK
 AL
 AO
 AP
 AR
 KA
 KL
KM
 KO
 KU
 KYE
 X

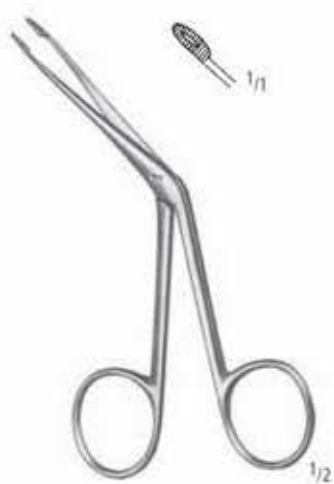

HARTMANN
 KM 200/00
 12,0 cm/4³/₄"



HARTMANN
 KM 200/01
 14,0 cm/5¹/₂"

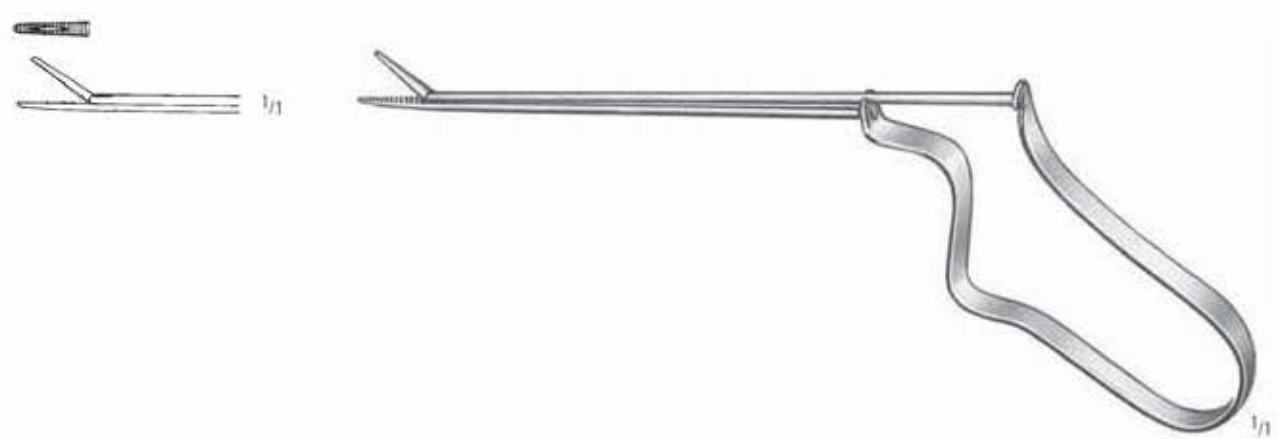

BUCK
 KM 205/00



QUIRE
 KM 207/00

Ohrzängchen
 Ear Forceps
 Pinzas auriculares
 Pincès auriculaires
 Pinze auricolari



HARTMANN-WULLSTEIN
 KM 220/08



HARTMANN-WULLSTEIN
 KM 222/08



DUCKBILL
 KM 233/08



HARTMANN
 KM 226/08 8,5 cm/3 1/3"
 KM 226/14 14,0 cm/5 1/2"



HARTMANN
 KM 228/08
 KM 228/14



HARTMANN-NOYES
 KM 230/08



HARTMANN
 KM 238/20 = 2,0 mm
 KM 238/25 = 2,5 mm
 KM 238/30 = 3,0 mm



WEINGÄRTNER
 KM 234/08



HARTMANN
 KM 240/20 = 2,0 mm
 KM 240/25 = 2,5 mm
 KM 240/30 = 3,0 mm

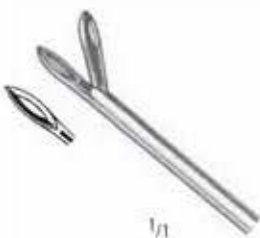

STRÜMPEL
 KM 242/08



HARTMANN
 KM 244/08



HARTMANN
 KM 248/08



HARTMANN-HOFFMANN
 KM 248/20

OHR OTOLGY OTOLOGIA OTOLOGIE OTOLOGIA

Mikro Ohrzangchen
 Micro Ear Forceps
 Micro pinzas auriculares
 Micro pinces auriculaires
 Micro pinze auricolari

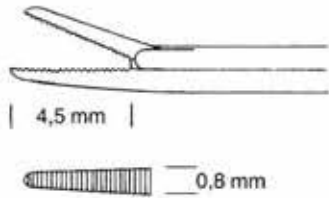

KM 300/08

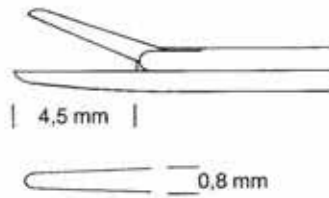

KM 304/08

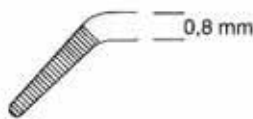

KM 308/08



KM 312/08

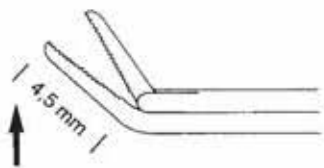

KM 316/08

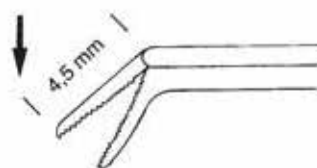

KM 320/08

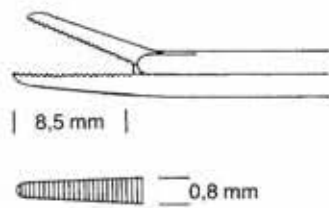

KM 324/08

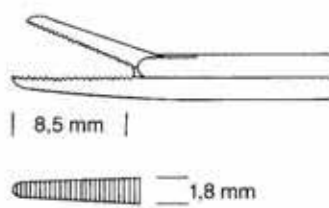

KM 326/08

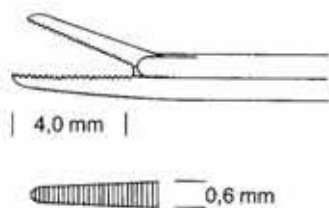

KM 328/08

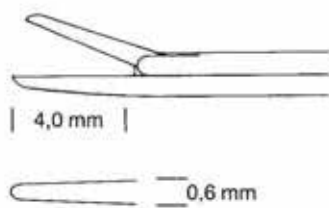

KM 330/08

AA
 AB
 AC
 AD
 AE
 AF
 AK
 AL
 AO
 AP
 AR
 KA
 KL
 KM
 KO
 KU
 KYE
 X

KM OHR OTOTOLOGY OTOLOGIA OTOLOGIE OTOLOGIA

Mikro Ohrzangchen
 Micro Ear Forceps
 Micro pinzas auriculares
 Micro pinces auriculaires
 Micro pinze auricolari



KM 334/08

gerade
 straight
 rectas
 droits
 rette



| 4,0 mm |

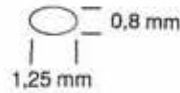

0,8 mm
 1,25 mm



KM 338/08

rechts gebogen
 curved right
 curvas derecha
 courbes  droite
 curva destra

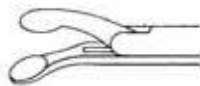

KM 342/08

links gebogen
 curved left
 curvas izquierda
 courbes  gauche
 curva sinistra



KM 346/08

aufgebogen
 curved up
 curvas arriba
 courbes en montant
 curva in alto



KM 350/08

abgebogen
 curved down
 curvas abajo
 courbes en bas
 curva in basso



CRURA-NIPPER
 KM 354/08

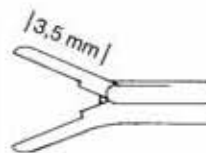

McGEE
 KM 356/08

OHR OTOLGY OTOLOGIA OTOLOGIE OTOLOGIA

Mikro Ohrzangchen
 Micro Ear Forceps
 Micro pinzas auriculares
 Micro pinces auriculaires
 Micro pinze auricolari

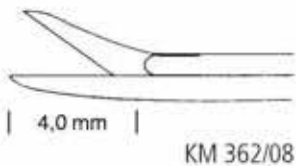

KM 362/08

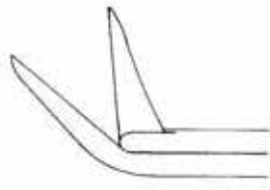

KM 364/08



KM 366/08



KM 370/08



BELLUCCI



KM 376/08

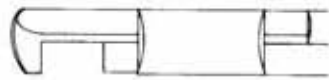

KM 378/08



DIETER

AA
 AB
 AC
 AD
 AE
 AF
 AK
 AL
 AO
 AP
 AR
 KA
 KL
KM
 KO
 KU
 KYE
 X

KM OHR OTOLGY OTOLOGIA OTOLOGIE OTOLOGIA

Mikro Ohrzangchen
 Micro Ear Forceps
 Micro pinzas auriculares
 Micro pinces auriculaires
 Micro pinze auricolari

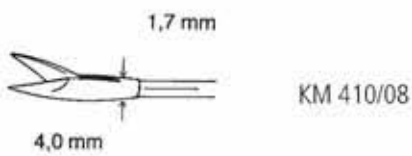
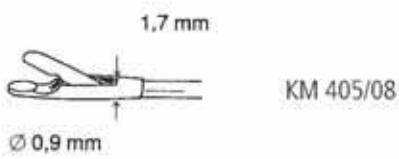
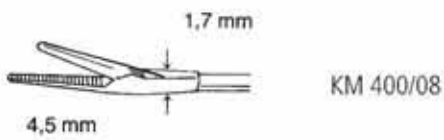
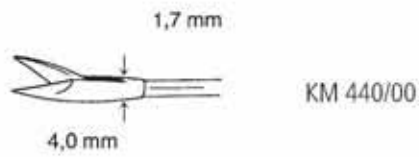
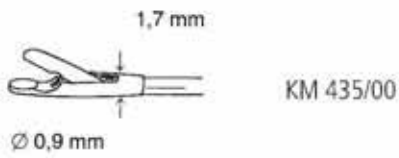
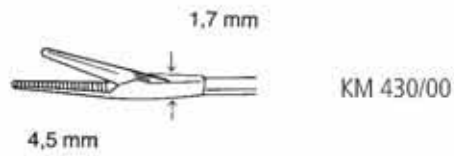

WULLSTEIN



WULLSTEIN

OHR OTOLGY OTOLOGIA OTOLOGIE OTOLOGIA

Stanzen
Punches
Pinzas osteótomas
Pinces ostéotomes
Pinze osteotomi

∩ 1/1 1 mm

∩ 1/1 2 mm

∩ 1/1 3 mm



CITELLI
KM 490/01
KM 490/02
KM 490/03



BEYER
KM 492/19

Weitere Stanzen siehe Gruppen KO und KS.
For further Punches see sections KO and KS.
Para otras pinzas cortantes ver seccion KO y KS.
D'autres pinces coupantes voir groupe KO et KS.
Altre pinze taglienti vedi gruppo KO e KS.

AA
AB
AC
AD
AE
AF
AK
AL
AO
AP
AR
KA
KL
KM
KO
KU
KYE
X

KM OHR OTOTOLOGY OTOLOGIA OTOLOGIE OTOLOGIA

Küretten, Löffel
Curettes, Spoons
Curetas, Cucharillas
Curettes
Curette, Cucchiari

stumpf - blunt - romas - mousses - smusse



KM 520/00

KM 521/00

KM 522/00

KM 522/01

KM 522/02

KM 522/03

KM 522/04

KM 522/05



Fig.000

00

0

1

2

3

4

5

KM 530/00

KM 531/00

KM 532/00

KM 532/01

KM 532/02

KM 532/03

KM 532/04

KM 532/05

scharf - sharp - cortantes - tranchantes - taglienti

BUCK
16,5 cm/6 1/2"



KM 536/01

KM 536/02



SHAPLEIGH
13,0 cm/5"



LANGENBECK
KM 538/13
13,0 cm/5"



BARTH
KM 540/18
18,0 cm/7"



JANSEN
KM 542/15
15,0 cm/6"

OHR OTOLGY OTOLOGIA OTOLOGIE OTOLOGIA

Schlingen, Häkchen
 Loops, Hooklets
 Asas, Ganchitos
 Anses, Crochets
 Anse, Uncini

AA
AB
AC
AD
AE
AF
AK
AL
AO
AP
AR
KA
KL
KM
KO
KU
KYE
X



BILLEAU
 16,5 cm/6 1/2"



SNELLEN
 16,5 cm/6 1/2"



GROSS
 KM 556/12
 12,0 cm/4 3/4"



HARTMANN
 KM 560/16
 16,5 cm/6 1/2"

ZAUFAL
 KM 566/16
 16,5 cm/6 1/2"

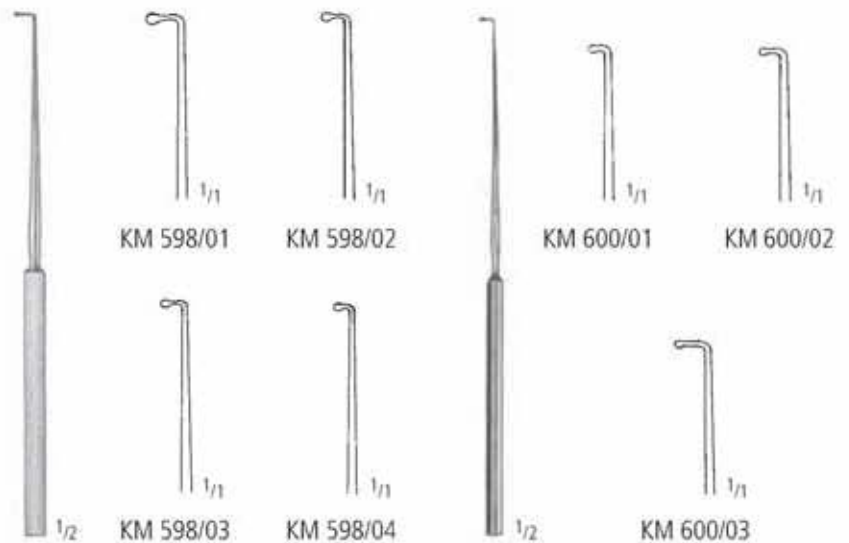

WAGENER
 14,0 cm/5 1/2"

LUCAE
 14,0 cm/5 1/2"

Parazentesnadeln, Messer
 Paracentesis Needles, Knives
 Agujas para paracentesis, Cuchillos
 Aiguilles à paracentèse, Couteaux
 Aghi per paracentesi, Coltelli



POLITZER
 KM 610/16
 16,5 cm/6 1/2"

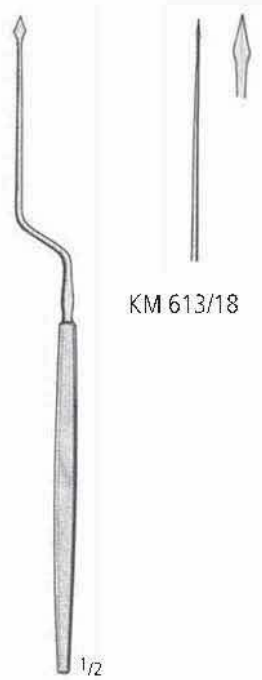

LUCAE
 KM 612/18
 18,5 cm/7 1/3"



POLITZER
 KM 614/17
 17,0 cm/6 3/4"



POLITZER
 KM 616/16
 16,0 cm/6 1/4"

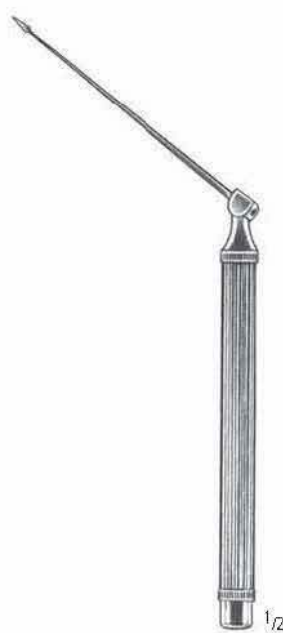

SPRAGUE
 KM 618/00
 komplett
 complete
 completo
 complet
 completo

Ohrbesteck
 Ear Operating Set
 Juegos otológicos
 Trousse auriculaire
 Astucci auricolari



OHR OTOLGY OTOLOGIA OTOLOGIE OTOLOGIA

Nadeln, Häkchen
Needles, Hooklets
Agujas, Ganchos
Aiguilles, Crochets
Aghi, Ganci



BARBARA
25°

- 0,3 mm KM 630/03
- 0,6 mm KM 630/06
- 1,0 mm KM 630/10
- 1,2 mm
- 1,5 mm
- 2,0 mm
- 2,5 mm



SHAMBAUGH
45°

- KM 631/03
- KM 631/06
- KM 631/10
- KM 631/12
- KM 631/15
- KM 631/20
- KM 631/25



SHAMBAUGH
90°

- KM 632/03
- KM 632/06
- KM 632/10
- KM 632/12
- KM 632/15
- KM 632/20
- KM 632/25



BARBARA

- KM 633/06
- KM 633/10



16,0 cm/6 1/4"



BARBARA
KM 634/00



BARBARA
KM 634/01



BARBARA
KM 634/02



ROSEN
KM 634/03

AA
AB
AC
AD
AE
AF
AK
AL
AO
AP
AR
KA
KL
KM
KO
KU
KYE
X

KM OHR OTOTOLOGY OTOLOGIA OTOLOGIE OTOLOGIA

Nadeln, Hakchen
 Needles, Hooklets
 Agujas, Ganchos
 Aiguilles, Crochets
 Aghi, Ganci



0,3 mm KM 638/03
 0,6 mm KM 638/06
 1,0 mm KM 638/10



KM 640/03
 KM 640/06
 KM 640/10



KM 642/03
 KM 642/06
 KM 642/10



0,3 mm KM 639/03
 0,6 mm KM 639/06
 1,0 mm KM 639/10



KM 641/03
 KM 641/06
 KM 641/10



KM 643/03
 KM 643/06
 KM 643/10



McGEE
 0,5 mm KM 646/05
 1,0 mm KM 646/10



McGEE
 KM 647/05
 KM 647/10



BARBARA
 KM 648/00



ROSEN
 KM 648/01

OHR OTOLGY OTOLOGIA OTOLOGIE OTOLOGIA

Messer
Knives
Cuchillos
Couteaux
Coltelli



ROSEN
16,0 cm/6 1/4"

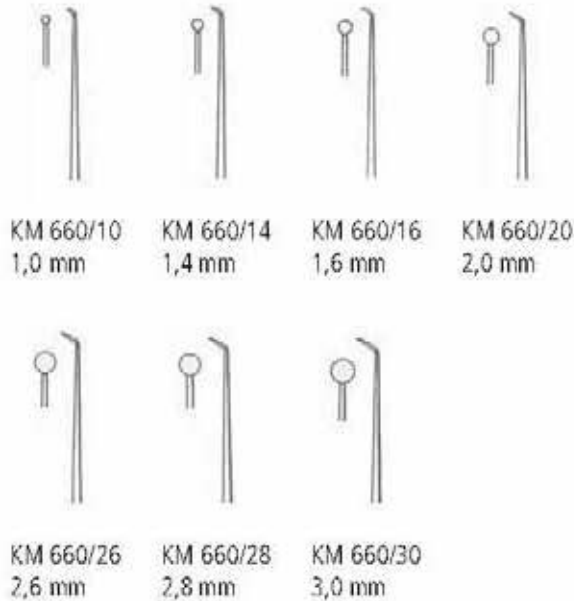

16,0 cm/6 1/4"



SCHUKNECHT
16,0 cm/6 1/4"



WULLSTEIN
KM 669/16
16,0 cm/6 1/4"



SCHUKNECHT
KM 670/16
16,0 cm/6 1/4"

AA
AB
AC
AD
AE
AF
AK
AL
AO
AP
AR
KA
KL
KM
KO
KU
KYE
X

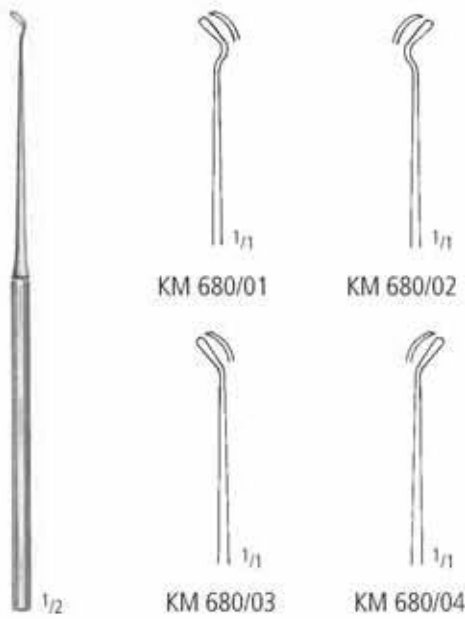

FISCH
16,0 cm/6 1/4"

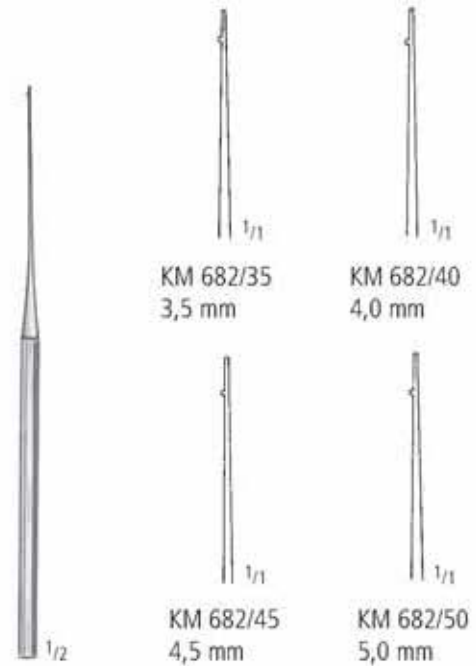

HOUSE
16,0 cm/6 1/4"



ROSEN
19,0 cm/7 1/2"

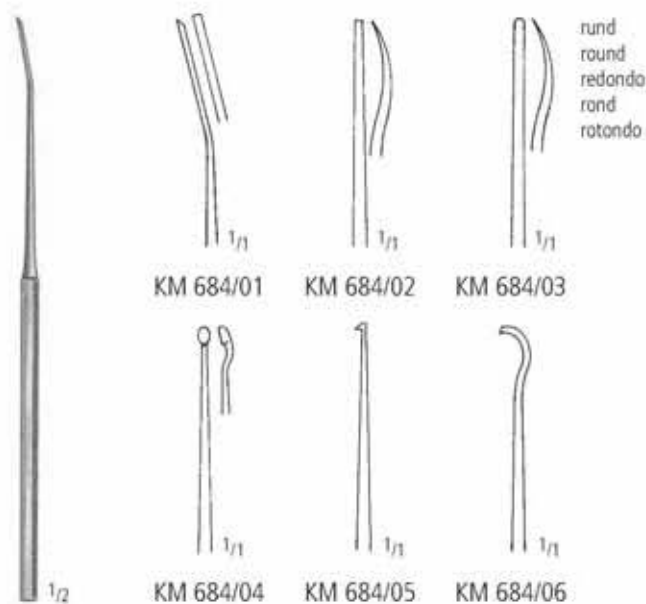

ROSEN
16,0 cm/6 1/4"



PLESTER
KM 685/16
16,0 cm/6 1/4"

OHR OTOLGY OTOLOGIA OTOLOGIE OTOLOGIA

Instrumente für die Stapes-Fußplatte
 Footplate Hand Instruments
 Instrumentos para la platina estapediense
 Instruments pour chirurgie de l'étrier
 Strumenti per lo stapes

AA
AB
AC
AD
AE
AF
AK
AL
AO
AP
AR
KA
KL
KM
KO
KU
KYE
X



HOUSE
 15,0 cm/6"
 KM 703/01 1,0 + 1,2 mm
 KM 703/02 1,5 + 1,8 mm



HOUSE
 15,0 cm/6"
 KM 705/01
 KM 705/02



SHEA
 KM 706/16
 16,0 cm/6 1/4"



SHEA
 KM 707/16
 16,0 cm/6 1/4"



16,0 cm/6 1/4"



BUCKINGHAM
 KM 710/01



BUCKINGHAM
 KM 710/02



BUCKINGHAM
 KM 710/03



LARKIN
 KM 711/01



LARKIN
 KM 711/02



LARKIN
 KM 711/03

Instrumente für die Stapes-Fußplatte
 Footplate Hand Instruments
 Instrumentos para la platina estapediense
 Instruments pour chirurgie de l'étrier
 Strumenti per lo stapes



HEERMANN
 KM 715/00



0,7 mm KM 715/01



0,7 mm KM 715/02



1,0 mm KM 715/03



1,5 mm KM 715/04



3,0 mm KM 715/05



KM 716/00
 19,5 cm/7³/₄"



ZÖLLNER

			KM 720/01				
↓		45°/0,5 mm	KM 720/02	↑		90°	KM 720/10
↓		45°/1,0 mm	KM 720/03	↓		90°	KM 720/11
↑		45°/0,5 mm	KM 720/04	↑			KM 720/12
↑		45°/1,0 mm	KM 720/05	↓			KM 720/13
↑		90°/0,5 mm	KM 720/06	→			KM 720/14
↓		90°/0,5 mm	KM 720/07	←			KM 720/15
↑		1,0 mm	KM 720/08	→			KM 720/16
↓		1,0 mm	KM 720/09	←			KM 720/17
							KM 720/18

AA
AB
AC
AD
AE
AF
AK
AL
AO
AP
AR
KA
KL
KM
KO
KU
KYE
X

KM



1/1

SCHUKNECHT
16,5 cm/6 1/2"

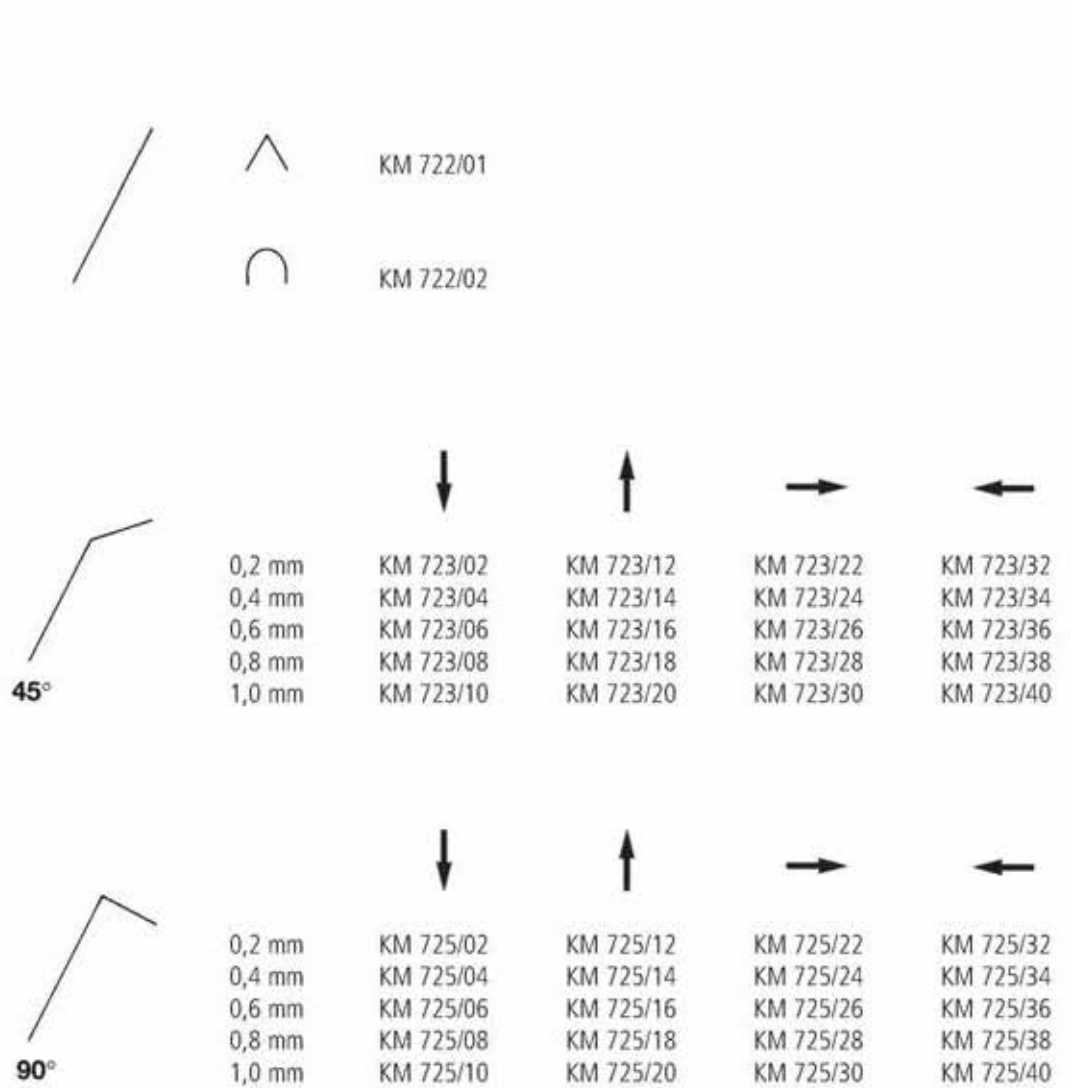

OHR OTOLGY OTOLOGIA OTOLOGIE OTOLOGIA

Küretten, Elevatorien, Raspatorien
 Curettes, Elevators, Raspatories
 Curetas, Elevadores, Legras
 Curettes, Elévateurs, Rugines
 Curette, Elevatori, Periostotomi

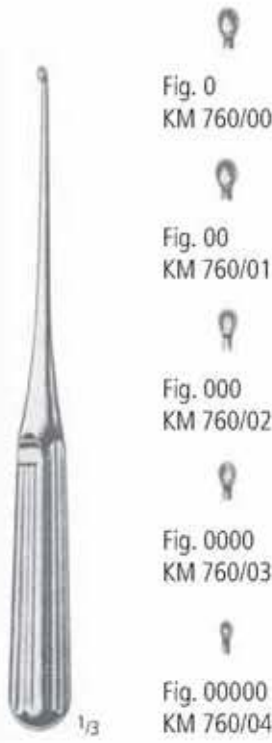

LEMPERT
 21,0 cm/8¹/₄"



WULLSTEIN
 16,0 cm/6¹/₄"



LEMPERT
 KM 764/03
 16,0 cm/6¹/₄"



SHAMBAUGH-DERLACKI
 KM 765/16
 16,5 cm/6¹/₂"



LEMPERT
 17,0 cm/6³/₄"



2 mm
 KM 766/02



3 mm
 KM 766/03



4 mm
 KM 766/04



5 mm
 KM 766/05

AA
 AB
 AC
 AD
 AE
 AF
 AK
 AL
 AO
 AP
 AR
 KA
 KL
 KM
 KO
 KU
 KYE
 X

Saugrohre
Suction Tubes
Tubos de aspiración
Canules d'aspiration
Cannule per aspirazione



HOUSE

0,9 + 0,7 mm	KM 830/09
1,2 + 0,9 mm	KM 830/12
1,5 + 1,2 mm	KM 830/15
1,8 + 1,8 mm	KM 830/18
2,5 + 2,0 mm	KM 830/25
3,0 + 2,0 mm	KM 830/30
4,5 + 2,0 mm	KM 830/45



BARON (SCHUKNECHT)

1,0 mm x 75 mm	KM 832/10
1,5 mm x 75 mm	KM 832/15
2,0 mm x 75 mm	KM 832/20



ZÖLLNER
KM 835/00



Ø 0,5 mm KM 835/05
Ø 0,7 mm KM 835/07



WULLSTEIN
KM 836/00



WULLSTEIN
KM 837/00



HOUSE

0,6 mm	KM 838/06
0,8 mm	KM 838/08
1,0 mm	KM 838/10
1,2 mm	KM 838/12
1,5 mm	KM 838/15
1,8 mm	KM 838/18
2,0 mm	KM 838/20
2,2 mm	KM 838/22
2,5 mm	KM 838/25
3,0 mm	KM 838/30



COTTLE
KM 850/24
19,0 cm/7 1/2"
240 g



HAJEK
KM 851/14
22,0 cm/8 3/4"
140 g



HARTMANN
14,0 cm/5 1/2"

- KM 858/00
- KM 858/01
- KM 858/02
- KM 858/03
- KM 858/04
- 1/1 KM 858/05

AA
AB
AC
AD
AE
AF
AK
AL
AO
AP
AR
KA
KL
KM
KO
KU
KYE
X

Stimmgabeln
Tuning forks
Diapasones
Diapasons
Diapason



HARTMANN



LUCAE



HARTMANN-FRENCH

c² 16
c² 32
c 64
c 128
c¹ 256
c² 512
c³ 1024
c⁴ 2048
c⁵ 4096

KM 862/00
KM 862/01
KM 862/02
KM 862/03
KM 862/04
KM 862/05

KM 863/00
KM 863/01
KM 863/02
KM 863/03
KM 863/04
KM 863/05

KM 864/00
KM 864/01
KM 864/02
KM 864/03
KM 864/04



KM 865/05 = KM 862/02
KM 862/03
KM 862/04
KM 864/03
KM 864/04

KM 865/06 = KM 862/02
KM 862/03
KM 862/04
KM 862/05
KM 864/03
KM 864/04

KM 865/08 = KM 862/02
KM 862/03
KM 862/04
KM 862/05
KM 864/01
KM 864/02
KM 864/03
KM 864/04

Stimmgabeln
Tuning Forks
Diapasones
Diapasons
Diapason

ALU

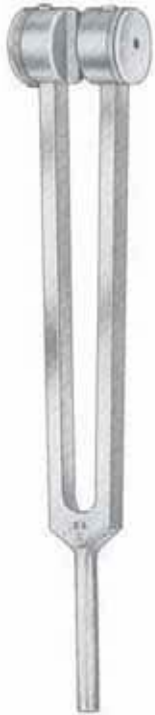

C 64

KM 866/01



C 128

KM 866/02



C 256

KM 866/03

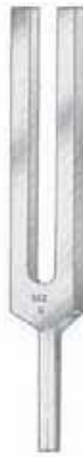

C 512

KM 866/04



C 1024

KM 866/05



C 2048

KM 866/06



C 4096

KM 866/07



KM 867/05 = KM 866/02
KM 866/03
KM 866/04
KM 866/05
KM 866/06

AA
AB
AC
AD
AE
AF
AK
AL
AO
AP
AR
KA
KL
KM
KO
KU
KYE
X

Luftdusche, Pulverbläser
Air Bag, Powder Blower
Insufladores, Pulverizadores
Insufflateurs
Insuffiatori



KM 890/01



Ø 15 mm = KM 890/15
Ø 17 mm = KM 890/17
Ø 22 mm = KM 890/22



KM 890/30

POLITZER

- KM 890/00 =** KM 890/01
KM 890/15
KM 890/17
KM 890/22
KM 890/30



KM 892/01

KM 892/02
30 ccm

KABIERSKE

- KM 892/00 =** KM 892/01
KM 892/02
KM 892/08
KM 892/11
KM 892/13



8,0 cm/3" KM 892/08



11,0 cm/4 1/3" KM 892/11



13,0 cm/5" KM 892/13

OHR OTOLGY OTOLOGIA OTOLOGIE OTOLOGIA

Ohrspritzen
 Ear Syringes
 Jeringas auriculares
 Seringues auriculaires
 Siringhe per orecchio



KM 898/01



KM 898/02



KM 898/03



50 ml KM 898/05
 75 ml KM 898/08
 100 ml KM 898/10
 komplett
 complete
 completo
 complet
 completo

AA
 AB
 AC
 AD
 AE
 AF
 AK
 AL
 AO
 AP
 AR
 KA
 KL
 KM
 KO
 KU
 KYE
 X

HNO
ENT
ORL

KO

nopa[®] instruments

Rhinologie
Rhinology
Rinologia
Rhinologie
Rinologia

Seite 329-374
Page 329-374
Página 329-374
Page 329-374
Pagina 329-374



NASE RHINOLOGY RINOLOGIA RHINOLOGIE RINOLOGIA

Nasenspekula
Nasal Specula
Especulos nasales
Spéculums nasaux
Specoli nasali



HARTMANN-HALLE
15,0 cm/6"

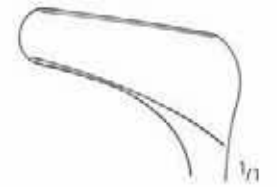

KO 050/01



KO 050/02



KO 050/03



HARTMANN
15,0 cm/6"

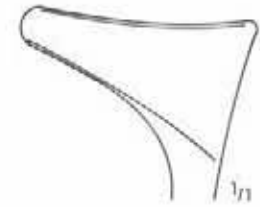

KO 052/01

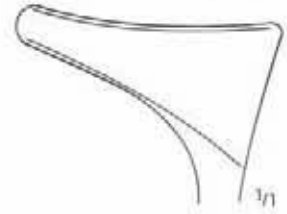

KO 052/02

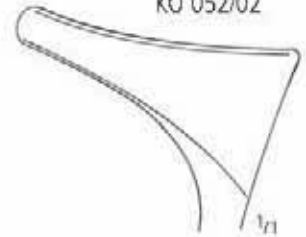

KO 052/03



TIECK-HALLE
13,5 cm/5 1/4"



KO 060/01



KO 060/02



BECKMANN
KO 063/13
13,0 cm/5"



BECKMANN
15,0 cm/6"



KO 065/01



KO 065/02

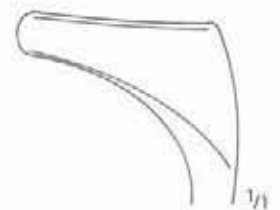

KO 065/03

AA
AB
AC
AD
AE
AF
AK
AL
AO
AP
AR
KA
KL
KM
KO
KU
KYE
X

KO NASE RHINOLOGY RINOLOGIA RHINOLOGIE RINOLOGIA

Nasenspekula
Nasal Specula
Espéculos nasales
Spéculums nasaux
Specoli nasali



KILLIAN
13,0 cm/5"

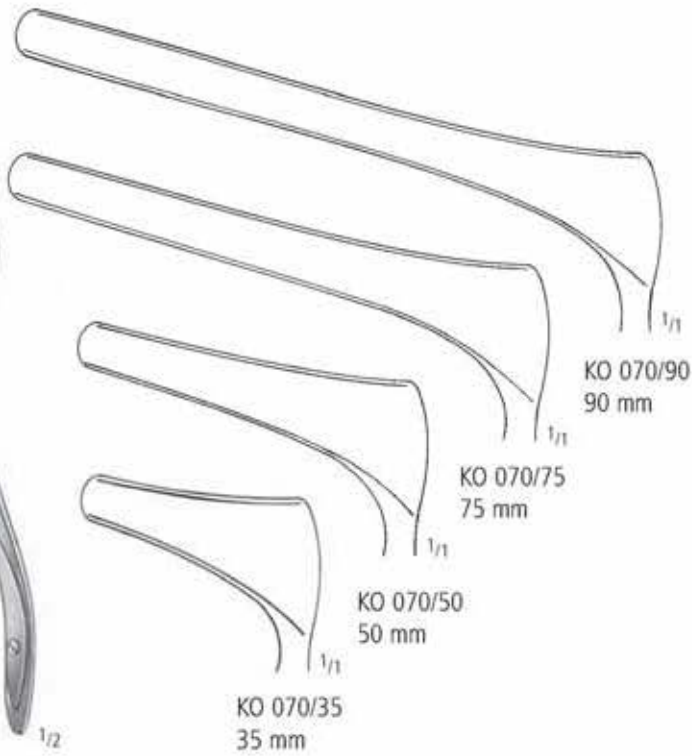

MOD. WIEN
14,5 cm/5³/₄"

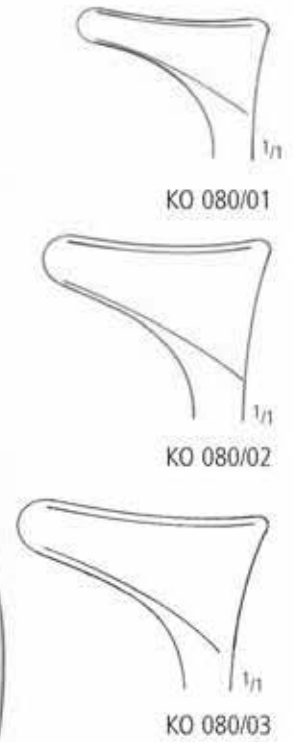

COTTLE
KO 090/01-04
15,0 cm/6"

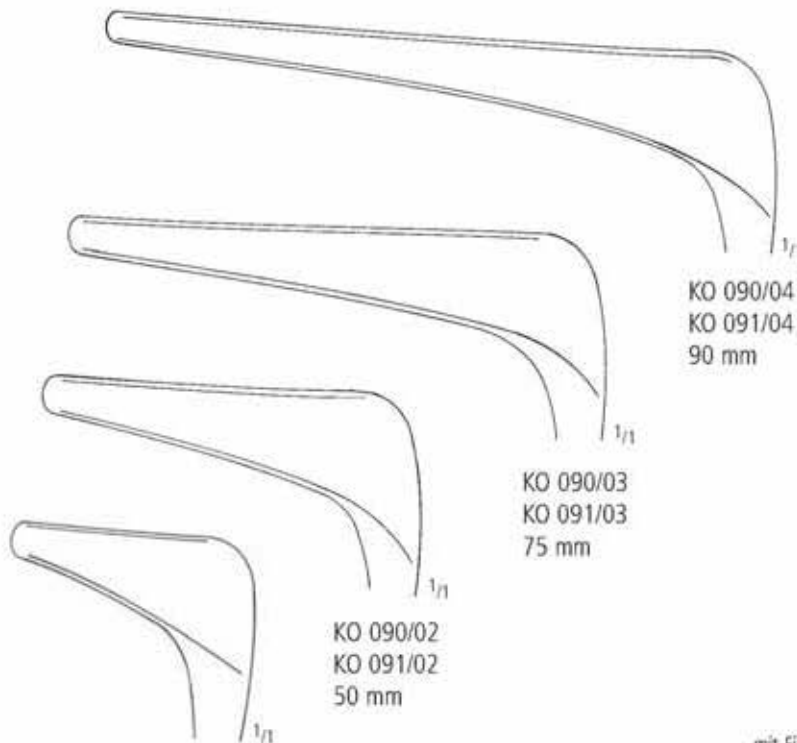

mit Fixierschraube
with fixing screw
con tornillo de fijación
avec vis de fixation
con vite fissaggio

COTTLE
KO 091/01-04
15,0 cm/6"

Nasenspekula
Nasal Specula
Espéculos nasales
Spéculum nasaux
Specoli nasali



**THUDICHUM
(GOLDSMITH)**
6,5 cm/2 1/2"



KO 094/01



KO 094/02



KO 094/03



**VOLTOLINI
(DUPLAY)**



KO 095/01



KO 095/02



KO 095/03

Alle Nasenspekula sind auch in schwarz verchromter Ausführung lieferbar.
Für die Bestellung fügen Sie bitte den Buchstaben B zur normalen Katalognummer hinzu.
Zum Beispiel: KO 090/01 B.

All nasal specula are also available in black finish. For ordering kindly add the letter B to the regular catalogue number. For example: KO 090/01 B.

Todos los espéculos nasales también están disponibles en acabado negro. Al ordenar, por favor añada la letra B a nuestro número de catálogo normal. Por ejemplo: KO 090/01 B.

Tous les spéculum nasaux sont également disponibles en finition noire. Pour commander indiquer la lettre B après la référence normale du catalogue. Par exemple: KO 090/01 B.

Tutti gli specoli nasali sono anche disponibili con finitura nera. Per gli ordinativi di acquisto, aggiungere la lettera B al numero di catalogo normale. Per esempio: KO 090/01 B.

AA
AB
AC
AD
AE
AF
AK
AL
AO
AP
AR
KA
KL
KM
KO
KU
KYE
X

Polypenschnürer
 Nasal Snares
 Polipótomos
 Serre-noeuds pour polypes
 Serranodí per polipi



KRAUSE
 KO 100/00
 26,0 cm/10¹/₂"



KRAUSE-VOSS
 KO 102/00
 26,0 cm/10¹/₂"



LANGE-WILDE
 KO 104/00
 24,0 cm/9¹/₂"



KO 120/12

Bündel mit 12 Stück
 bundles of 1 dozen each
 en atados de 12 piezas
 en paquets de 12 pièces
 in fascetti di 12 pezzi



10,0 m/33 ft.

0,3 mm KO 121/03
 0,4 mm KO 121/04

NASE RHINOLOGY RINOLOGIA RHINOLOGIE RINOLOGIA

Polypenzangen
 Nasal Polypus Forceps
 Pinzas para pólipos
 Pincès à polypes nasaux
 Pinze per polipi nasali



HARTMANN
 KO 150/16 16,0 cm/6¹/₄"
 KO 150/20 20,0 cm/8"

HEYMANN-KNIGHT
 KO 151/18
 18,0 cm/7"

LUBET-BARBON
 KO 152/20
 20,0 cm/8"

KILLIAN
 KO 153/17
 17,0 cm/6³/₄"

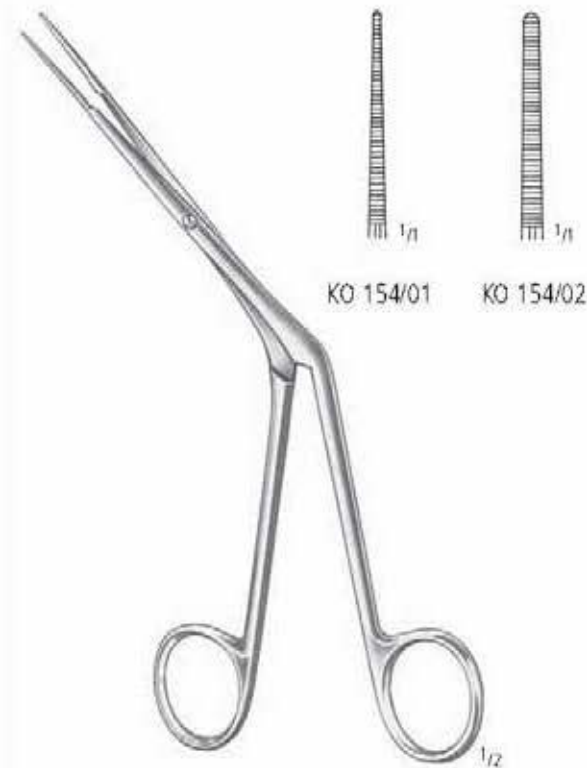

KO 154/01 KO 154/02

WESTMACOTT
 20,0 cm/8"



HARTMANN
 KO 155/19
 19,0 cm/7¹/₂"

AA
 AB
 AC
 AD
 AE
 AF
 AK
 AL
 AO
 AP
 AR
 KA
 KL
 KM
 KO
 KU
 KYE
 X

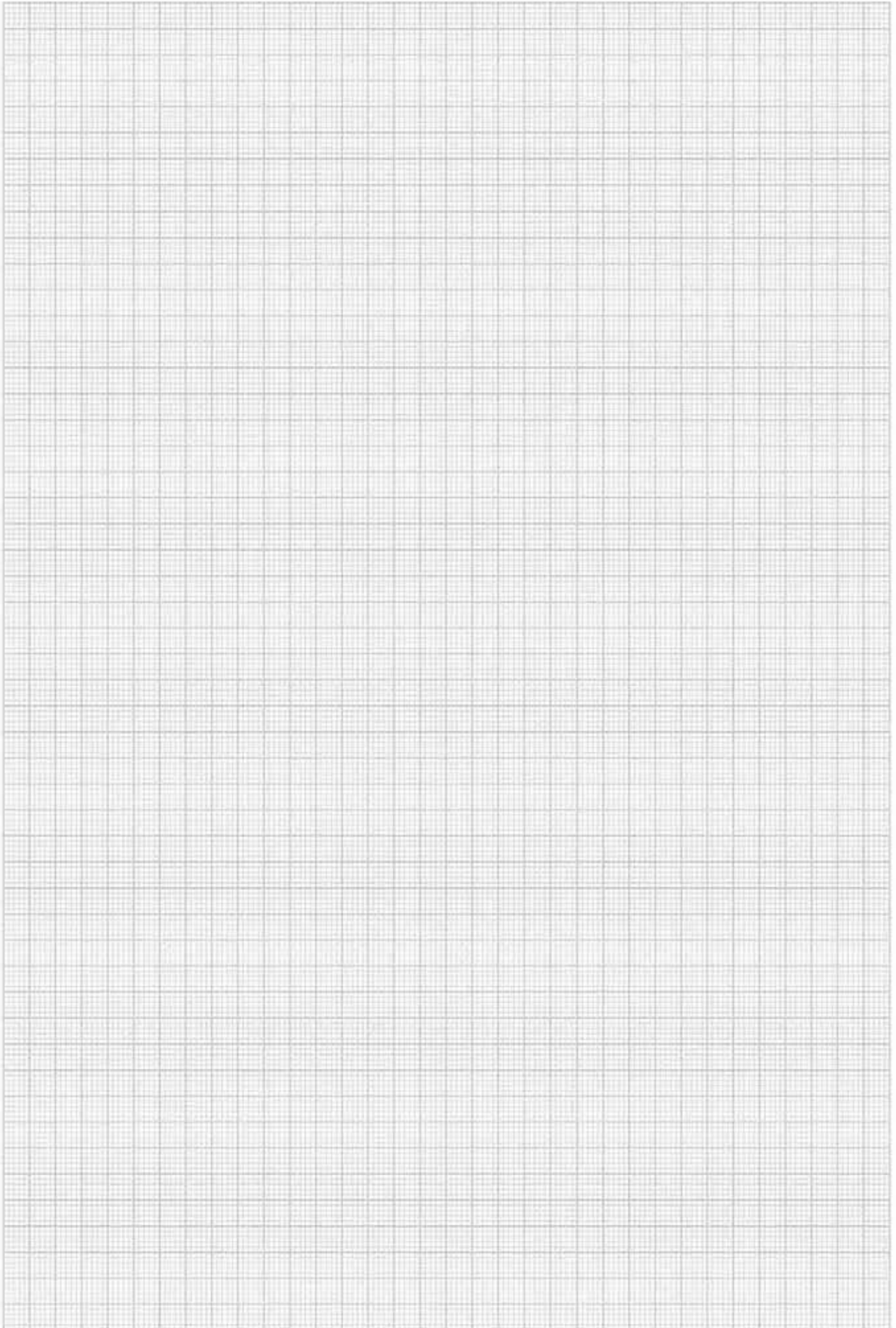

Stirnhöhlenstanze
 Frontal sinus punch forceps
 Pinzas para seno frontal
 Pincès pour sinus frontal
 Pinze per seno frontale

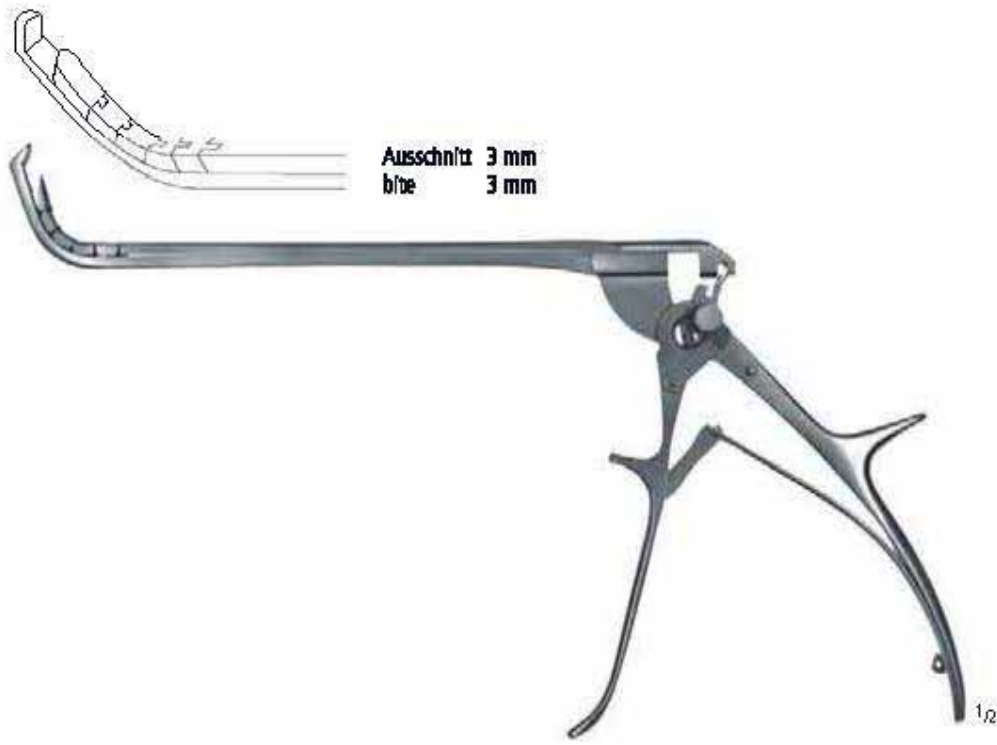

KD 165/03

- AA
- AB
- AC
- AD
- AE
- AF
- AK
- AL
- AD
- AP
- AR
- KA
- KL
- KM
- KO**
- KU
- KYE
- X

Sinuskopie-Zangen
 Sinuscopy Forceps
 Pinzas para senoscopia
 Pince à sinus
 Pinze per sinuscopia

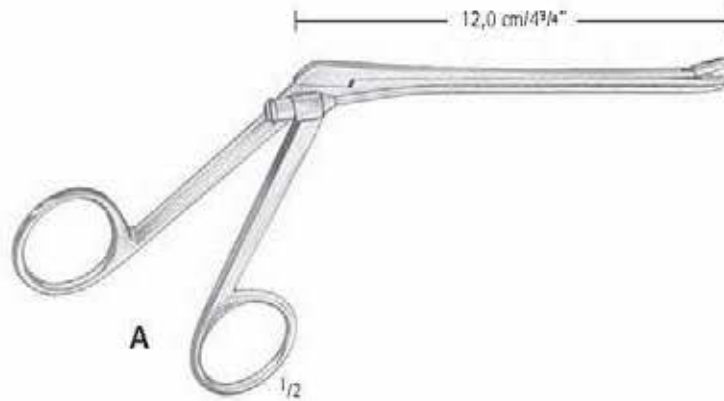

WEIL-BLAKESLEY

		2,5 mm	3,0 mm	3,5 mm
	0°	A KO 170/01	KO 170/02	KO 170/03
		B KO 170/11	KO 170/12	KO 170/13
	45°	A KO 170/06	KO 170/07	KO 170/08
		B KO 170/16	KO 170/17	KO 170/18
	90°	A KO 170/21	KO 170/22	KO 170/23
		B KO 170/31	KO 170/32	KO 170/33

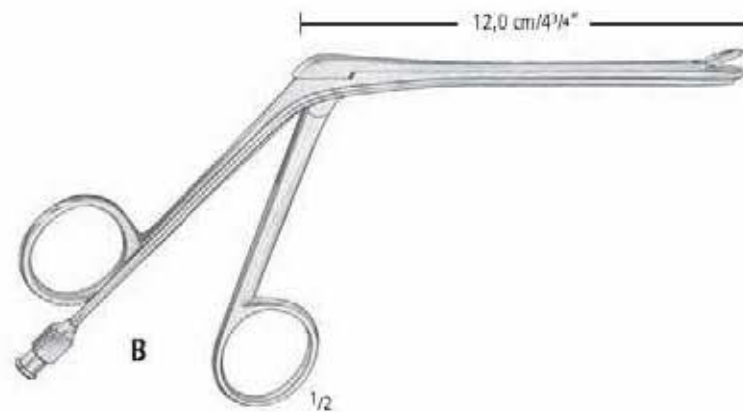



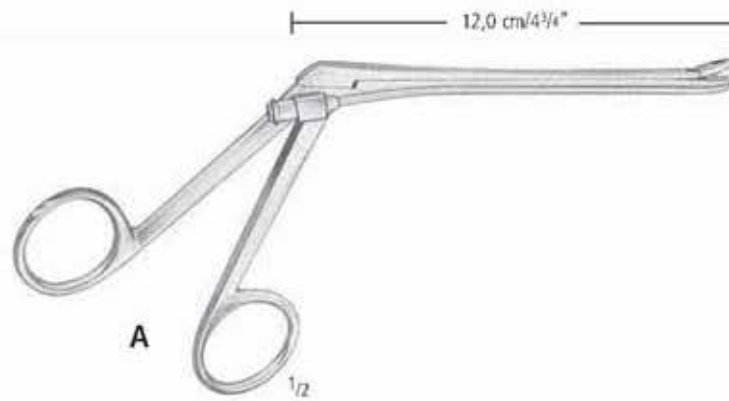

WEIL-BLAKESLEY

Sinuskopie-Zangen
 Sinuscopy Forceps
 Pinzas para senoscopia
 Pince à sinus
 Pinze per sinuscopia



WEIL-BLAKESLEY

					
			2,5 mm	3,0 mm	3,5 mm
	rechts right	A B	KO 170/40 KO 170/50	KO 170/41 KO 170/51	KO 170/42 KO 170/52
	links left	A B	KO 170/45 KO 170/55	KO 170/46 KO 170/56	KO 170/47 KO 170/57

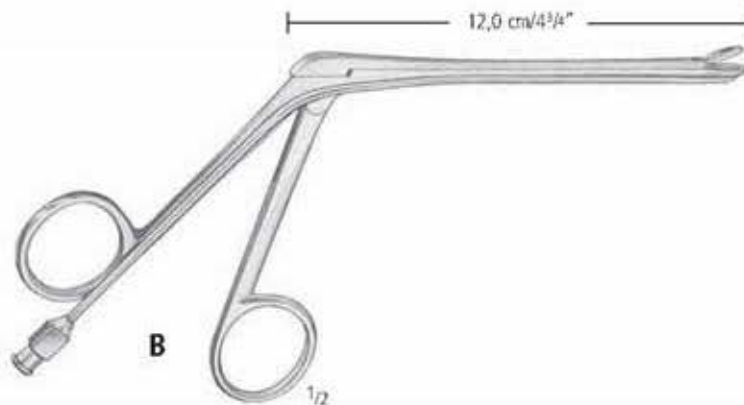

WEIL-BLAKESLEY

AA
AB
AC
AD
AE
AF
AK
AL
AO
AP
AR
KA
KL
KM
KO
KU
KYE
X

KO NASE RHINOLOGY RINOLOGIA RHINOLOGIE RINOLOGIA

Sinuskopie-Zangen
 Sinuscopy Forceps
 Pinzas para senoscopia
 Pince à sinus
 Pinze per sinusopia

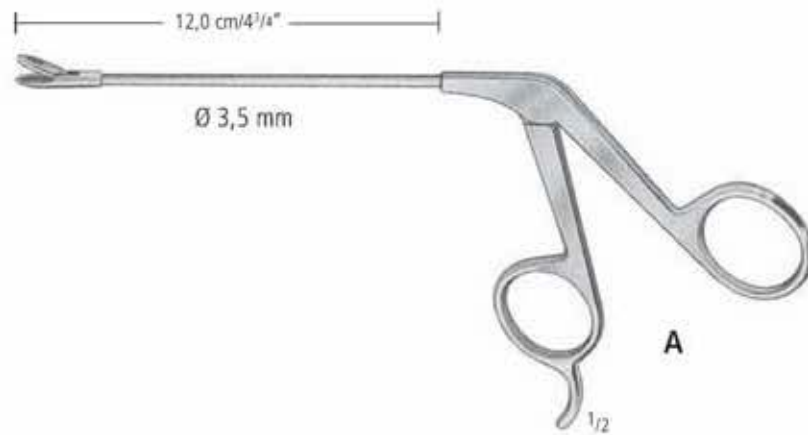

		2,5 mm	3,0 mm	3,5 mm	4,0 mm
WEIL-BLAKESLEY 0°	A	KO 171/01	KO 171/02	KO 171/03	KO 171/04
	B	KO 171/11	KO 171/12	KO 171/13	KO 171/14
		2,5 mm	3,0 mm	3,5 mm	4,0 mm
WEIL-BLAKESLEY 45°	A	KO 171/06	KO 171/07	KO 171/08	KO 171/09
	B	KO 171/16	KO 171/17	KO 171/18	KO 171/19
		4,0 x 10,0 mm			
TAKAHASHI	A	KO 171/27			
	B	KO 171/37			
		1,0 x 10,0 mm			
STRUYCKEN	A	KO 171/28			
	B	KO 171/38			

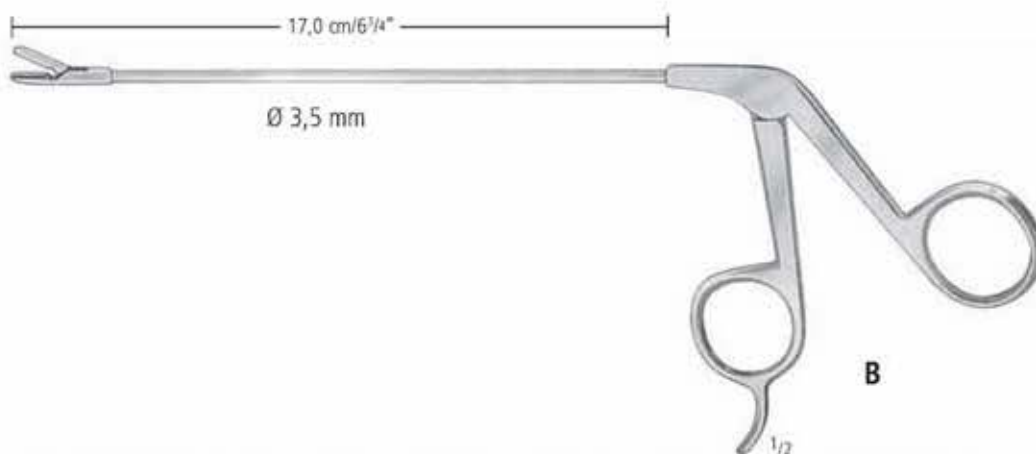

NASE RHINOLOGY RINOLOGIA RHINOLOGIE RINOLOGIA

Sinuskopie-Zangen
 Sinuscopy Forceps
 Pinzas para senoscopia
 Pince à sinus
 Pinze per sinuscopia

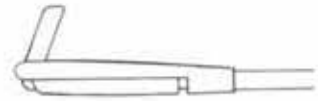
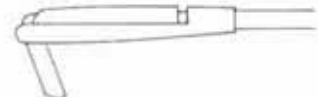

	1,5 x 6,0 mm	2,0 x 6,0 mm	2,5 x 8,0 mm
 1/1	KO 175/01	KO 175/02	KO 175/03
 1/1	KO 175/11	KO 175/12	KO 175/13
 1/1	KO 175/21	KO 175/22	KO 175/23

STANZEN
 PUNCHES

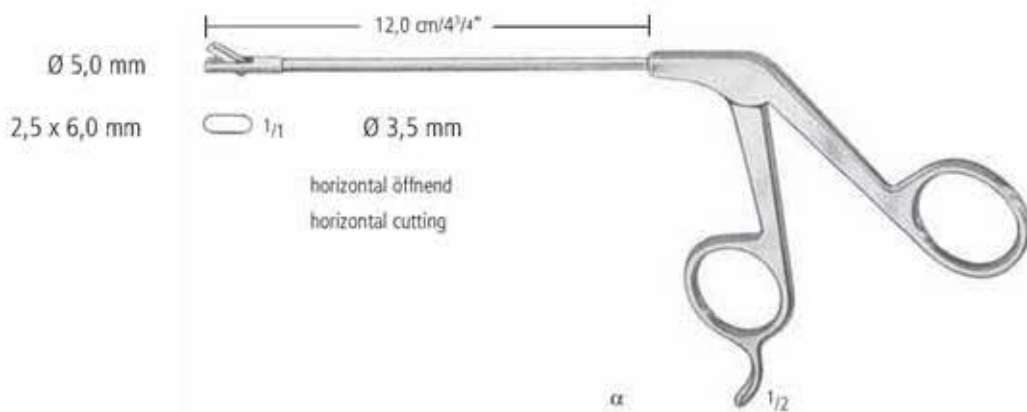

- α
- 0° KO 176/01
 - 30° KO 176/02
 - 45° KO 176/03
 - 60° KO 176/04
 - 70° KO 176/05

AA
 AB
 AC
 AD
 AE
 AF
 AK
 AL
 AO
 AP
 AR
 KA
 KL
 KM
 KO
 KU
 KYE
 X

Sinuskopie-Zangen
 Sinuscopy Forceps
 Pinzas para senoscopia
 Pince à sinus
 Pinze per sinuscopia

glatt
smooth



KO 180/01



KO 180/02



KO 180/03

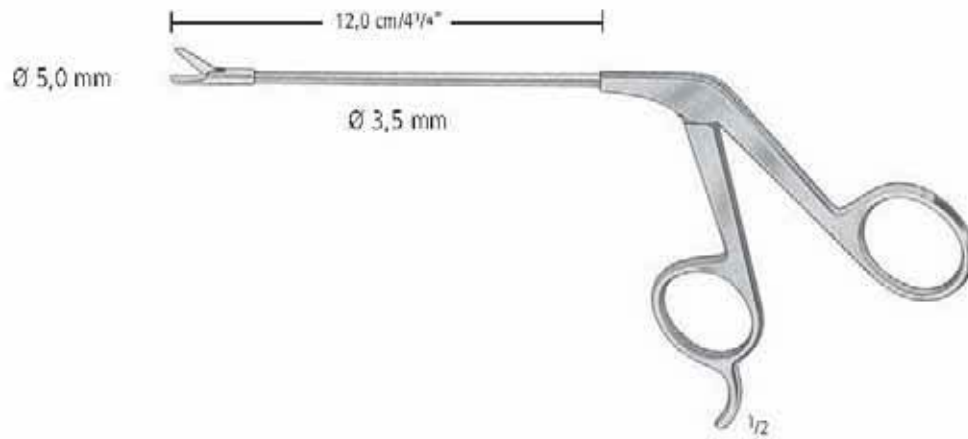

gezahnt
serrated



KO 180/11



KO 180/12



KO 180/13

Sinuskopie-Zangen
 Sinuscopy forceps
 Pinzas para senoscopia
 Pince à sinus
 Pinze per sinuscopia

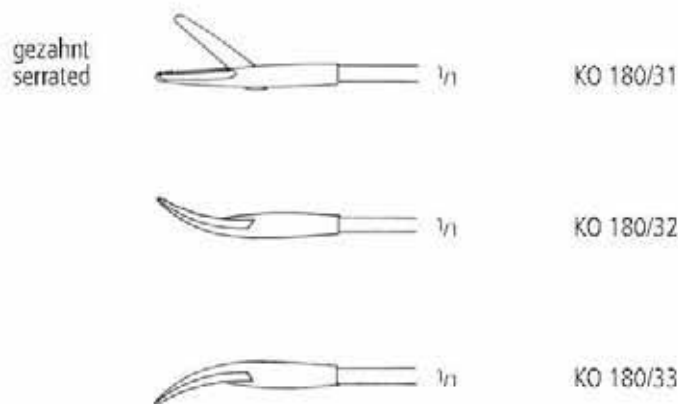
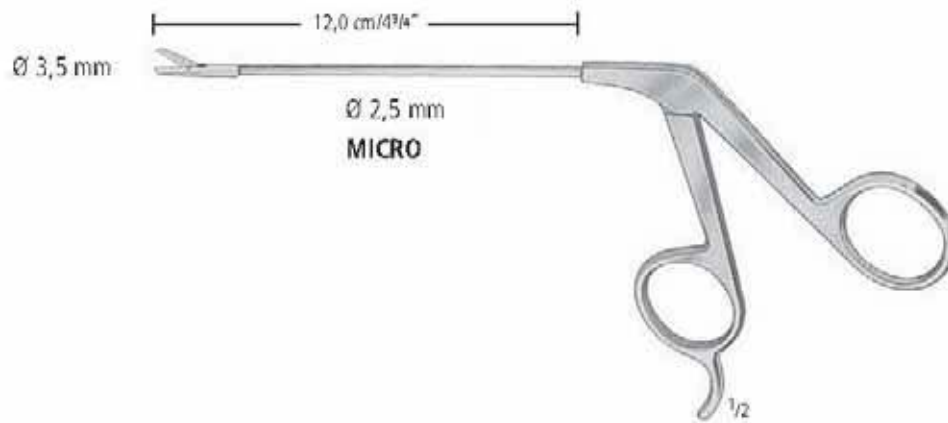
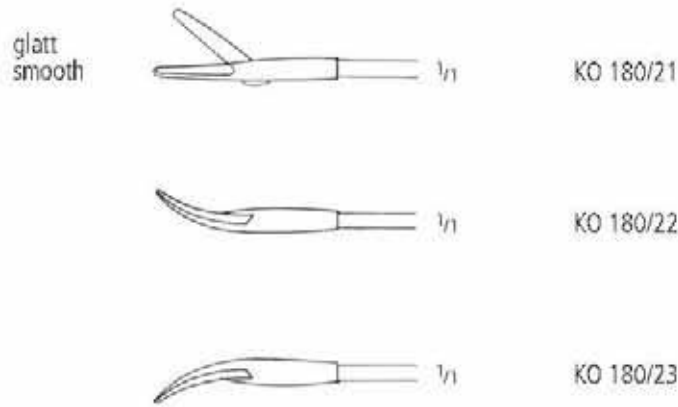

AA
AB
AC
AD
AE
AF
AK
AL
AO
AP
AR
KA
KL
KM
KO
KU
KYE
X

KO NASE RHINOLOGY RINOLOGIA RHINOLOGIE RINOLOGIA

Sinuskopie-Zangen
 Sinuscopy Forceps
 Pinzas para senoscopia
 Pinze à sinus
 Pinze per sinuscopia

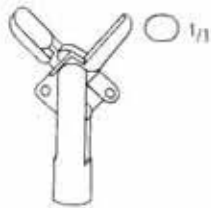

3,5 mm x 4,0 mm

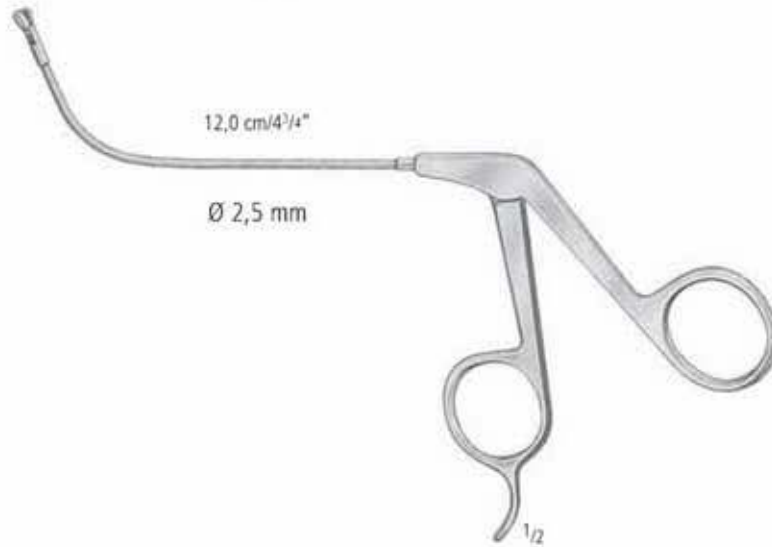

70°
 90°
 110°

horizontal öffnend
 horizontal cutting

vertikal öffnend
 vertical cutting

KO 185/01
 KO 185/02
 KO 185/03

KO 185/11
 KO 185/12
 KO 185/13



Ø 3,0 mm

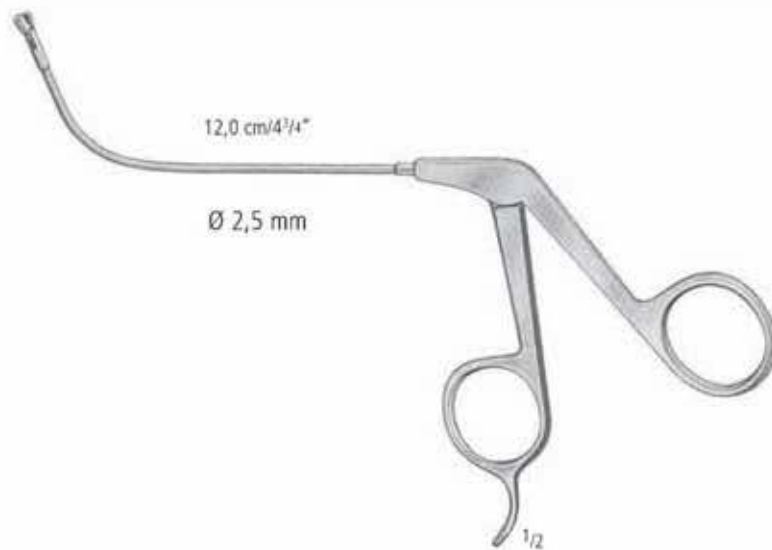

STAMMBERGER



65°

horizontal öffnend
 horizontal cutting

vertikal öffnend
 vertical cutting

KO 186/01

KO 186/02

NASE RHINOLOGY RINOLOGIA RHINOLOGIE RINOLOGIA

Scharfe Nasenzangen
 Nasal Cutting Forceps
 Pinzas cortantes para nariz
 Pincas coupantes pour le nez
 Pinze taglianti per il naso



1/1

KO 200/01



1/1

KO 200/02



1/1

KO 200/03



1/1

KO 200/04



1/1

KO 200/05



WEIL-BLAKESLEY



1/1

KO 201/01



1/1

KO 201/02



1/1

KO 201/03



WEIL-BLAKESLEY

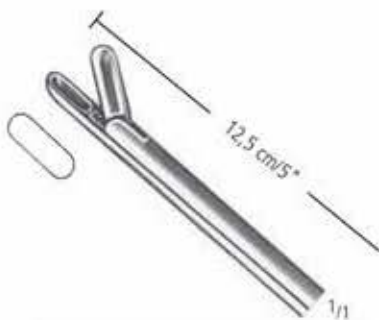

WATSON-WILLIAMS
 KO 203/12

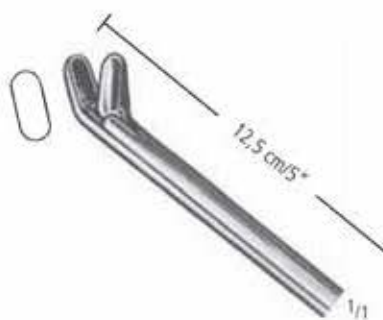



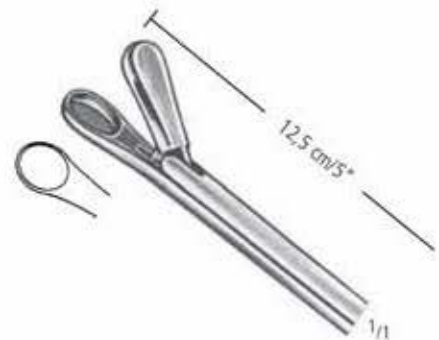

WATSON-WILLIAMS
 KO 204/12



WATSON-WILLIAMS
 KO 205/12

AA
 AB
 AC
 AD
 AE
 AF
 AK
 AL
 AO
 AP
 AR
 KA
 KL
 KM
 KO
 KU
 KYE
 X

Scharfe Nasenzangen
 Nasal Cutting Forceps
 Pinzas cortantes para nariz
 Pincas coupantes pour le nez
 Pinze taglianti per il naso

-  $\frac{1}{n}$ 5 mm
KO 210/05
-  $\frac{1}{n}$ 7 mm
KO 210/07
-  $\frac{1}{n}$ 9 mm
KO 210/09
-  $\frac{1}{n}$ 11 mm
KO 210/11



HARTMANN

 $\frac{1}{n}$
KO 212/01

 $\frac{1}{n}$
KO 212/02

 $\frac{1}{n}$
KO 212/03

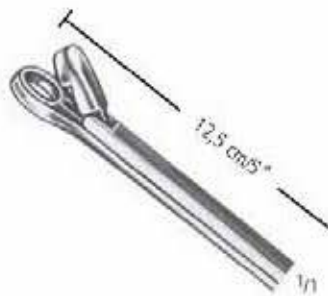

GRUENWALD

 $\frac{1}{n}$
KO 214/01

 $\frac{1}{n}$
KO 214/02

 $\frac{1}{n}$
KO 214/03



SCHMEDEN

 $\frac{1}{n}$
KO 215/01

 $\frac{1}{n}$
KO 215/02



STRUYCKEN

 $\frac{1}{n}$
KO 216/01

 $\frac{1}{n}$
KO 216/03

 $\frac{1}{n}$
KO 216/02

 $\frac{1}{n}$
KO 216/04



MYLES

NASE RHINOLOGY RINOLOGIA RHINOLOGIE RINOLOGIA

Scharfe Nasenzangen
 Nasal Cutting Forceps
 Pinzas cortantes para nariz
 Pincas coupantes pour le nez
 Pinze taglianti per il naso



TAKAHASHI

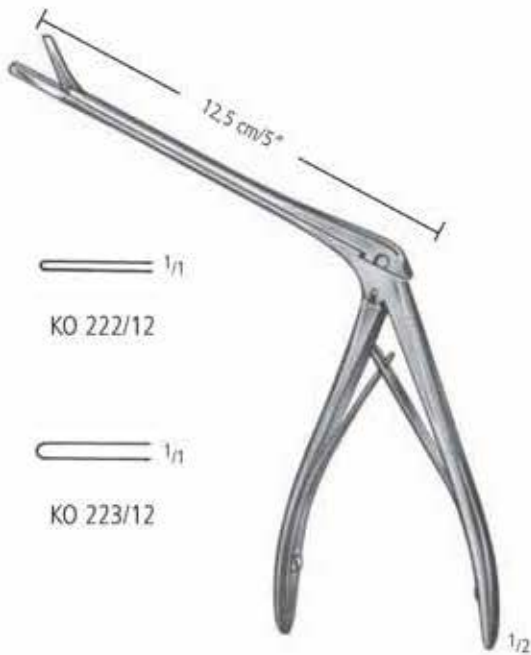

STRUYCKEN



JANSEN-MIDDLETON

KO 225/19
 19,0 cm/7 1/2"



JANSEN-MIDDLETON

KO 226/19
 19,0 cm/7 1/2"

AA
 AB
 AC
 AD
 AE
 AF
 AK
 AL
 AO
 AP
 AR
 KA
 KL
 KM
KO
 KU
 KYE
 X

KO NASE RHINOLOGY RINOLOGIA RHINOLOGIE RINOLOGIA

Siebbein- und Septumzangen
 Ethmoid and Septum Forceps
 Pinzas para etmoides y para el tabique nasal
 Pince ethmoïdales et pour la cloison nasale
 Pinze etmoidali e per il setto nasale

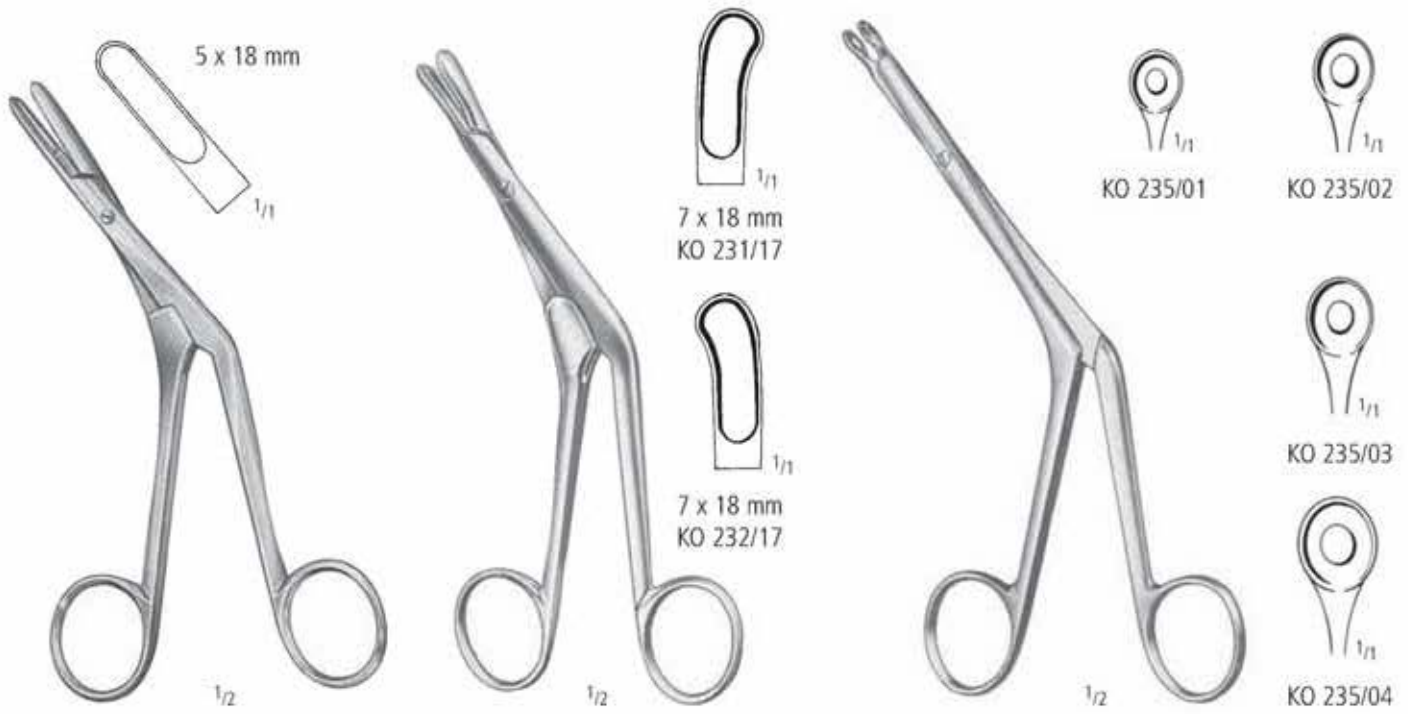

CRAIG
 KO 230/17
 17,0 cm/6³/₄"

CRAIG-DOMNICK
 17,0 cm/6³/₄"

BRUENINGS
 19,0 cm/7¹/₂"

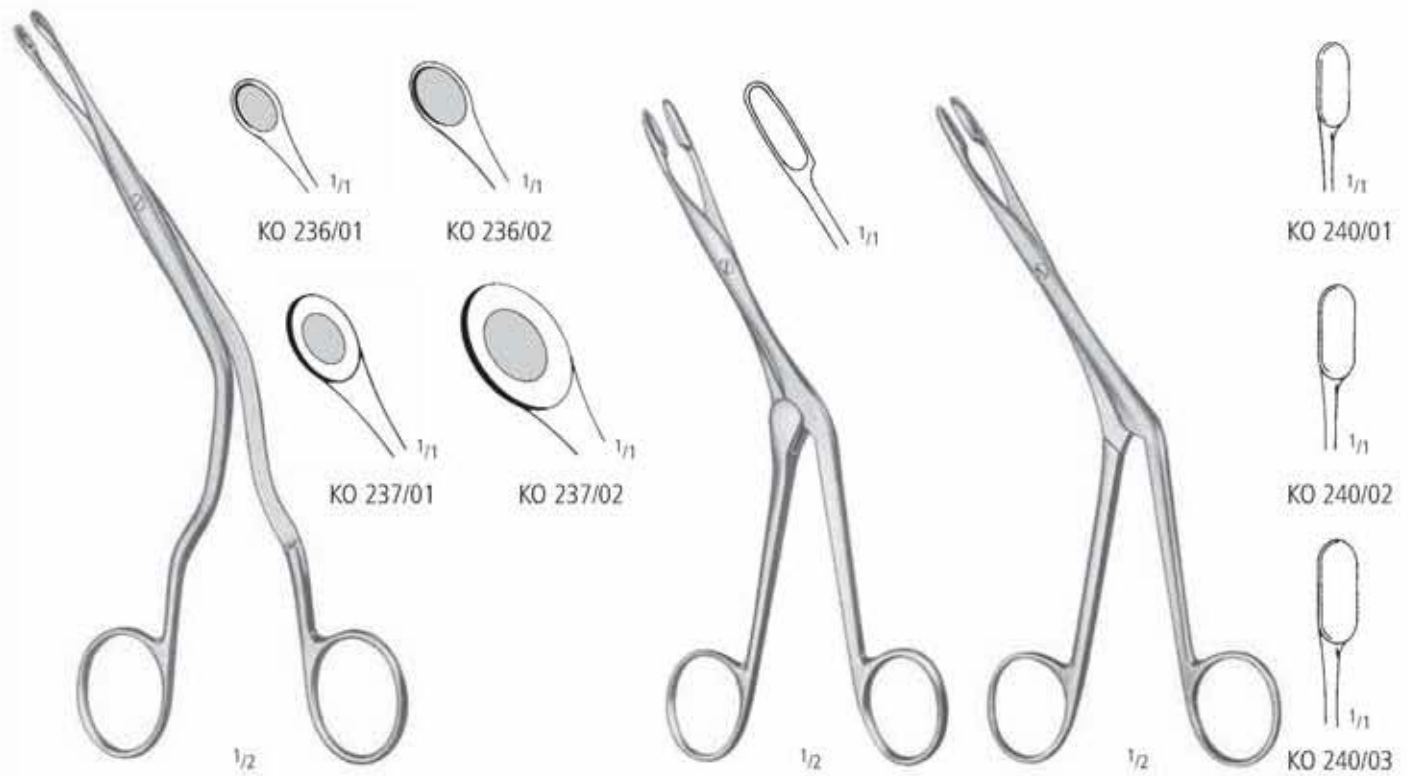

LUC
 20,0 cm/8"

KNIGHT
 KO 238/18
 18,0 cm/7"

HEYMANN
 18,0 cm/7"

NASE RHINOLOGY RINOLOGIA RHINOLOGIE RINOLOGIA

Keilbeinstanzen
Sphenoid Punches
Pinzas para seno esfenoidal
Pinces pour sinus sphénoïdal
Pinze per seno sfenoidale

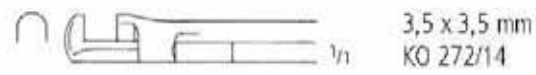
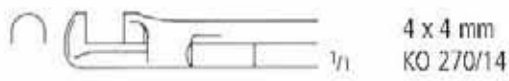

HAJEK-KOFFLER

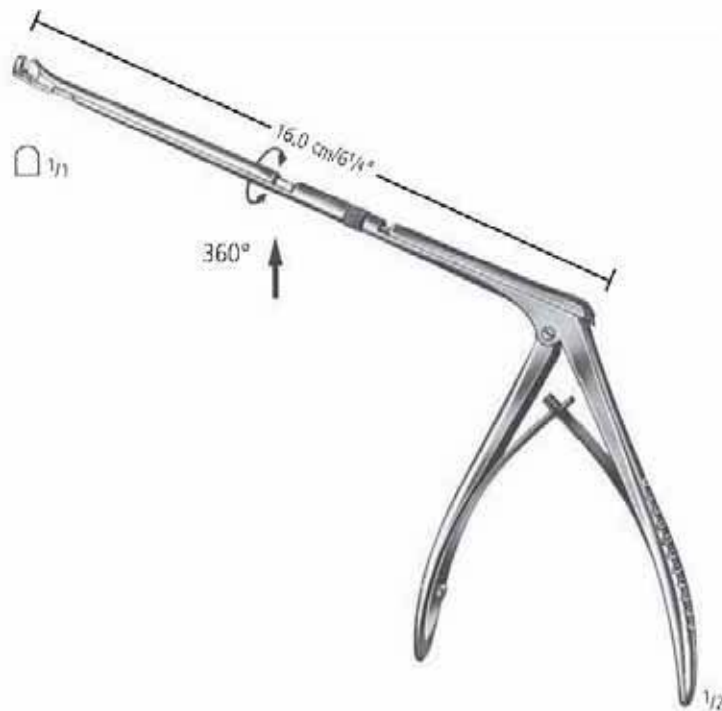

HAJEK-KOFFLER
KO 274/16



KERRISON

AA
AB
AC
AD
AE
AF
AK
AL
AO
AP
AR
KA
KL
KM
KO
KU
KYE
X

Keilbeinstanzen
 Sphenoid Punches
 Pinzas para seno esfenoidal
 Pincès pour sinus sphénoïdal
 Pinze per seno sfenoidale

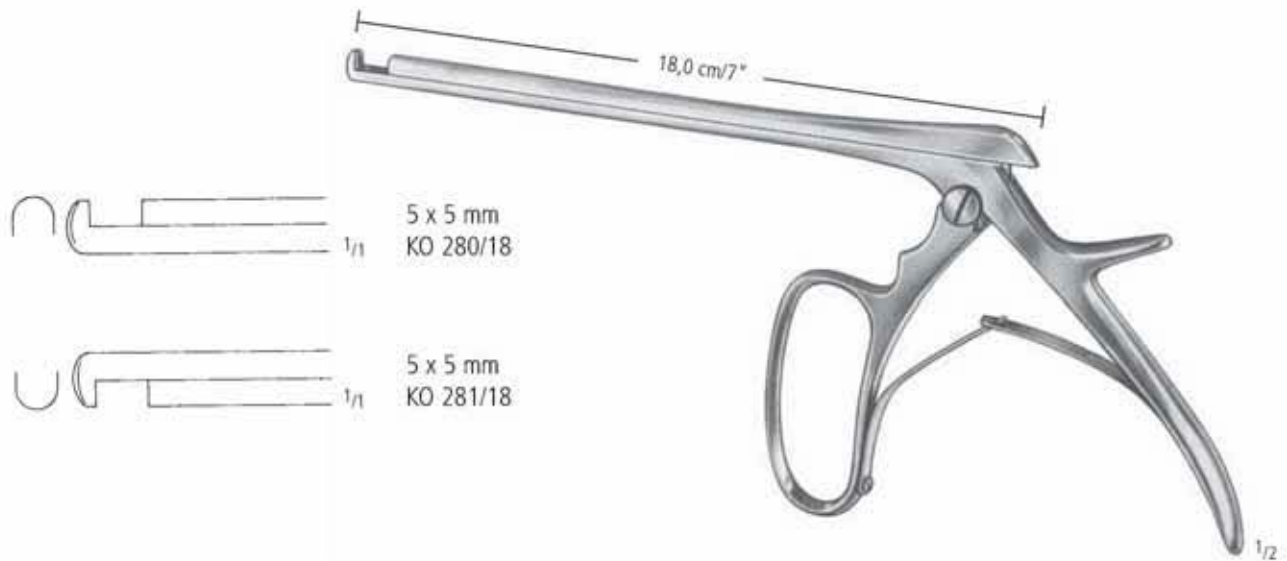

FERRIS-SMITH



HAJEK-CLAUS
 KO 285/20
 20,0 cm/8"

Weitere Stanzen in Gruppe KS.
 For further punches see section KS.
 Para otras pinzas cortantes ver seccion KS.
 D'autres pincès coupantes voir groupe KS.
 Altre pinze taglienti vedi gruppo KS.

NASE RHINOLOGY RINOLOGIA RHINOLOGIE RINOLOGIA

Nasenplastik- und Operationsmesser
 Rhinoplastic and Nasal Knives
 Bisturios para operaciones de la nariz
 Bistouris pour opérations du nez
 Bisturi per operazioni nasali

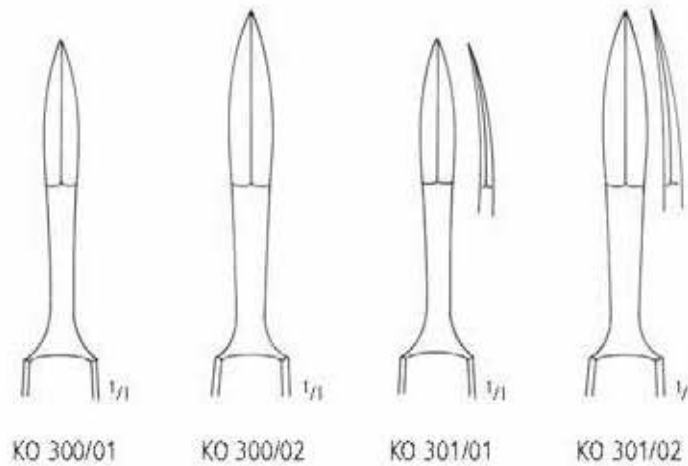

JOSEPH
 KO 300/01-KO 301/02
 14,5 cm/5³/₄"

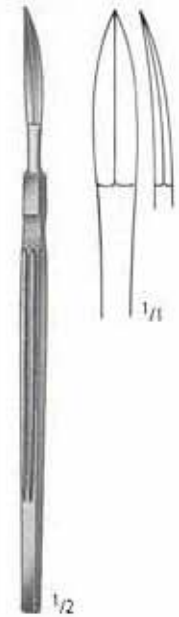

FOMON
 KO 304/16
 16,0 cm/6¹/₄"

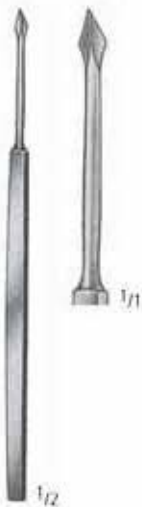

MASING
 KO 305/13
 13,0 cm/5"



COTTLE
 KO 306/15
 15,0 cm/6"

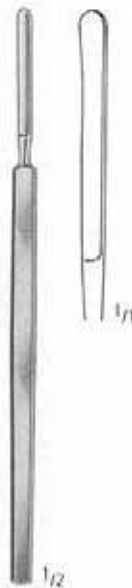

COTTLE
 KO 307/15
 15,0 cm/6"



CONVERSE
 KO 308/16
 16,0 cm/6¹/₄"

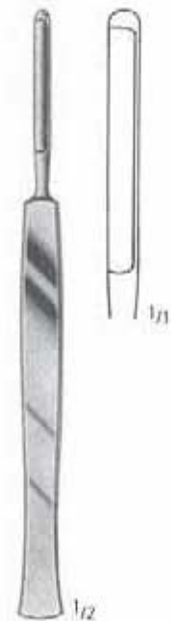

JOSEPH
 KO 309/15
 15,0 cm/6"

AA
 AB
 AC
 AD
 AE
 AF
 AK
 AL
 AO
 AP
 AR
 KA
 KL
 KM
KO
 KU
 KYE
 X

Nasenplastik- und Operationsmesser
 Rhinoplastic and Nasal Knives
 Bisturios para operaciones de la nariz
 Bistouris pour opérations du nez
 Bisturi per operazioni nasali



FREER "D"
 KO 310/01
 15,0 cm/6"



FREER "E"
 KO 310/02
 15,0 cm/6"



FREER
 KO 310/03
 15,0 cm/6"



KO 315/16
 Ersatzklinge
 Spare Blade
 Hoja de repuesto
 Lame de rechange
 Lama di ricambio

BRUENINGS
 KO 315/00
 16,0 cm/6 1/4"



JOSEPH
 KO 316/16
 16,5 cm/6 1/2"



MALTZ
 KO 317/16
 16,5 cm/6 1/2"

NASE RHINOLOGY RINOLOGIA RHINOLOGIE RINOLOGIA

Septummesser, Septum- und Periost-Elevatoren
 Septum Knives, Septum and Periosteal Elevators
 Bisturios para el tabique nasal y para el periostio, elevadores
 Bistouris pour la cloison et le périoste, éleveurs
 Bisturi per il setto ed il periostio, elevatori



BALLENGER
 KO 330/03-05
 20,0 cm/8"



3,0 mm
 KO 330/03
 KO 331/03



4,0 mm
 KO 330/04
 KO 331/04



5,0 mm
 KO 330/05
 KO 331/05



BALLENGER
 KO 331/03-05
 20,0 cm/8"



McKENTY



4,0 mm
 KO 340/04

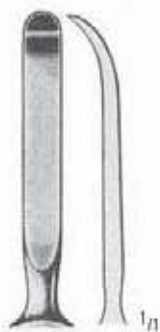

5,0 mm
 KO 340/05



JOSEPH-MASING
 KO 341/22
 22,0 cm/8³/₄"



HALLE
 KO 342/16
 16,5 cm/6¹/₂"



JOSEPH
 KO 343/16
 16,0 cm/6¹/₄"

AA
 AB
 AC
 AD
 AE
 AF
 AK
 AL
 AO
 AP
 AR
 KA
 KL
 KM
KO
 KU
 KYE
 X

Septum- und Periost-Elevatoren
 Septum and Periosteal Elevators
 Elevadores para el tabique nasal y para el periostio
 Élévateurs pour la cloison et le périoste
 Elevatori per il setto ed il periostio

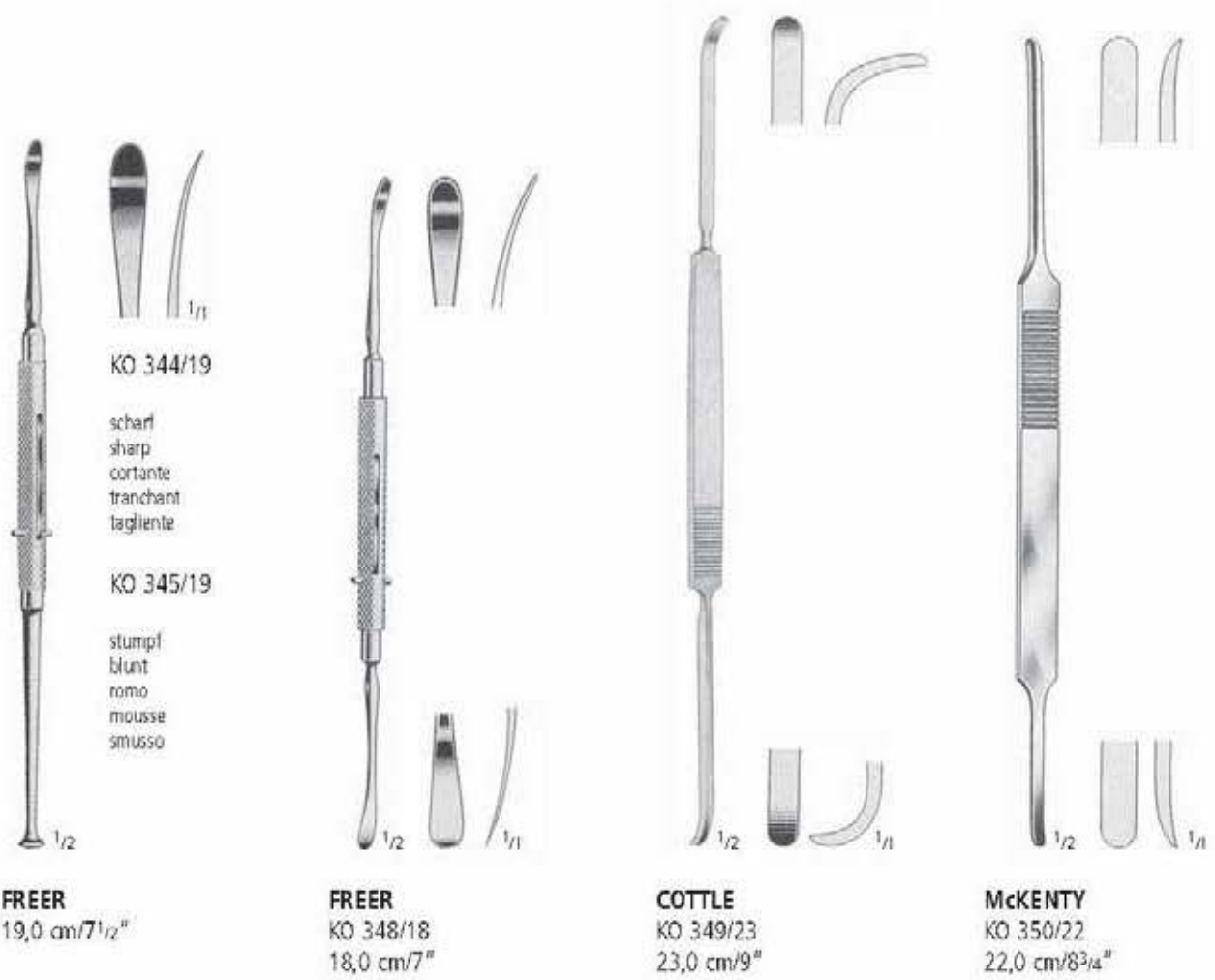

NASE RHINOLOGY RINOLOGIA RHINOLOGIE RINOLOGIA

Septum- und Periost-Elevatoren
 Septum and Periosteal Elevators
 Elevadores para el tabique nasal y para el periostio
 Élévateurs pour la cloison et le périoste
 Elevatori per il setto ed il periostio

AA
AB
AC
AD
AE
AF
AK
AL
AO
AP
AR
KA
KL
KM
KO
KU
KYE
X



COTTLE
 KO 352/21
 21,0 cm/8¹/₄"



MASING
 KO 353/21
 21,0 cm/8¹/₄"



HOWARTH
 KO 354/21
 21,5 cm/8¹/₂"



KILLIAN
 KO 355/18
 18,0 cm/7"



KILLIAN
 KO 356/22
 22,0 cm/8³/₄"

KO

KO NASE RHINOLOGY RINOLOGIA RHINOLOGIE RINOLOGIA

Instrumente zur Nasenplastik
 Rhinoplastic Instruments
 Instrumentos para la plástica nasal
 Instruments pour la plastique nasale
 Strumenti per la plastica nasale



PIERCE
 KO 358/21
 21,0 cm/8¹/₄"



PENNINGTON-
 KO 359/21
 21,0 cm/8¹/₄"

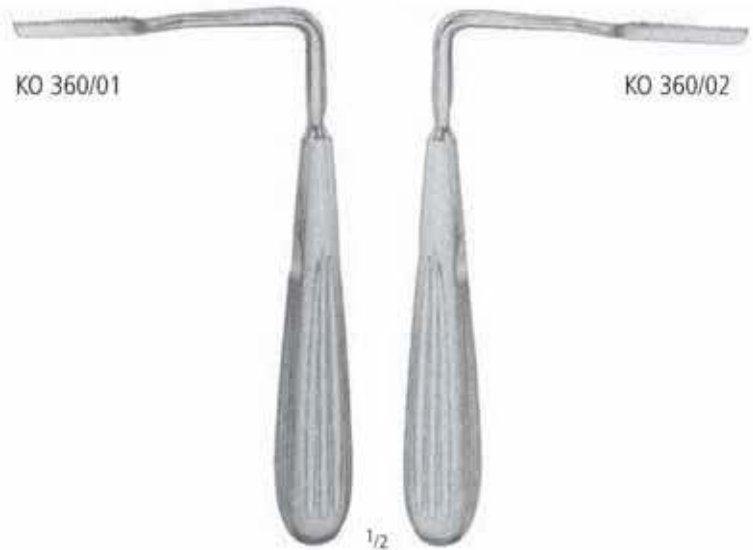

JOSEPH
 KO 360/01-02
 17,0 cm/6³/₄"



JOSEPH
 19,0 cm/7¹/₂"



KO 362/00



KO 362/01



KO 362/02

NASE RHINOLOGY RINOLOGIA RHINOLOGIE RINOLOGIA

Nasenraspeln
Nasal Rasps
Escofinas nasal
Râpes nasale
Raspe nasali



DINGMANN
15,0 cm/6"

LEWIS
18,0 cm/7"

COTTLE
KO 366/21
21,0 cm/8 1/4"

AUFRICHT
21,0 cm/8 1/4"

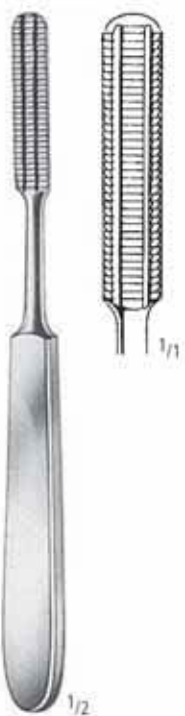

MALTZ
KO 368/18
18,0 cm/7"

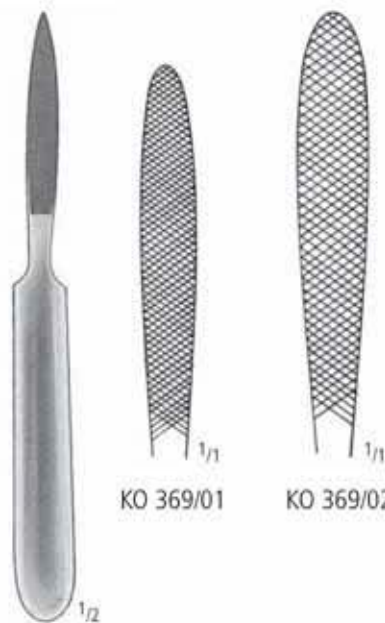

JOSEPH
16,0 cm/6 1/4"



GALLAGHER
16,0 cm/6 1/4"

AA
AB
AC
AD
AE
AF
AK
AL
AO
AP
AR
KA
KL
KM
KO
KU
KYE
X

Nasenraspeln
Nasal Rasps
Escofinas nasal
Râpes nasale
Raspe nasali



KO 375/01



KO 375/02



WIENER
18,0 cm/7"

CONVERSE
KO 376/18
18,5 cm/7 1/3"

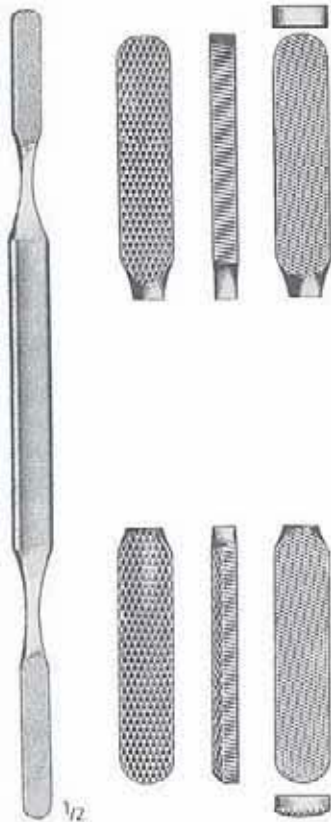

FOMON
KO 377/21
21,0 cm/8 1/4"



MASING
KO 378/21
21,0 cm/8 1/4"



MASING
KO 379/21
21,0 cm/8 1/4"

NASE RHINOLOGY RINOLOGIA RHINOLOGIE RINOLOGIA

Nasenraspeln
Nasal Rasps
Escofinas nasal
Râpes nasale
Raspe nasali



Fig. 1
KO 380/01



Fig. 2
KO 380/02



Fig. 3
KO 380/03



Fig. 4
KO 380/04



Fig. 5
KO 380/05



MILLER-COLBURN
KO 380/01-05
19,0 cm/7 1/2"



Fig. 1
KO 381/01



Fig. 2
KO 381/02



Fig. 3
KO 381/03



Fig. 4
KO 381/04



Fig. 5
KO 381/05



MILLER-COLBURN
KO 381/01-05
19,0 cm/7 1/2"

AA
AB
AC
AD
AE
AF
AK
AL
AO
AP
AR
KA
KL
KM
KO
KU
KYE
X

Nasenraspeln
Nasal Rasps
Escofinas nasal
Râpes nasale
Raspe nasali



1/2

LEWIS
KO 390/01-02
18,0 cm/7"



KO 390/01



KO 390/02



1/2

COTTLE
KO 392/21
21,0 cm/8 1/4"



1/1



1/2

FOMON
KO 395/01-05
20,0 cm/8"



KO 395/01



KO 395/02



KO 395/03



KO 395/04



KO 395/05



Felne Wundhaken
Delicate Hooks
Ganchos
Crochets très fins
Divaricatori sottili



JOSEPH
KO 400/01
15,0 cm/6"



JOSEPH
16,0 cm/6¹/₄"



KO 400/02
2,0 mm



KO 400/05
5,0 mm



KO 400/07
7,0 mm



KO 400/10
10,0 mm



COTTLE
KO 402/16
16,0 cm/6¹/₄"



FOMON
KO 403/17
17,0 cm/6³/₄"



LANGE
KO 404/22
22,0 cm/8³/₄"



FOMON
KO 405/16
16,0 cm/6¹/₄"



FREER
KO 406/15
15,0 cm/6"

AA
AB
AC
AD
AE
AF
AK
AL
AO
AP
AR
KA
KL
KM
KO
KU
KYE
X

Feine Wundhaken
Delicate Hooks
Ganchos
Crochets très fins
Divaricatori sottili

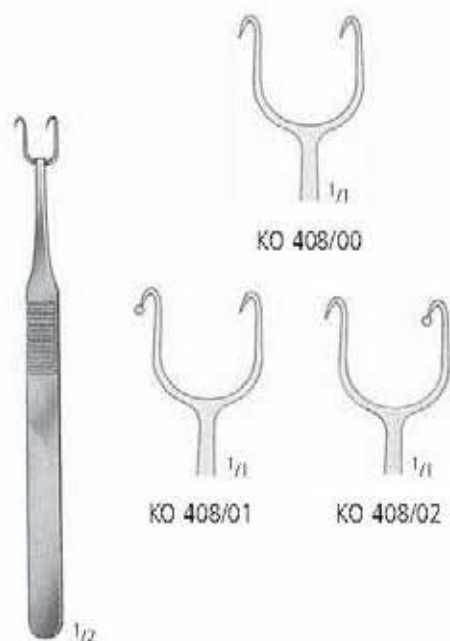

COTTLE
14,0 cm/5 1/2"



COTTLE (MILLARD)
KO 409/00



KILNER
KO 410/10



COTTLE
KO 411/14
14,0 cm/5 1/2"



COTTLE-NEIVERT
KO 412/20
20,0 cm/8"



CONVERSE
KO 413/12
12,0 cm/4 3/4"



MASING
KO 414/20
20,0 cm/8"



COTTLE
KO 415/15
15,0 cm/6"



COTTLE
KO 416/15
15,0 cm/6"

NASE RHINOLOGY RINOLOGIA RHINOLOGIE RINOLOGIA

Instrumente zur Nasenplastik
 Rhinoplastic Instruments
 Instrumentos para la plástica nasal
 Instruments pour la plastique nasale
 Strumenti per la plastica nasale



AUFRICHT (WALTER)
 KO 428/14
 13,5 cm/5 1/4"



AUFRICHT
 KO 430/45
 16,0 cm/6 1/4"



AUFRICHT
 KO 430/50
 mit Kaltlicht
 with fibre optic illumination



COTTLE
 KO 435/11
 11,0 cm/4 1/3"



YANKAUER



AA
 AB
 AC
 AD
 AE
 AF
 AK
 AL
 AO
 AP
 AR
 KA
 KL
 KM
KO
 KU
 KYE
 X

Küretten
 Sharp Curettes
 Curetas cortantes
 Curettes tranchantes
 Curette taglienti

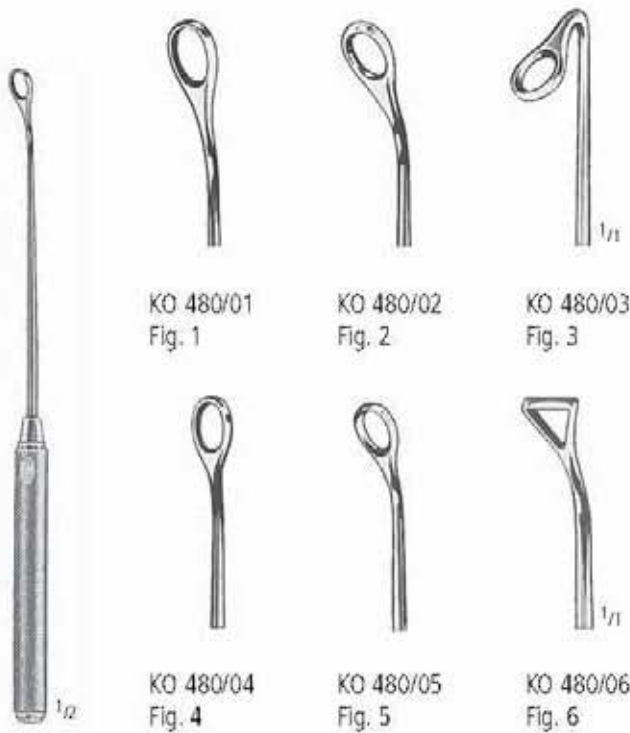

COAKLEY
 KO 480/01-06
 17,0 cm/6³/₄"



FAULKNER
 KO 482/21
 21,0 cm/8¹/₄"



SEWALL
 KO 485/20
 20,0 cm/8"

Flach- und Hohlmeißel
Chisels and Gouges
Cinceles y Gubias
Ciseaux-burins et Gouges
Scalpelli e Sgorbie



FREER
KO 602/04
16,0 cm/6 1/4"



FREER
KO 603/04
16,0 cm/6 1/4"



WEST
KO 604/04
16,0 cm/6 1/4"



WEST
KO 605/04
16,0 cm/6 1/4"



FREER
KO 606/06
15,0 cm/6"



BALLENGER
16,0 cm/6 1/4"



KILLIAN
KO 608/05
17,0 cm/6 3/4"



KILLIAN-CLAUS
KO 609/05
17,0 cm/6 3/4"

AA
AB
AC
AD
AE
AF
AK
AL
AO
AP
AR
KA
KL
KM
KO
KU
KYE
X

Osteotome und Flachmeißel
 Osteotomes and Chisels
 Osteótomos y Cinceles
 Ostéotomes et Ciseaux-burins
 Osteotomi e Scalpelli

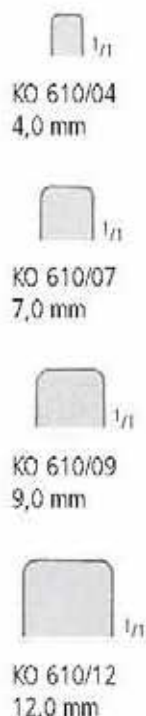

COTTLE
18,0 cm/7"



COTTLE
KO 611/06
18,0 cm/7"



COTTLE
KO 612/06
18,0 cm/7"



COTTLE
18,0 cm/7"

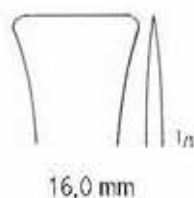
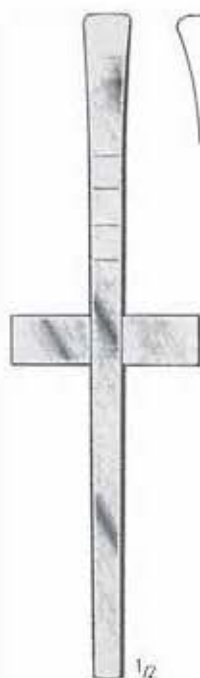

COTTLE
KO 614/16
18,0 cm/7"



COTTLE
KO 615/16
18,0 cm/7"

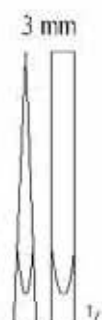

SCHIELE
KO 616/03
18,5 cm/7 1/3"

NASE RHINOLOGY RINOLOGIA RHINOLOGIE RINOLOGIA

Osteotome und Flachmeißel
 Osteotomes and Chisels
 Osteótomos y Cinceles
 Ostéotomes et Ciseaux-burins
 Osteotomi e Scalpelli



KO 635/03
3,0 mm



KO 635/04
4,5 mm



WALTER
19,0 cm/7¹/₂"



KO 636/03
3,0 mm



KO 636/04
4,0 mm



KO 636/07
7,0 mm



KO 636/09
9,0 mm



KO 636/12
12,0 mm



SHEEHAN
17,0 cm/6³/₄"



RUBIN
18,0 cm/7"



KO 638/10
10,0 mm



KO 638/12
12,0 mm



KO 638/14
14,0 mm



FOMON
17,0 cm/6³/₄"



KO 639/04
4,0 mm



KO 639/05
5,0 mm



KO 639/06
6,0 mm



KO 639/07
7,0 mm



CINELLI
18,0 cm/7"



KO 640/10
10,0 mm



KO 640/12
12,0 mm



KO 640/14
14,0 mm



KO 640/16
16,0 mm

AA
AB
AC
AD
AE
AF
AK
AL
AO
AP
AR
KA
KL
KM
KO
KU
KYE
X

Osteotome und Flachmeißel
 Osteotomes and Chisels
 Osteótomos y Cinceles
 Ostéotomes et Ciseaux-burins
 Osteotomi e Scalpelli



MASING
 KO 643/00
 17,5 cm/7"



MASING
 KO 643/01
 17,5 cm/7"



MASING
 KO 643/02
 17,5 cm/7"



SILVER
 KO 644/00
 18,0 cm/7"



SILVER
 KO 644/01
 18,0 cm/7"

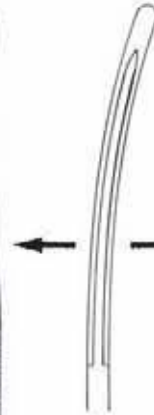

SILVER
 KO 644/02
 18,0 cm/7"



NEIVERT
 KO 645/00
 20,0 cm/8"



ANDERSON-NEIVERT
 KO 645/01
 20,0 cm/8"



ANDERSON-NEIVERT
 KO 645/02
 20,0 cm/8"



CONVERSE
 KO 646/01



CONVERSE
 KO 646/02



CONVERSE
 KO 646/00
 19,0 cm/7 1/2"



OBWEGESER
 KO 647/02
 18,5 cm/7 1/3"

Ringmesser
Adenoid Curettes
Cuchillos para vegetaciones adenoides
Couteaux à végétations adénoïdes
Coltelli per vegetazioni adenoides

AA
AB
AC
AD
AE
AF
AK
AL
AO
AP
AR
KA
KL
KM
KU
KYE
X



KO 702/01



KO 702/02



KO 702/03



KO 702/04



BECKMANN
KO 700/01-06
22,0 cm/8³/₄"



KO 700/01
KO 701/01



KO 700/03
KO 701/03



KO 700/05
KO 701/05



KO 700/02
KO 701/02



KO 700/04
KO 701/04



KO 700/06
KO 701/06



BECKMANN (NEGUS)
KO 701/01-06
22,0 cm/8³/₄"



BARNHILL
KO 702/01-04
22,0 cm/8³/₄"

Ringmesser, Tonsillotome
 Adenoid Currettes, Adenotomes
 Cuchillos para vegetaciones adenoides, Adenótomos
 Couteaux à végétations adénoïdes, Adénotomes
 Coltelli per vegetazioni adenoidee, Adenotomi



KO 705/01



KO 705/02



KO 705/03



KO 705/04



ST. CLAIR-THOMPSON
 KO 705/01-04
 21,0 cm/8 1/4"



LA FORCE
 25,0 cm/10"



1/1

Fig. 1

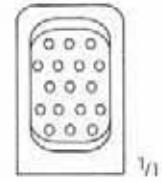

1/1



1/1

Fig. 2

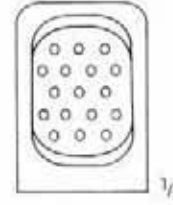

1/1



1/1

Fig. 3

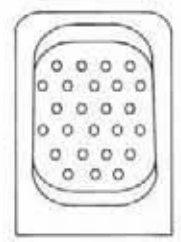

1/1

mit ungelochter Klinge
 with unperforated blade
 con hoja no perforada
 à lame non-perforée
 con lama non perforata

mit gelochter Klinge
 with perforated blade
 con hoja perforada
 à lame perforée
 con lama perforata

Fig. 1 KO 710/01
 Fig. 2 KO 710/02
 Fig. 3 KO 710/03

KO 712/01
 KO 712/02
 KO 712/03

Ersatzklingen
 Spare blades
 Hojas repuesto
 Lames de rechange
 Lami da ricambio

Fig. 1 KO 711/01
 Fig. 2 KO 711/02
 Fig. 3 KO 711/03

KO 713/01
 KO 713/02
 KO 713/03

Septumrichtzangen
 Septum Straightening Forceps
 Pinzas para enderezar el tabique nasal
 Pincès pour la cloison nasale
 Pinze per raddrizzare il setto nasale



ASCH
 KO 750/23
 23,0 cm/9"



WALSHAM
 23,0 cm/9"



KO 751/00



KO 751/01



KO 751/02

AA
 AB
 AC
 AD
 AE
 AF
 AG
 AH
 AI
 AJ
 AK
 AL
 AM
 AN
 AO
 AP
 AQ
 AR
 AS
 AT
 AU
 AV
 AW
 AX
 AY
 AZ
 BA
 BB
 BC
 BD
 BE
 BF
 BG
 BH
 BI
 BJ
 BK
 BL
 BM
 BN
 BO
 BP
 BQ
 BR
 BS
 BT
 BU
 BV
 BW
 BX
 BY
 BZ
 CA
 CB
 CC
 CD
 CE
 CF
 CG
 CH
 CI
 CJ
 CK
 CL
 CM
 CN
 CO
 CP
 CQ
 CR
 CS
 CT
 CU
 CV
 CW
 CX
 CY
 CZ
 DA
 DB
 DC
 DD
 DE
 DF
 DG
 DH
 DI
 DJ
 DK
 DL
 DM
 DN
 DO
 DP
 DQ
 DR
 DS
 DT
 DU
 DV
 DW
 DX
 DY
 DZ
 EA
 EB
 EC
 ED
 EE
 EF
 EG
 EH
 EI
 EJ
 EK
 EL
 EM
 EN
 EO
 EP
 EQ
 ER
 ES
 ET
 EU
 EV
 EW
 EX
 EY
 EZ
 FA
 FB
 FC
 FD
 FE
 FF
 FG
 FH
 FI
 FJ
 FK
 FL
 FM
 FN
 FO
 FP
 FQ
 FR
 FS
 FT
 FU
 FV
 FW
 FX
 FY
 FZ
 GA
 GB
 GC
 GD
 GE
 GF
 GG
 GH
 GI
 GJ
 GK
 GL
 GM
 GN
 GO
 GP
 GQ
 GR
 GS
 GT
 GU
 GV
 GW
 GX
 GY
 GZ
 HA
 HB
 HC
 HD
 HE
 HF
 HG
 HH
 HI
 HJ
 HK
 HL
 HM
 HN
 HO
 HP
 HQ
 HR
 HS
 HT
 HU
 HV
 HW
 HX
 HY
 HZ
 IA
 IB
 IC
 ID
 IE
 IF
 IG
 IH
 II
 IJ
 IK
 IL
 IM
 IN
 IO
 IP
 IQ
 IR
 IS
 IT
 IU
 IV
 IW
 IX
 IY
 IZ
 JA
 JB
 JC
 JD
 JE
 JF
 JG
 JH
 JI
 JJ
 JK
 JL
 JM
 JN
 JO
 JP
 JQ
 JR
 JS
 JT
 JU
 JV
 JW
 JX
 JY
 JZ
 KA
 KB
 KC
 KD
 KE
 KF
 KG
 KH
 KI
 KJ
 KK
 KL
 KM
 KN
 KO
 KP
 KQ
 KR
 KS
 KT
 KU
 KV
 KW
 KX
 KY
 KZ
 LA
 LB
 LC
 LD
 LE
 LF
 LG
 LH
 LI
 LJ
 LK
 LL
 LM
 LN
 LO
 LP
 LQ
 LR
 LS
 LT
 LU
 LV
 LW
 LX
 LY
 LZ
 MA
 MB
 MC
 MD
 ME
 MF
 MG
 MH
 MI
 MJ
 MK
 ML
 MM
 MN
 MO
 MP
 MQ
 MR
 MS
 MT
 MU
 MV
 MW
 MX
 MY
 MZ
 NA
 NB
 NC
 ND
 NE
 NF
 NG
 NH
 NI
 NJ
 NK
 NL
 NM
 NN
 NO
 NP
 NQ
 NR
 NS
 NT
 NU
 NV
 NW
 NX
 NY
 NZ
 OA
 OB
 OC
 OD
 OE
 OF
 OG
 OH
 OI
 OJ
 OK
 OL
 OM
 ON
 OO
 OP
 OQ
 OR
 OS
 OT
 OU
 OV
 OW
 OX
 OY
 OZ
 PA
 PB
 PC
 PD
 PE
 PF
 PG
 PH
 PI
 PJ
 PK
 PL
 PM
 PN
 PO
 PP
 PQ
 PR
 PS
 PT
 PU
 PV
 PW
 PX
 PY
 PZ
 QA
 QB
 QC
 QD
 QE
 QF
 QG
 QH
 QI
 QJ
 QK
 QL
 QM
 QN
 QO
 QP
 QQ
 QR
 QS
 QT
 QU
 QV
 QW
 QX
 QY
 QZ
 RA
 RB
 RC
 RD
 RE
 RF
 RG
 RH
 RI
 RJ
 RK
 RL
 RM
 RN
 RO
 RP
 RQ
 RR
 RS
 RT
 RU
 RV
 RW
 RX
 RY
 RZ
 SA
 SB
 SC
 SD
 SE
 SF
 SG
 SH
 SI
 SJ
 SK
 SL
 SM
 SN
 SO
 SP
 SQ
 SR
 SS
 ST
 SU
 SV
 SW
 SX
 SY
 SZ
 TA
 TB
 TC
 TD
 TE
 TF
 TG
 TH
 TI
 TJ
 TK
 TL
 TM
 TN
 TO
 TP
 TQ
 TR
 TS
 TT
 TU
 TV
 TW
 TX
 TY
 TZ
 UA
 UB
 UC
 UD
 UE
 UF
 UG
 UH
 UI
 UJ
 UK
 UL
 UM
 UN
 UO
 UP
 UQ
 UR
 US
 UT
 UY
 UZ
 VA
 VB
 VC
 VD
 VE
 VF
 VG
 VH
 VI
 VJ
 VK
 VL
 VM
 VN
 VO
 VP
 VQ
 VR
 VS
 VT
 VU
 VV
 VW
 VX
 VY
 VZ
 WA
 WB
 WC
 WD
 WE
 WF
 WG
 WH
 WI
 WJ
 WK
 WL
 WM
 WN
 WO
 WP
 WQ
 WR
 WS
 WT
 WU
 WV
 WW
 WX
 WY
 WZ
 XA
 XB
 XC
 XD
 XE
 XF
 XG
 XH
 XI
 XJ
 XK
 XL
 XM
 XN
 XO
 XP
 XQ
 XR
 XS
 XT
 XU
 XV
 XW
 XX
 XY
 XZ
 YA
 YB
 YC
 YD
 YE
 YF
 YG
 YH
 YI
 YJ
 YK
 YL
 YM
 YN
 YO
 YP
 YQ
 YR
 YS
 YT
 YU
 YV
 YW
 YX
 YZ
 ZA
 ZB
 ZC
 ZD
 ZE
 ZF
 ZG
 ZH
 ZI
 ZJ
 ZK
 ZL
 ZM
 ZN
 ZO
 ZP
 ZQ
 ZR
 ZS
 ZT
 ZU
 ZV
 ZW
 ZX
 ZY
 ZZ

Instrumente zur Nasenplastik
 Rhinoplastic Instruments
 Instrumentos para la plástica nasal
 Instruments pour la plastique nasale
 Strumenti per la plastica nasale



RUBIN
 KO 753/20
 20,0 cm/8"



KRESSNER
 20,0 cm/8"



KO 754/60
 2,5 x 60 mm



KO 754/70
 4 x 70 mm



KO 754/75
 5 x 75 mm

KO 755/00 = KO 755/01
 + KO 755/02



KO 755/01

KO 755/02

Knorpelquetscher
 Cartilage crusher
 Trituradora de sustancia cartilaginosa
 Presse pour matière cartilagineuse
 Trita cartilagine



COTTLE
 KO 756/00



BOIES
 KO 757/18
 18,0 cm/7"



GOLDMANN
 KO 758/20
 20,0 cm/8"

Hämmer
Mallets
Martillos
Maillets
Martelli



Ø 25,0 mm
140 g
mit auswechselbaren Backen
with interchangeable discs
con tapas intercambiables
avec plaques interchangeable
con placche intercambiabili

KO 800/18
18,0 cm/7"

KO 800/99
Ferozellbacken allein, paarweise
Ferozell Faces only, pair
Tapas de Ferozell sueltas, par
Plaques en Ferozell seules, paire
Placche in Ferozell sole, a pala



Ø 30,0 mm
240 g

COTTLE
KO 801/19
19,0 cm/7 1/2"

AA
AB
AC
AD
AE
AF
AK
AL
AO
AP
AR
KA
KL
KM
KU
KYE
X

KO

VERSCHIEDENES
VARIOUS ITEMS
DIVERSOS ARTICULOS
ARTICLES DIVERS
ARTICOLI DIVERSI

KU

nopa[®] instruments





Ø x h		
40 x 19 mm	0,05 l	KU 300/04
61 x 30 mm	0,07 l	KU 300/06
80 x 40 mm	0,14 l	KU 300/08
116 x 50 mm	0,35 l	KU 300/11
128 x 55 mm	0,45 l	KU 300/12
147 x 65 mm	0,70 l	KU 300/14



KU 301/01 = 0,25 l
KU 301/02 = 0,50 l
KU 301/03 = 1,00 l
KU 301/04 = 2,00 l



L = 170 mm	KU 302/17
L = 250 mm	KU 302/25
L = 275 mm	KU 302/27



KU 303/00
 $\varnothing = 65 \text{ mm}$



KU 304/50 = 50 x 25 x 4,5 mm
 KU 304/65 = 65 x 42 x 8,0 mm
 KU 304/75 = 75 x 25 x 4,5 mm



KU 306/15 = 150 x 95 x 13 mm



l x b x h	
230 x 155 x 30 mm	KU 307/23
300 x 175 x 30 mm	KU 307/30
300 x 175 x 40 mm	KU 308/30
350 x 240 x 36 mm	KU 308/35
400 x 300 x 50 mm	KU 308/50



l x b x h	
210 x 160 x 10 mm	KU 309/21
240 x 180 x 10 mm	KU 309/24
310 x 150 x 10 mm	KU 309/31
310 x 210 x 10 mm	KU 310/31
350 x 240 x 10 mm	KU 310/35
400 x 270 x 20 mm	KU 310/40
420 x 280 x 10 mm	KU 310/42



Ø x h	l	
165 x 60 mm	0,75	KU 311/16
175 x 70 mm	1,00	KU 311/17
220 x 80 mm	2,00	KU 311/22
225 x 90 mm	2,50	KU 311/23
240 x 110 mm	3,00	KU 311/24
275 x 115 mm	4,50	KU 311/27
290 x 125 mm	6,00	KU 311/29
310 x 120 mm	6,00	KU 311/31
345 x 125 mm	8,50	KU 311/34
380 x 130 mm	11,00	KU 311/38



l x b x h	
16,5 x 9,0 x 3,5 cm	KU 312/16
20,0 x 10,0 x 5,0 cm	KU 312/20
22,0 x 15,0 x 5,0 cm	KU 312/22
26,0 x 15,0 x 5,0 cm	KU 312/26
30,5 x 20,5 x 5,0 cm	KU 312/30



Ø x h	
30 x 90 mm	KU 314/09
50 x 100 mm	KU 314/10
50 x 130 mm	KU 314/13
50 x 175 mm	KU 314/17
75 x 100 mm	KU 315/10
75 x 130 mm	KU 315/13
75 x 175 mm	KU 315/17



MAYO
KU 318/14
14,0 cm/5 1/2"



MAYO
KU 320/14
14,0 cm/5 1/2"



CHEATLE
KU 321/27
27,0 cm/10 1/2"



ROGGE
KU 322/23
23,0 cm/9"



PYE-SMITH (HARRISON)
KU 323/25 25,0 cm/10"
KU 323/30 30,0 cm/12"



KU 325/18
18,0 cm/7"

container system
container system
sistema de contenedor
système de conteneur
sistema del contenitore

KYE

nopa[®] instruments

Unser komplettes Container Programm finden Sie in unserem Katalog „Container System“.

For our complete range of sterilizing containers kindly refer to our catalogue "Container system".

Para nuestro gama completa de contenedores, por favor consulte nuestro catálogo de "Sistema de contenedor".

Pour notre gamme complet des conteneurs, consultez notre catalogue „Système de conteneur“.

Per nostro assortimento completo di contenitore, consultare il nostro catalogo "Sistema del Contenitore".



Erklärung zu unseren Symbolen • Explanation of our symbols • Explicación de nuestros símbolos
 • Explication de nos figures • Spiegazione dei nostri simboli

Wanne • Bottom • Fondo • Fond • Fondo



Wanne nicht gelocht
 Bottom not perforated
 Fondo no perforado
 Fond non poinçonné
 Fondo non perforato



Wanne gelocht
 Bottom perforated
 Fondo perforado
 Fond poinçonné
 Fondo perforato

Deckel • Lid • Tapa • Couvercle • Coperchio



Deckel gelocht
 Lid perforated
 Tapa perforada
 Couvercle poinçonné
 Coperchio perforato



Sicherheitsdeckel
 Safety lid
 Tapa de seguridad
 Couvercle de sécurité
 Coperchio di sicurezza



Deckel nicht gelocht
 Lid not perforated
 Tapa no perforada
 Couvercle non poinçonné
 Coperchio non perforato

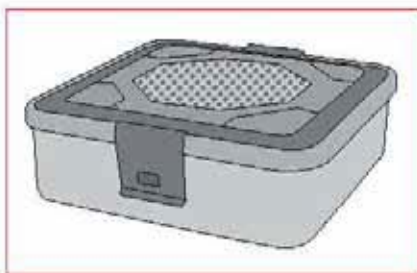

Zur Verwendung mit Sterilisationscontainern
 For use with sterilization containers
 Por uso con contenedores de esterilización
 Pour l'usage avec des conteneurs de stérilisation
 Per l'uso con contenitori di sterilizzazione

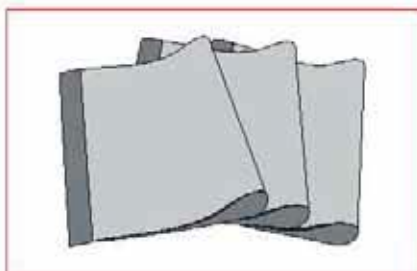

Zur Verwendung mit Weichverpackung
 For the use with soft packaging materials
 Por uso con envase blando
 Pour l'usage avec des emballages mous
 Per l'uso con imballaggio blando

1/1 Container

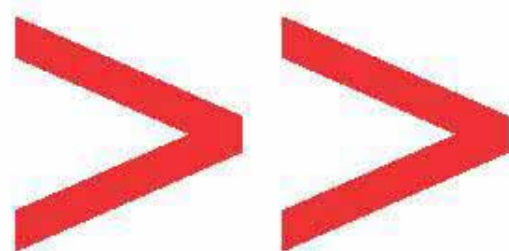



Nur Deckel farbig
Lid colored only
Solamente tapas en diferentes colores
Couvercle de couleur seulement
Solo coperchio colorato

L(mm)	B(mm)	H(mm)						
580	280	100	KYE 200/51	KYE 200/52	KYE 200/53	KYE 200/54	KYE 200/55	KYE 200/56
580	280	135	KYE 200/61	KYE 200/62	KYE 200/63	KYE 200/64	KYE 200/65	KYE 200/66
580	280	150	KYE 200/71	KYE 200/72	KYE 200/73	KYE 200/74	KYE 200/75	KYE 200/76
580	280	200	KYE 200/81	KYE 200/82	KYE 200/83	KYE 200/84	KYE 200/85	KYE 200/86
580	280	260	KYE 200/91	KYE 200/92	KYE 200/93	KYE 200/94	KYE 200/95	KYE 200/96



Nur Deckel farbig
Lid colored only
Solamente tapas en diferentes colores
Couvercle de couleur seulement
Solo coperchio colorato

L(mm)	B(mm)	H(mm)						
580	280	100	KYE 204/51	KYE 204/52	KYE 204/53	KYE 204/54	KYE 204/55	KYE 204/56
580	280	135	KYE 204/61	KYE 204/62	KYE 204/63	KYE 204/64	KYE 204/65	KYE 204/66
580	280	150	KYE 204/71	KYE 204/72	KYE 204/73	KYE 204/74	KYE 204/75	KYE 204/76
580	280	200	KYE 204/81	KYE 204/82	KYE 204/83	KYE 204/84	KYE 204/85	KYE 204/86
580	280	260	KYE 204/91	KYE 204/92	KYE 204/93	KYE 204/94	KYE 204/95	KYE 204/96

Wanne gelocht
Bottom perforated
Fondo perforado
Fond poinçonné
Fondo perforato



L(mm)	B(mm)	H(mm)	
580	280	100	KYE 285/10
580	280	135	KYE 285/13
580	280	150	KYE 285/15
580	280	200	KYE 285/20
580	280	260	KYE 285/26





Wanne nicht gelocht
Bottom not perforated
Fondo no perforado
Fond non poinçonné
Fondo non perforato



L(mm)	B(mm)	H(mm)	
580	280	100	KYE 287/10
580	280	135	KYE 287/13
580	280	150	KYE 287/15
580	280	200	KYE 287/20
580	280	260	KYE 287/26





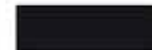

Deckel gelocht
Lid perforated
Tapa perforada
Couvercle poinçonné
Coperchio perforato



L(mm)	B(mm)						
580	280						
		KYE 280/51	KYE 280/52	KYE 280/53	KYE 280/54	KYE 280/55	KYE 280/56

Sicherheitsdeckel
Safety lid
Tapa de seguridad
Couvercle de sécurité
Coperchio di sicurezza



L(mm)	B(mm)						
580	280						
		KYE 281/51	KYE 281/52	KYE 281/53	KYE 281/54	KYE 281/55	KYE 281/56

Deckel nicht gelocht
Lid not perforated
Tapa no perforada
Couvercle non poinçonné
Coperchio non perforato



L(mm)	B(mm)						
580	280						
		KYE 289/51	KYE 289/52	KYE 289/53	KYE 289/54	KYE 289/55	KYE 289/56

AA
AB
AC
AD
AE
AF
AK
AL
AO
AP
AR
KA
KL
KM
KO
KU
X
X

KYE



L(mm)	B(mm)	H(mm)	
485	255	30	SK 305/03
485	255	50	SK 305/05
485	255	70	SK 305/07
485	255	100	SK 305/10
540	255	30	SK 307/03
540	255	50	SK 307/05
540	255	70	SK 307/07
540	255	100	SK 307/10



L(mm)	B(mm)
545	255



SK 307/61



L(mm)	B(mm)
485	255
540	255



SK 305/50
SK 307/50



L(mm)	B(mm)	H(mm)
545	255	30



SK 307/62



L(mm)	B(mm)	H(mm)
510	250	130



SK 307/71



L(mm)	B(mm)	H(mm)
510	250	130



SK 307/72

3/4 Container

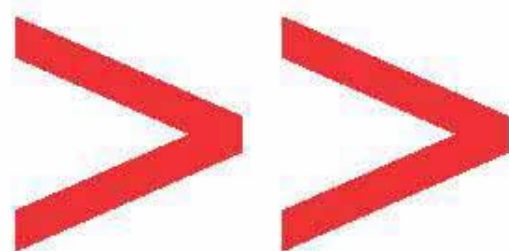



Nur Deckel farbig
Lid colored only
Solamente tapas en diferentes colores
Couvercle de couleur seulement
Solo coperchio colorato

L(mm)	B(mm)	H(mm)						
465	280	100	KYE 202/01	KYE 202/02	KYE 202/03	KYE 202/04	KYE 202/05	KYE 202/06
465	280	135	KYE 202/11	KYE 202/12	KYE 202/13	KYE 202/14	KYE 202/15	KYE 202/16
465	280	150	KYE 202/21	KYE 202/22	KYE 202/23	KYE 202/24	KYE 202/25	KYE 202/26



Nur Deckel farbig
Lid colored only
Solamente tapas en diferentes colores
Couvercle de couleur seulement
Solo coperchio colorato

L(mm)	B(mm)	H(mm)						
465	280	100	KYE 205/01	KYE 205/02	KYE 205/03	KYE 205/04	KYE 205/05	KYE 205/06
465	280	135	KYE 205/11	KYE 205/12	KYE 205/13	KYE 205/14	KYE 205/15	KYE 205/16
465	280	150	KYE 205/21	KYE 205/22	KYE 205/23	KYE 205/24	KYE 205/25	KYE 205/26

Wanne gelocht
Bottom perforated
Fondo perforado
Fond poinçonné
Fondo perforato



L(mm)	B(mm)	H(mm)	
465	280	100	KYE 282/10
465	280	135	KYE 282/13
465	280	150	KYE 282/15





Wanne nicht gelocht
Bottom not perforated
Fondo no perforado
Fond non poinçonné
Fondo non perforato



L(mm)	B(mm)	H(mm)	
465	280	100	KYE 283/10
465	280	135	KYE 283/13
465	280	150	KYE 283/15



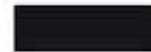

Deckel gelocht
Lid perforated
Tapa perforada
Couvercle poinçonné
Coperchio perforato



L(mm)	B(mm)						
465	280						
		KYE 280/61	KYE 280/62	KYE 280/63	KYE 280/64	KYE 280/65	KYE 280/66

Sicherheitsdeckel
Safety lid
Tapa de seguridad
Couvercle de sécurité
Coperchio di sicurezza



L(mm)	B(mm)						
465	280						
		KYE 281/61	KYE 281/62	KYE 281/63	KYE 281/64	KYE 281/65	KYE 281/66

Deckel nicht gelocht
Lid not perforated
Tapa no perforada
Couvercle non poinçonné
Coperchio non perforato



L(mm)	B(mm)						
465	280						
		KYE 289/61	KYE 289/62	KYE 289/63	KYE 289/64	KYE 289/65	KYE 289/66

AA
AB
AC
AD
AE
AF
AK
AL
AO
AP
AR
KA
KL
KM
KO
KU
X
KYE



L(mm)	B(mm)	H(mm)	
405	255	30	SK 205/03
405	255	50	SK 205/05
405	255	70	SK 205/07
405	255	100	SK 205/10

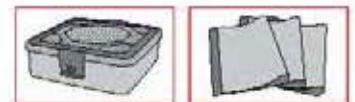

L(mm)	B(mm)	
405	255	SK 205/50



L(mm)	B(mm)	
405	255	SK 205/61

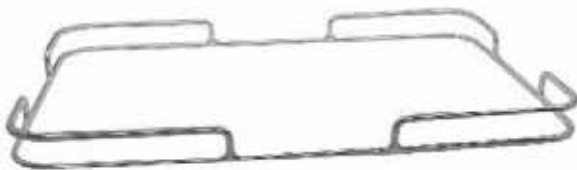

L(mm)	B(mm)	H(mm)	
405	255	30	SK 205/62



L(mm)	B(mm)	H(mm)	
405	250	130	SK 205/71







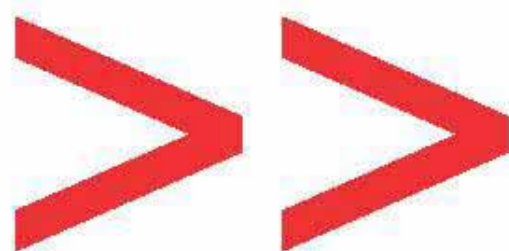

L(mm)	B(mm)	H(mm)	
405	250	130	SK 205/72

1/2 Container









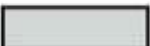

Nur Deckel farbig
Lid colored only
Solamente tapas en diferentes colores
Couvercle de couleur seulement
Solo coperchio colorato

L(mm)	B(mm)	H(mm)						
285	280	100	KYE 200/01	KYE 200/02	KYE 200/03	KYE 200/04	KYE 200/05	KYE 200/06
285	280	135	KYE 200/11	KYE 200/12	KYE 200/13	KYE 200/14	KYE 200/15	KYE 200/16
285	280	150	KYE 200/21	KYE 200/22	KYE 200/23	KYE 200/24	KYE 200/25	KYE 200/26
285	280	200	KYE 200/31	KYE 200/32	KYE 200/33	KYE 200/34	KYE 200/35	KYE 200/36
285	280	260	KYE 200/41	KYE 200/42	KYE 200/43	KYE 200/44	KYE 200/45	KYE 200/46



Nur Deckel farbig
Lid colored only
Solamente tapas en diferentes colores
Couvercle de couleur seulement
Solo coperchio colorato

L(mm)	B(mm)	H(mm)						
285	280	100	KYE 204/01	KYE 204/02	KYE 204/03	KYE 204/04	KYE 204/05	KYE 204/06
285	280	135	KYE 204/11	KYE 204/12	KYE 204/13	KYE 204/14	KYE 204/15	KYE 204/16
285	280	150	KYE 204/21	KYE 204/22	KYE 204/23	KYE 204/24	KYE 204/25	KYE 204/26
285	280	200	KYE 204/31	KYE 204/32	KYE 204/33	KYE 204/34	KYE 204/35	KYE 204/36
285	280	260	KYE 204/41	KYE 204/42	KYE 204/43	KYE 204/44	KYE 204/45	KYE 204/46

Wanne gelocht
Bottom perforated
Fondo perforado
Fond poinçonné
Fondo perforato



L(mm)	B(mm)	H(mm)	
285	280	100	KYE 284/10
285	280	135	KYE 284/13
285	280	150	KYE 284/15
285	280	200	KYE 284/20
285	280	260	KYE 284/26





Wanne nicht gelocht
Bottom not perforated
Fondo no perforado
Fond non poinçonné
Fondo non perforato



L(mm)	B(mm)	H(mm)	
285	280	100	KYE 286/10
285	280	135	KYE 286/13
285	280	150	KYE 286/15
285	280	200	KYE 286/20
285	280	260	KYE 286/26



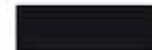

Deckel gelocht
Lid perforated
Tapa perforada
Couvercle poinçonné
Coperchio perforato



L(mm)	B(mm)						
285	280						
		KYE 280/01	KYE 280/02	KYE 280/03	KYE 280/04	KYE 280/05	KYE 280/06

Sicherheitsdeckel
Safety lid
Tapa de seguridad
Couvercle de sécurité
Coperchio di sicurezza



L(mm)	B(mm)						
285	280						
		KYE 281/01	KYE 281/02	KYE 281/03	KYE 281/04	KYE 281/05	KYE 281/06

Deckel nicht gelocht
Lid not perforated
Tapa no perforada
Couvercle non poinçonné
Coperchio non perforato



L(mm)	B(mm)						
285	280						
		KYE 289/01	KYE 289/02	KYE 289/03	KYE 289/04	KYE 289/05	KYE 289/06

AA
AB
AC
AD
AE
AF
AK
AL
AO
AP
AR
KA
KL
KM
KO
KU
X
KYE



L(mm)	B(mm)	H(mm)	
255	245	30	SK 105/03
255	245	50	SK 105/05
255	245	70	SK 105/07
255	245	100	SK 105/10



L(mm)	B(mm)	
255	245	SK 105/50

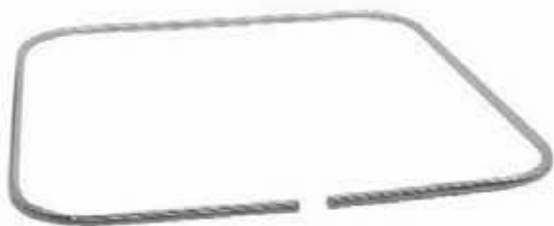

L(mm)	B(mm)	
255	255	SK 105/61



L(mm)	B(mm)	H(mm)	
255	255	30	SK 105/62



L(mm)	B(mm)	H(mm)	
255	245	130	SK 105/71

Flach Container Flat Container

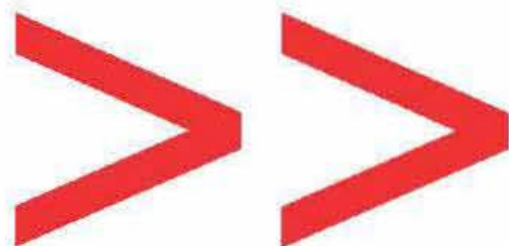



Nur Deckel farbig
Lid colored only
Solamente tapas en diferentes colores
Couvercle de couleur seulement
Solo coperchio colorato

L(mm)	B(mm)	H(mm)						
285	280	55	KYE 190/01	KYE 190/02	KYE 190/03	KYE 190/04	KYE 190/05	KYE 190/06
285	280	85	KYE 195/01	KYE 195/02	KYE 195/03	KYE 195/04	KYE 195/05	KYE 195/06



Nur Deckel farbig
Lid colored only
Solamente tapas en diferentes colores
Couvercle de couleur seulement
Solo coperchio colorato

L(mm)	B(mm)	H(mm)						
285	280	55	KYE 196/01	KYE 196/02	KYE 196/03	KYE 196/04	KYE 196/05	KYE 196/06
285	280	85	KYE 198/01	KYE 198/02	KYE 198/03	KYE 198/04	KYE 198/05	KYE 198/06

Wanne gelocht
Bottom perforated
Fondo perforado
Fond poinçonné
Fondo perforato



L(mm)	B(mm)	H(mm)	
285	280	55	KYE 284/05
285	280	85	KYE 284/08



Wanne nicht gelocht
Bottom not perforated
Fondo no perforado
Fond non poinçonné
Fondo non perforato



L(mm)	B(mm)	H(mm)	
285	280	55	KYE 286/05
285	280	85	KYE 286/08

Deckel gelocht
Lid perforated
Tapa perforada
Couvercle poinçonné
Coperchio perforato

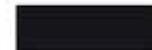

L(mm)	B(mm)						
285	280						
		KYE 280/11	KYE 280/12	KYE 280/13	KYE 280/14	KYE 280/15	KYE 280/16

Deckel nicht gelocht
Lid not perforated
Tapa no perforada
Couvercle non poinçonné
Coperchio non perforato



L(mm)	B(mm)						
285	280						
		KYE 289/11	KYE 289/12	KYE 289/13	KYE 289/14	KYE 289/15	KYE 289/16

AA
AB
AC
AD
AE
AF
AK
AL
AO
AP
AR
KA
KL
KM
KO
KU
X
KYE



L(mm)	B(mm)	H(mm)	
255	245	30	SK 105/03
255	245	50	SK 105/05



L(mm)	B(mm)	
255	245	SK 105/50



L(mm)	B(mm)	
255	255	SK 105/61



L(mm)	B(mm)	H(mm)	
255	255	30	SK 105/62



Klein Set Container Small Set Container

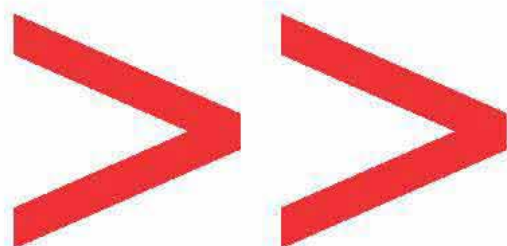



Nur Deckel farbig
Lid colored only
Solamente tapas en diferentes colores
Couvercle de couleur seulement
Solo coperchio colorato

L(mm)	B(mm)	H(mm)						
300	140	40	KYE 350/01	KYE 350/02	KYE 350/03	KYE 350/04	KYE 350/05	KYE 350/06
300	140	70	KYE 351/01	KYE 351/02	KYE 351/03	KYE 351/04	KYE 351/05	KYE 351/06
300	140	100	KYE 352/01	KYE 352/02	KYE 352/03	KYE 352/04	KYE 352/05	KYE 352/06



Nur Deckel farbig
Lid colored only
Solamente tapas en diferentes colores
Couvercle de couleur seulement
Solo coperchio colorato

L(mm)	B(mm)	H(mm)						
300	140	40	KYE 353/01	KYE 353/02	KYE 353/03	KYE 353/04	KYE 353/05	KYE 353/06
300	140	70	KYE 354/01	KYE 354/02	KYE 354/03	KYE 354/04	KYE 354/05	KYE 354/06
300	140	100	KYE 355/01	KYE 355/02	KYE 355/03	KYE 355/04	KYE 355/05	KYE 355/06

AA
AB
AC
AD
AE
AF
AK
AL
AO
AP
AR
KA
KL
KM
KO
KU
X
KYE



L(mm)	B(mm)	H(mm)	
300	140	40	KYE 360/04
300	140	70	KYE 360/07
300	140	100	KYE 360/10



L(mm)	B(mm)	H(mm)	
300	140	40	KYE 361/04
300	140	70	KYE 361/07
300	140	100	KYE 361/10



L(mm)	B(mm)
300	140

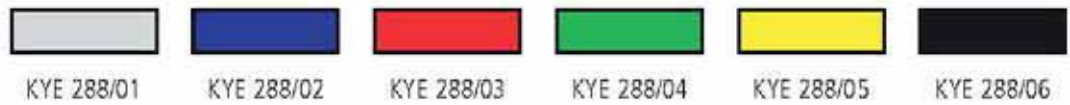

KYE 288/01 KYE 288/02 KYE 288/03 KYE 288/04 KYE 288/05 KYE 288/06



L(mm)	B(mm)
300	140

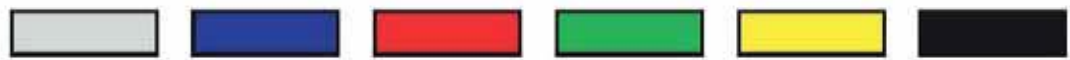

KYE 289/81 KYE 289/82 KYE 289/83 KYE 289/84 KYE 289/85 KYE 289/86



L(mm)	B(mm)	H(mm)	
267	125	50	SK 405/05



L(mm)	B(mm)	
270	125	SK 405/61



L(mm)	B(mm)	H(mm)	
270	125	30	SK 405/71



verschiedenes und zubehör
various sizes and accessories
medidas diversos y accesorios
dimensions diverses et accessoires
dimensione diversa e accessori

KYE

nopa[®] instruments





SU 509/25



SU 509/45



Nur Deckel farbig
Lid colored only
Solamente tapas en diferentes colores
Couvercle de couleur seulement
Solo coperchio colorato

L(mm)	B(mm)	H(mm)			
250	60	50	SU 509/25	SU 509/26	SU 509/27
450	70	70	SU 509/45	SU 509/46	SU 509/47

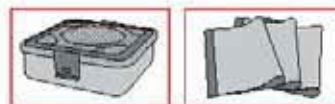

Nur Deckel farbig
Lid colored only
Solamente tapas en diferentes colores
Couvercle de couleur seulement
Solo coperchio colorato

L(mm)	B(mm)	H(mm)			
250	60	50	SU 512/25	SU 512/26	SU 512/27
450	70	70	SU 512/45	SU 512/46	SU 512/47

AA
AB
AC
AD
AE
AF
AK
AL
AO
AP
AR
KA
KL
KM
KO
KU
KYE
X

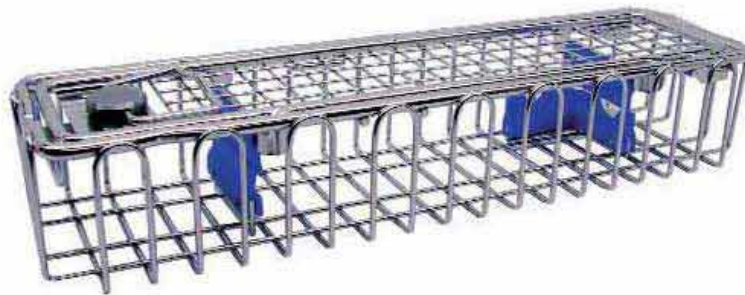
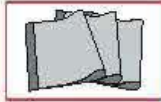

L(mm)	B(mm)	H(mm)	für 1 Endoskop for 1 Telescope	für 2 Endoskope for 2 Telescopes
290	80	52	SU 515/29	SU 516/29
460	80	52	SU 515/46	SU 516/46
640	150	77	SU 515/64	
670	80	52	SU 515/67	



Mit Silikonfixierungen
with silicon fixations

- >> Bürstenspender für 20 Bürsten (ohne Bürsten)
- >> Brush dispenser for 20 brushes (without brushes)
- >> Distribuidor de cepillos para 20 cepillos (sin cepillos)
- >> Distributeur de brosses pour 20 brosses (sans brosses)
- >> Distributore di spazzole per 20 spazzole (senza spazzole)



KY 900/00
 autoklavierbar
 autoclavable
 autoclavable
 autoclavable
 autoclavabile

AA
 AB
 AC
 AD
 AE
 AF
 AK
 AL
 AO
 AP
 AR
 KA
 KL
 KM
 KO
 KU
 X

KYE



FILTER >> FILTERS >> FILTROS >> FILTRES >> FILTRI

PAPIER
PAPER
PAPEL
PAPIERS
CARTA



Standard

x 1000
SX 231/01

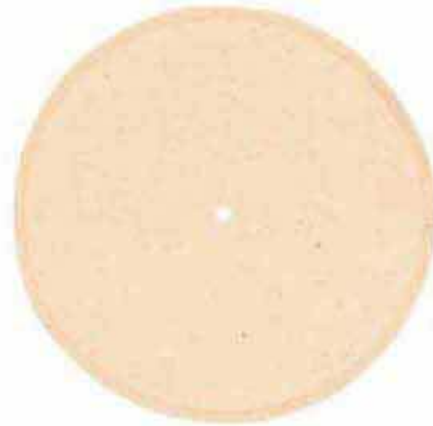

TEXTIL
TEXTILE
TEJIDO
TEXTILE
TESSILI

x 1
SX 233/01

PAPIER
PAPER
PAPEL
PAPIERS
CARTA



Dental = 230 x 170 mm

x 1000
SX 231/11



TEXTIL
TEXTILE
TEJIDO
TEXTILE
TESSILI

x 1
SX 233/11

PAPIER
PAPER
PAPEL
PAPIERS
CARTA



Kleinset = 235 x 118 mm
Small set = 235 x 118 mm

x 1000
SX 231/21



TEXTIL
TEXTILE
TEJIDO
TEXTILE
TESSILI

x 1
SX 233/21



SX 237/00



SX 239/00



x 100
SX 241/01

Standard



x 100
SX 250/01

Klein / Small



x 100
SX 250/02



SX 255/01



SX 255/02



SX 255/03



SX 255/04



SX 255/05



SX 255/06

max. 12 Zeichen
max. 12 Digits



SX 257/01



SX 257/02



SX 257/03



SX 257/04



SX 257/05



SX 257/06



SX 259/00

AA
AB
AC
AD
AE
AF
AK
AL
AO
AP
AR
KA
KL
KM
KO
KU
KYE
X

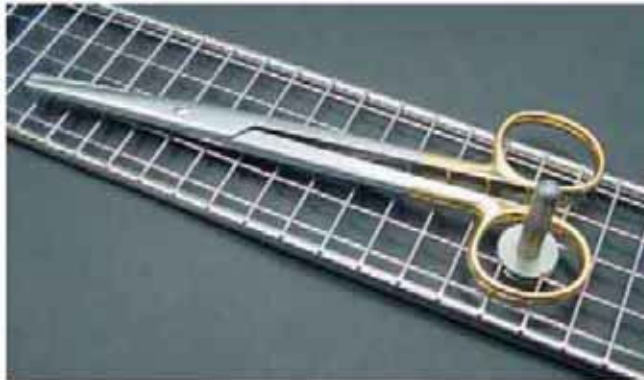

SX 301/01

für Instrumente
for instruments
para instrumentos
pour instruments
per strumenti

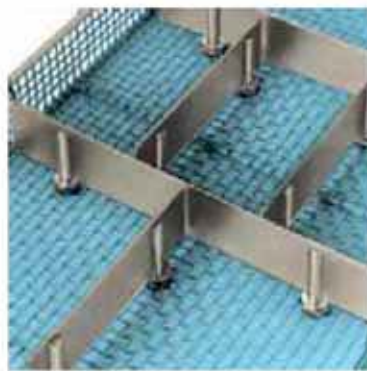

SX 306/01



460 x 20 mm
SX 303/01



225 x 20 mm
SX 303/02



130 x 20 mm
SX 303/03



50 x 20 mm
SX 303/04



Größe / Size
110 mm SX 304/11
170 mm SX 304/17
230 mm SX 304/23
470 mm SX 304/47



SX 306/01



Größe / Size

Ø 7 - 12 mm	SX 315/10
Ø 12 - 16 mm	SX 315/11
Ø 16 - 26 mm	SX 315/12
Ø 26 - 36 mm	SX 315/13
Ø 36 - 45 mm	SX 315/14



L(mm)	B(mm)	
115	30	SX 319/01



L(mm)	B(mm)	
230	30	SX 319/02



L(mm)	B(mm)	
275	125	SX 432/01
225	225	SX 432/02
300	300	SX 432/03
440	230	SX 432/04
520	230	SX 432/05



L(mm)	B(mm)	
60	40	SX 460/01
85	85	SX 460/02
100	140	SX 460/03
275	125	SX 460/04
245	245	SX 460/05

AA
AB
AC
AD
AE
AF
AK
AL
AO
AP
AR
KA
KL
KM
KO
KU
X

KYE

ENDOSKOPIE
ENDOSCOPY
ENDOSCOPIA
ENDOSCOPIE
ENDOSCOPIA

X

nopa[®] instruments

Weitere Endoskopie-Instrumente finden Sie in unserem Katalog „Endoskopie“.

For further endoscopic instruments kindly refer to our catalogue "Endoscopy".

Para instrumental de endoscopia adicional, por favor consulte nuestro catálogo de "Endoscopia".

Pour des instruments d'endoscopie supplémentaires, consultez notre catalogue „Endoscopie“.

Per gli altri strumenti endoscopia, consultare il nostro catalogo "Endoscopia".



>> Trokarhülsen und Trokare >> Trocar Sleeves and Trocars >> Camisa para trocares y trocares >> Trocards à manche et trocards >> Manicotti trequarti e trequarti	417	XK
>> Easy Clean	418-423	XM
>> Sinuskopiehalter, Sinuskopie, Otoskopie >> Sinuscopy-Holder, sinuscopy, otoscopy >> Soporte de senoscopia, senoscopia, otoscopia >> Support pour sinuscopie, sinuscopie, otoscopie >> Sostegno per sinuscopia, sinuscopia, otoscopia	424-426	XP
>> Flexibles Nasopharyngoskop >> Flexible Nasopharyngoscope >> Nasopharyngoscopio flexible >> Nasopharyngoscope flexible >> Nasopharyngoscopio flessibile	427	XQ
>> HF-Instrumente und Zubehör >> HF-Instruments and accessories >> AF-instrumentos y accesorios >> HF-instruments et accessoires >> AF-strumenti ed accessori	428-435	XR
>> Kaltlichtquellen, Kameras >> Cold light sources, cameras >> Fuentes de luz fria, cámaras >> Sources à lumière froide, caméras >> Sorgente luce fredda, macchine fotografiche	436-442	XT
>> Liposuktionspumpe, Verschiedenes >> Liposuction pump, various items >> Bomba de liposucción, artículos diversos >> Pompe de liposuccion, articles divers >> Pompa di liposuzione, articoli diversi	443-445	XU

ENDOSKOPIE ENDOSCOPY ENDOSCOPIA ENDOSCOPIE ENDOSCOPIA

Trokarhülsen und Trokare
Trocar Sleeves and Trocars
Camisa para trocares y trocares
Trocards à manche et trocards
Manicotti trequarti e trequarti

XK

XM

XP

XQ

XR

XT

XU



Ⓐ + Ⓑ Universal sheaths with rotating stopcocks Ⓒ + Ⓓ Standard universal sheaths

UNIVERSAL SHEATHS L = 175 mm

	Ø mm	A	B	C	D
STANDARD	2,7	XK 709/01	XK 709/02	XK 709/03	XK 709/04
	4,0	XK 709/11	XK 709/12	XK 709/13	XK 709/14
SMALL JOINT	2,7	XK 709/31	XK 709/32	XK 709/33	XK 709/34

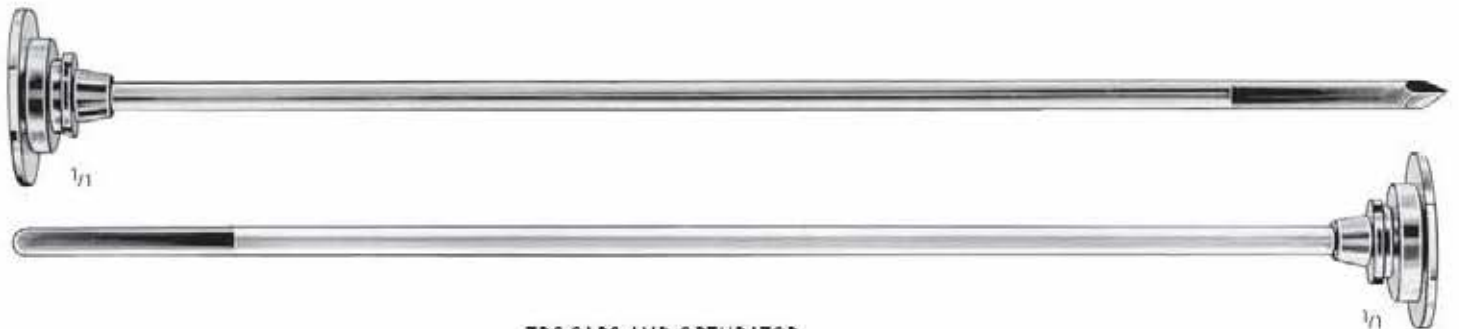

TROCARS AND OBTURATOR

	Ø mm	∧	∩
STANDARD	2,7	XK 710/01	XK 710/02
	4,0	XK 710/11	XK 710/12
SMALL JOINT	2,7	XK 710/31	XK 710/32

easyClean[®]



XM 010/00



XM 014/00



Ø 5,0 mm L 18,0 cm/7" XM 020/18

höchste Präzision und Qualität >> maximum precision and quality standards

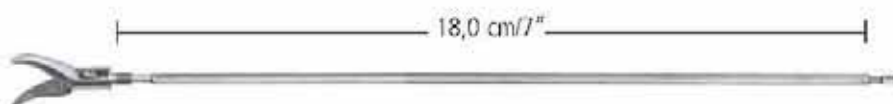

Bestellinformation: Bestellen Sie bitte Griff, Schaft und Arbeitseinsatz.
 Ordering information: Please order handle, tube and working tip.

easyClean[®]

- XM
- XP
- XQ
- XR
- XT
- XU



XM 016/00



Ø 5,0 mm L 18,0 cm/7" XM 020/18

höchste Präzision und Qualität >> maximum precision and quality standards

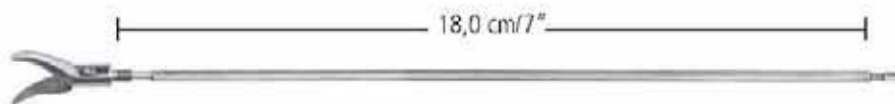

Bestellinformation: Bestellen Sie bitte Griff, Schaft und Arbeitseinsatz.
Ordering information: Please order handle, tube and working tip.

Biopsie, scharfe Präparation
 Biopsy, sharp dissection
 Biopsia, disección en punta
 Biopsie, dissection tranchant
 Biopsia, dissezione tagliente

easyClean[®]

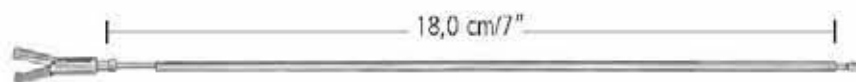

	1/1	Ø 5,0 mm	18,0 cm/7" XM 104/18
STANZE PUNCH			
	1/1	Ø 5,0 mm	XM 108/18
HAKENSTANZE HOOK PUNCH			
	1/1	Ø 5,0 mm	XM 130/18
MICROSCHERE MICRO SCISSORS			
	1/1	Ø 5,0 mm	XM 131/18
MICROSCHERE GEBOGEN MICRO SCISSORS CURVED			
	1/1	Ø 5,0 mm	XM 134/18
HAKENSCHERE HOOK SCISSORS			
	1/1	Ø 5,0 mm	XM 138/18
METZENBAUM SCHERE METZENBAUM SCISSORS			
	1/1	Ø 5,0 mm	XM 139/18
METZENBAUM SCHERE GEBOGEN METZENBAUM SCISSORS CURVED			

Stumpfe Präparation, Faszang(en)
 Blunt Dissection, grasping forceps
 Disección roma, pinzas de aprehensión
 Dissection émoussée, pinces à préhension
 Dissezione smusse, pinze da presa

easyClean[®]

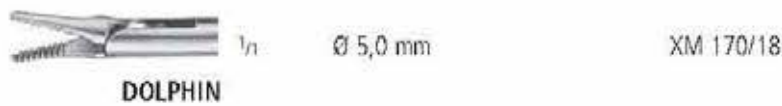

XK
 XM
 XP
 XQ
 XR
 XT
 XU

Fasszangen
Grasping forceps
Pinzas de aprehensión
Pinces à préhension
Pinze da presa

easyClean[®]

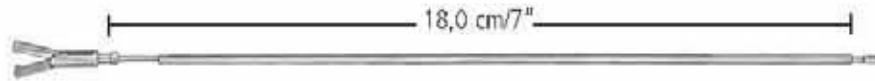

	1/1	Ø 5,0 mm	18,0 cm/7"	XM 212/18
SCHARFER ATRAUMATISCHER GREIFER SHARP ATRAUMATIC GRASPER				

	1/1	Ø 5,0 mm		XM 214/18
GEZAHNTER GREIFER KOBRA TOOTHED GRASPER COBRA				

	1/1	Ø 5,0 mm		XM 216/18
ALLIGATOR GREIFZANGE ALLIGATOR GRASPING FORCEPS				

	1/1	Ø 5,0 mm	5,0 x 30,0 mm 5,0 x 40,0 mm 5,0 x 50,0 mm	XM 220/18 XM 221/18 XM 222/18
DE BAKEY				

	1/1	Ø 5,0 mm	2,5 x 30,0 mm 2,5 x 40,0 mm 2,5 x 50,0 mm	XM 228/18 XM 229/18 XM 230/18
GLASSMAN				

	1/1	Ø 5,0 mm		XM 236/18
ALLIS				

Fasszangen
Grasping Forceps
Pinzas de aprehensión
Pinces à préhension
Pinze da presa

easyClean[®]

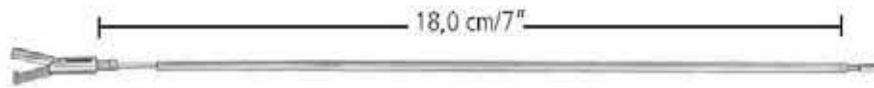

BABCOCK

1/1

Ø 5,0 mm

18,0 cm/7"

XM 245/18



**KRALLENGREIFER
CLAW FORCEPS**

1/1

Ø 5,0 mm

XM 254/18



McKERNAN

1/1

Ø 5,0 mm

XM 258/18



HUNTER

1/1

Ø 5,0 mm

XM 260/18

XK

XM

XP

XQ

XR

XT

XU

Sinuskophalter
 Sinuscope-Holder
 Soporte de sinuscopia
 Support pour sinuscope
 Sostegno per sinuscopia



Fig. 1
 XP 690/01



Fig. 2
 XP 690/02



>> autoklavierbar
autoclavable

>> mit Anschluss für
with adaptors for

Storz
Wolf
ACMI

1/1

	STANDARD 90°		
Ø mm	$\alpha = 0^\circ$	$\alpha = 30^\circ$	$\alpha = 70^\circ$
2,7	XP 700/30	XP 700/33	XP 700/37



>> autoklavierbar
autoclavable

>> mit Anschluss für
with adaptors for

Storz
Wolf
ACMI

1/1

Ø mm	$\alpha = 0^\circ$	$\alpha = 30^\circ$	$\alpha = 70^\circ$
4,0	XP 703/40	XP 703/43	XP 703/47 Wide angle



>> autoklavierbar
autoclavable

>> mit Anschluss für
with adaptors for

Storz
Wolf
ACMI

1/1

	STANDARD 90°		
Ø mm	$\alpha = 0^\circ$	$\alpha = 30^\circ$	$\alpha = 70^\circ$
2,7	XP 704/30	XP 704/33	XP 704/37

Otoskopie
 Otoscopy
 Otoscopia
 Otoscopie
 Otoscopia



>> **autoklavierbar**
autoclavable

>> **mit Anschluss für**
with adaptors for

Storz
Wolf
ACMI

	STANDARD 90°	
Ø mm	$\alpha = 0^\circ$	$\alpha = 30^\circ$
4,0	XP 718/40	XP 718/43

Flexibles Nasopharyngoskop
Flexible Nasopharyngoscope
Nasopharyngoscopia flexible
Nasopharyngoscope flexible
Nasopharyngoscopia flessibile

flexible nasopharyngoscope

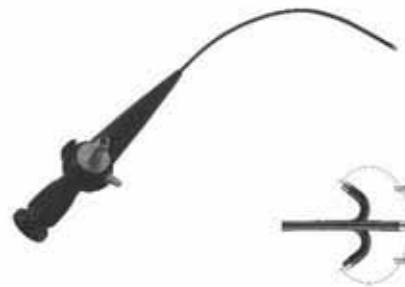

XQ 510/30

Das nopa Nasopharyngoskop wird komplett mit Aufbewahrungskoffer und Drucktester geliefert.
The nopa nasopharyngoscope will be delivered in a case and with a pressure testing device.

Flexibles Nasopharyngoskop

Beschreibung XQ 510/30

Diese neue Generation des flexiblen Nasopharyngoskops von nopa wurde unter Berücksichtigung der neuesten Produktionsmethoden und Technologien in enger Zusammenarbeit mit klinischen Anwendern entwickelt.
Die innovativen Besonderheiten und die herausragende optische Qualität garantieren dem Benutzer ein optimales Bild.

Die neue Generation der Bildübertragungs-Technik liefert brillante Detailaufnahmen sowohl in den Ecken eines Bildes als auch in der Bildmitte. Das Erkennen kleinster Strukturen wird dadurch erheblich erleichtert. Die Wiedergabe der natürlichen Farben ermöglicht dem Benutzer eine bessere Diagnostik.

Das nopa Nasopharyngoskop bietet ein Höchstmaß an Hygiene.

Technische Daten

XQ 510/30 nopa Nasopharyngoskop

Bildwinkel: 85°
Tiefenschärfe: 2,5 - 5,0 mm
Außendurchmesser: 3,6 mm
Außendurchmesser distales Ende: 3,6 mm
Nutzlänge: 300 mm

Schwenkbereich des distalen Endes

Aufwärts: 125°
Abwärts: 125°

Technische Änderungen zur Produktverbesserung vorbehalten.

flexible nasopharyngoscope

Description XQ 510/30

This new generation of the flexible nasopharyngoscope from nopa has been newly developed in close cooperation with clinical users, with an eye to production methods and technologies.
The innovative features and the outstanding optical quality provide the best image for the user.

The new generation of image transmission technology provides brilliant detail definition at the edges of the images as well as in the centre. Recognition of even the smallest structures is thereby greatly facilitated. The natural colour rendition assists the user with better diagnostic.

The new generation is also designed for optimum hygiene.

Technical data

XQ 510/30 nopa nasopharyngoscope

Field of view: 85°
Depth of field: 2,5 - 5,0 mm
Outer diameter insertion tube: 3,6 mm
Outer diameter distal end: 3,6 mm
Working length: 300 mm

Bending range of distal tip

Upward: 125°
Down: 125°

Specification subject to change without notice.

nopa[®] high frequency surgical unit



XR 102/00 – 115/230 VAC/50-60Hz

nopa Hochfrequenz-Chirurgiegerät

nopa high frequency surgical unit

Beschreibung XR 102/00

Das ideale HF-Gerät für chirurgische Eingriffe.

Kompaktes, platzsparendes Design sowie die einfache, benutzerfreundliche Bedienung sind weitere Vorteile.

Description XR 102/00

The ideal high frequency surgical unit for surgical operations.

The compact, efficient design, as well as the easy handling are further advantages.

Technische Daten

Technical data

Maße (B x H x T):	270 x 127 x 260 mm
Gewicht:	ca. 5,5 kg
Schneiden 1:	80 Watt, 500 Ohm
Schneiden 2:	70 Watt, 1000 Ohm
Koagulation 1:	70 Watt, 500 Ohm
Koagulation 2:	60 Watt, 1000 Ohm
Koagulation Bipolar:	70 Watt, 100 Ohm
Typ:	BF
Netzanschluss:	115/230 VAC / 50-60 Hz

Measurements (W x H x D):	270 x 127 x 260 mm
Weight:	approx. 5,5 kg
Cut 1:	80 Watt, 500 Ohm
Cut 2:	70 Watt, 1000 Ohm
Coagulation 1:	70 Watt, 500 Ohm
Coagulation 2:	60 Watt, 1000 Ohm
Coagulation Bipolar:	70 Watt, 100 Ohm
Type:	BF
Mains supply:	115/230 VAC / 50-60 Hz

Elektrodenhandgriffe
 Electrode handles
 Mangos porta-electrodos
 Mandres porte-électrodes
 Mandini porta elettrodi

XK

XM

XP

XQ

XR

XT

XU



1/2

ERBE
XR 800/01



1/2

MARTIN/BERCHTOLD
XR 800/05



1/2

MARTIN/BERCHTOLD
XR 801/05



MARTIN/BERCHTOLD
XR 802/05

Elektrodenhandgriffe mit Kabel
 Electrode handles with cable
 Mangos porta-electrodos con cable fijo
 Manches porte-électrodes avec câble
 Mancini porta elettrodi con cavo



MARTIN/BERCHTOLD
XR 803/05

ERBE (U.S.)
XR 804/01

VALLEYLAB
XR 805/09

VALLEYLAB
XR 806/09

Anschlusskabel
 Connection cords
 Cables de conexión
 Câbles de raccordement
 Cavi da connessione

XK
 XM
 XP
 XQ
XR
 XT
 XU

monopolar

bipolar



300 cm
 500 cm

XR 827/03
 XR 827/05

MARTIN / BERCHTOLD

XR 828/03
 XR 828/05

XR 830/03
 XR 830/05

monopolar

bipolar

monopolar

bipolar



300 cm
 500 cm

ERBE
 XR 831/03
 XR 831/05
 (ACC/ICC)

ERBE
 XR 831/13
 XR 831/15
 (T-Serie)

ERBE/SELECT
 XR 832/03
 XR 832/05

ERBE
 XR 833/03
 XR 833/05

VALLEYLAB
 XR 834/03
 XR 834/05
 (in D nicht zulässig
 nach MedGV)

Anschlusskabel
 Connection cords
 Cables de conexión
 Câbles de raccordement
 Cavi da connessione

für neutralelektroden
 for patient plates



300 cm
 500 cm



XR 835/35
 XR 835/55



300 cm
 500 cm



XR 836/31
 XR 836/51

monopolar



Monopolares Hochfrequenzkabel
 Monopolar high frequency cord
 L = 3,0 m XR 837/03
 L = 5,0 m XR 837/05

Elektroden
Electrodes
Electrodes
Electrodes
Elettrodi

universal



XR 841/01



XR 841/02



XR 841/03



XR 841/04



XR 841/05



XR 841/06



XR 841/07



XR 841/08



XR 841/09



XR 841/10



XR 841/11



XR 841/12

XK
XM
XP
XQ
XR
XT
XU

Elektroden
Electrodes
Electrodos
Electrodes
Elettrodi

universal



XR 843/01



XR 843/02



XR 843/03



XR 843/04



XR 843/05



XR 843/06



XR 843/07



XR 843/08



XR 843/09

ENDOSKOPIE ENDOSCOPY ENDOSCOPIA ENDOSCOPIE ENDOSCOPIA

Bi-Koagulations-Pinzetten
 Bi-Coagulation-Forceps
 Pinzas para la Bi-Coagulación
 Pince pour la Bi-Coagulation
 Pinze per la Bi-Coagulazione

XK
 XM
 XP
 XQ
XR
 XT
 XU



16,0 cm/6 ¹ / ₄ "	XR 890/16 A	XR 891/16 C	XR 894/16 C		
16,0 cm/6 ¹ / ₄ "	XR 890/16 C	XR 891/16 D	XR 894/16 D		
16,0 cm/6 ¹ / ₄ "	XR 890/16 E	XR 891/16 E	XR 894/16 E		
20,0 cm/8"	XR 890/20 A	XR 891/20 A	XR 894/20 A		
20,0 cm/8"	XR 890/20 C	XR 891/20 C	XR 894/20 C	XR 895/20 C	XR 896/20 C
20,0 cm/8"	XR 890/20 E	XR 891/20 F	XR 894/20 E		
20,0 cm/8"			XR 894/20 F		
22,0 cm/8 ³ / ₄ "	XR 890/22 A	XR 891/22 C	XR 894/22 D		
22,0 cm/8 ³ / ₄ "	XR 890/22 C		XR 894/22 E	XR 895/22 C	XR 896/22 C

A=2,0 mm

C=1,0 mm



D=0,5 mm

E=Nadel

F=Profil



11,0 cm/4 ¹ / ₃ "	XR 898/11 D	XR 899/11 D
11,0 cm/4 ¹ / ₃ "	XR 898/11 E	XR 899/11 E

Kaltlichtkabel
 Fibre optic cable
 Cable fibra óptica
 Câble fibre optique
 Cavo fibra ottica



XT 035/18	Ø 3,5 mm, 180 cm
XT 035/23	Ø 3,5 mm, 230 cm
XT 035/30	Ø 3,5 mm, 300 cm
XT 045/18	Ø 4,5 mm, 180 cm
XT 045/23	Ø 4,5 mm, 230 cm
XT 045/30	Ø 4,5 mm, 300 cm
XT 060/18	Ø 6,0 mm, 180 cm
XT 060/23	Ø 6,0 mm, 230 cm
XT 060/30	Ø 6,0 mm, 300 cm

Kaltlicht-Grundkabel
Basic fibre optic cable



XT 070/18	Ø 4,5 mm, 180 cm
XT 070/23	Ø 4,5 mm, 230 cm
XT 070/30	Ø 4,5 mm, 300 cm

>> **Zusätzliche Isolierung**
 >> **Metallspirale**
 >> **Silikonmantel**
 >> **Sterilisierbar**

>> **Additionally insulated**
 >> **Metal spiral**
 >> **Silicon tube**
 >> **Autoclavable**

Adapter
Adapter
Adaptador
Connexion
Adattatore

XK

XM

XP

XQ

XR

XT

XU

**Projektor-Seite
Projector side**

**Endoskop-Seite
Endoscope side**

XT 100/01



STORZ



XT 100/11

**STORZ/WINTER + IBE
OLYMPUS/STRYKER**

XT 100/02



WOLF/HENKE-SASS



XT 100/12

WOLF/HENKE-SASS

XT 100/03



ACM/HEINE



XT 100/13

ACM/HEINE

XT 100/04



WINTER + IBE

XT 100/05



OLYMPUS

Bestellinformation / Ordering information

>> Bitte bestellen Sie Kaltlicht-
grundkabel mit 2 Adaptern

>> Please order the basic fibre
optic cable and two adapters

Kaltlichtquellen
Cold light sources
Fuente de luz fría
Source à lumière froide
Sorgente luce fredda

nopa[®] light halogen 150W



XT 140/00 = 230 VAC/50Hz
XT 140/01 = 110 VAC/60Hz

XT 139/00 = Ersatzlampe
Spare bulb
Bombilla de recambio
Lampe de rechange
Lampadina di ricambio

nopalight halogen 150W

Beschreibung XT 140/00 - XT 140/01

Die nopalight halogen 150 W Lichtquelle kann bei allen endoskopischen Einsätzen angewendet werden, bei welchen die Lichtintensität nicht allzu hoch sein muss, beispielsweise in der Arthroskopie, Diagnostik oder der Mikroskopie.

Die nopalight 150 W Lichtquelle bietet eine konstant lichtstarke Ausleuchtung des Untersuchungsfeldes, mittels einer stufenlosen Helligkeitsregelung.

Kompaktes, platzsparendes Design sowie die einfache, benutzerfreundliche Bedienung sind weitere Vorteile.

Technische Daten

XT 140/00 = 230 VAC/50Hz
XT 140/01 = 110 VAC/60Hz

Farbtemperatur:	max. 3600° K
Maße (B x H x T)	190 x 115 x 180 mm
Gewicht:	ca. 3,3 kg
Lampe XT 139/00:	150 Watt Halogen

nopalight halogen 150W

Description XT 140/00 - XT 140/01

The nopalight halogen 150 W lightsource, can be utilized in all endoscopic procedures, where extreme light-intensity is not required, i.e. arthroscopy, diagnostics and microscopy.

The nopalight 150 W lightsource offers a constant light-intensity for the illumination of the operating field by means of continuous brightness control.

The compact, efficient design, as well as the easy handling are further advantages.

Technical data

XT 140/00 = 230 VAC/50Hz
XT 140/01 = 110 VAC/60Hz

Color temperature:	max. 3600° K
Measurements (W x H x D):	190 x 115 x 180 mm
Weight:	approx. 3,3 kg
Bulb XT 139/00:	150 Watt Halogen

Kaltlichtquellen
Cold light sources
Fuente de luz fría
Source à lumière froide
Sorgente luce fredda

nopa[®] light halogen 2 x 250W future 100

XT 170/00	–	110 - 230 VAC
XT 169/00	–	Ersatzlampe Spare bulb Bombilla de recambio Lampe de rechange Lampadina di ricambio



nopalight halogen 2 x 250W

Beschreibung XT 170/00

Die nopalight halogen 2 x 250 W Lichtquelle kann bei allen Einsätzen angewendet werden, besonders dann, wenn eine starke Ausleuchtung oder eine Videoaufzeichnung notwendig ist.

Alle modernen Autoshutter-Videokameras werden mit ausreichender Lichtzufuhr versorgt. Die zweite Lampe wird als Reserve bei Lampendefekten oder Lampenausfall durch sofortiges Umschalten während den Einsätzen aktiviert.

Spezielle Wärmeschutzfilter sorgen für eine Schonung der Lichtleiter und eine optimale Lichtfiltrierung. Das Gerät ist MedGV-geprüft.

Technische Daten

Elektr. Versorgung:	100-240 VAC/50-60Hz Weltnetzteil
Farbtemperatur:	über 3500° K
Lichtregelung:	automatisch, stufenlos
Maße (B x H x T):	355 x 110 x 320 mm
Gewicht:	ca. 8,5 kg

Zubehör

Lampe XT 169/00:	250 Watt Halogen
------------------	------------------

nopalight halogen 2 x 250W

Description XT 170/00

The nopalight halogen 2 x 250 W lightsource can be utilized in all procedures, especially if a strong illumination or video-monitoring is required.

All modern autoshutter-videocameras will be supplied with sufficient light-intensity, the second lamp serves as stand-by. Simply switch-over.

Special temperature-filters guarantee long life of light cables and optimal light output. The nopalight halogen 2 x 250 W lightsource is approved by MedGV.

Technical data

Power supply:	100-240 VAC/50-60Hz world power supply
Color temperature:	more than 3500° K
Light control:	automatic
Measurements (W x H x D):	355 x 110 x 320 mm
Weight:	approx. 8,5 kg

Accessories

Bulb XT 169/00:	250 Watt Halogen
-----------------	------------------

Kaltlichtquellen
Cold light sources
Fuente de luz fría
Source à lumière froide
Sorgente luce fredda

nopa[®] light xenon future 200 180W



XT 205/00 – 110-230 VAC/50/60 Hz

XT 204/00 – Ersatzlampe
Spare bulb
Bombilla de recambio
Lampe de rechange
Lampadina di ricambio

nopalight xenon 180W

Beschreibung XT 205/00

Die nopalight xenon 180 Watt Lichtquelle kann bei allen Einsätzen angewendet werden, besonders dann, wenn eine starke Ausleuchtung oder eine Videoaufzeichnung notwendig ist.

Alle modernen Autoshutter-Videokameras werden mit ausreichender Lichtzufuhr versorgt. Die hohe Lichtausgangsleistung sorgt für absolut weißes Licht >5600°K und somit für detailgetreue Farbwiedergabe.

Unsere spezielle Lampenkonstruktion mit geringster Wärmeentwicklung führt zu absolut kaltem Licht und verhindert eine thermische Beschädigung der Lichtleiter.

Weitere Vorteile: Geringe Luftverwirbelungen, geringe Geräuschentwicklung, umweltfreundliche Lampe, einfachster Lampenwechsel.

Technische Daten

Elektr. Versorgung: 110-230 VAC/50-60Hz
Weltnetzteil

Farbtemperatur: > 5600° K

Maße (B x H x T): 355 x 110 x 320 mm

Gewicht: ca. 9,5 kg

Zubehör

Lampe XT 204/00: 180 Watt Xenon

nopalight xenon 180W

Description XT 205/00

The nopalight xenon 180 watt light source can be used for all occasions particularly where strong illumination or a video recording is necessary.

All modern autoshutter videocameras are supplied with sufficient light. The high light output ensures absolute white light >5600° K and thus detail fidelity in colour reproduction.

Our special lamp construction which has the lowest of heat generation leads to absolute cold light and prevents thermal damage to the light conductor.

Further advantages are low air turbulence, low noise level, environmentally friendly lamp and very easy bulb replacement.

Technical data

Power supply: 110-230 VAC/50-60Hz
world power supply

Colour temperature: > 5600° K

Measurements (W x H x D): 355 x 110 x 320 mm

Weight: approx. 9,5 kg

Accessories

Bulb XT 204/00: 180 Watt Xenon

nopa[®] cam digital camera system

immersible
soakable

PAL/SECAM XT 302/00	-	XT 310/00	Netzkabel/mains cord
		XT 302/10	Kamerakopf inkl. Kabel 3,8 m, einlegbar/ camera head incl. cable 3,8 m, immersible
		XT 302/12	Kameraprozessor/camera control unit
		XT 344/02	Kabel/cable S-VHS
NTSC XT 302/01	-	XT 310/00	Netzkabel/mains cord
		XT 302/11	Kamerakopf inkl. Kabel 3,8 m, einlegbar/ camera head incl. cable 3,8 m, immersible
		XT 302/13	Kameraprozessor/camera control unit
		XT 344/02	Kabel/cable S-VHS



Beschreibung XT 302/00 / XT 302/01

Das nopa cam camera system ist eine wirtschaftliche Office-Kamera mit ausgezeichneten Eigenschaften. Beste Bildqualität, scharfe Bildzeichnung und Klarheit werden durch den 1/4" CCD-Chip gewährleistet.

Die optimale Bilddarstellung aufgrund eines hochempfindlichen Mikro-Linsen-Chip sowie einer äußerst schnellen Blende wird auch unter schwierigen Beleuchtungsbedingungen sichergestellt. Der Kamerakopf ist leicht, ergonomisch und einlegbar. Der automatische Weißabgleich wird durch Schalterdruck aktiviert und ist im Memory gespeichert.

Aufgrund des hohen Automatisierungsstandards der nopa cam S ist das Kamerasystem sehr bedienerfreundlich.

Technische Daten

XT 302/00 PAL - XT 302/01 NTSC

CCD Sensor:	1/4" Chip
Video-Auflösung:	über 500 Linien
Minimale Beleuchtung:	0,9 Lux
Video Ausgang:	FBAS oder Y/C (S-VHS)
Elektr. Versorgung:	110/115 VAC - und 230/240 VAC
Gewicht:	1 kg

Weiteres Zubehör

XT 302/02 Kamera mit C-Mount Gewinde PAL
 XT 302/03 Kamera mit C-Mount Gewinde NTSC
 XT 306/00 Bildteiler

XT 361/40 Zoom Adapter 15 - 25 mm
 XT 361/50 Zoom Adapter 25 - 40 mm
 verwendbar mit XT 302/02 und XT 302/03

Description XT 302/00 / XT 302/01

The nopa cam camera system is an economic office camera with excellent characteristics. The best possible picture quality, picture delineation and clarity are ensured by the 1/4" CCD chip.

Optimal picture presentation is ensured by a highly sensitive micro-lens chip with an extremely rapid diaphragm even under difficult lighting conditions. The camera head is light, ergonomic and immersible. The automatic white compensation is activated by press button and is stored in the memory.

The nopa cam S high level of automatic operation makes this camera system extremely easy to operate.

Technical data

XT 302/00 PAL - XT 302/01 NTSC

CCD sensor:	1/4" chip
Video resolution:	more than 500 lines
Minimal illumination:	0,9 Lux
Video output:	FBAS or Y/C (S-VHS)
Power Supply:	110/115 VAC - and 230/240 VAC
Weight:	1 kg

Optional accessories

XT 302/02 camera with C-mount adapter PAL
 XT 302/03 camera with C-mount adapter NTSC
 XT 306/00 beam splitter

XT 361/40 Zoom adapter 15 - 25 mm
 XT 361/50 Zoom adapter 25 - 40 mm
 to use with XT 302/02 and XT 302/03

XX

XM

XP

XQ

XR

XT

XU

Zoom - Adapter
 Zoom - Adapter
 Zoom - Adaptador
 Zoom - Connexion
 Zoom - Adattatore



XT 361/40

Zoom - Objektiv	15 mm - 25 mm
zoom - objective	15 mm - 25 mm



XT 361/50

Zoom - Objektiv	25 mm - 40 mm
Zoom - objective	25 mm - 40 mm

Zoom Adapter mit C-Mount Anschluss für nopa Kameras
 XT 301/02, XT 301/03, XT 302/02, XT 302/03 und XT 305/00, XT 305/01.
 Zoom adapter with C-mount connection for nopa camera systems
 XT 301/02, XT 301/03, XT 302/02, XT 302/03 and XT 305/00, XT 305/01.

liposuction pump

XU 305/60 – 115-230 VAC / 50-60 Hz



Beschreibung XU 305/60

Leistungsfähigkeit und Zuverlässigkeit machen diese Absaugpumpe vielseitig einsetzbar. Leistungsstark, effizient und zuverlässig für höchste Ansprüche in Dauerbetrieb für z.B.:

- Operationsaal/Chirurgie
- Liposuktion
- Arztpraxis/Zahnarztpraxis
- Intensivabteilungen
- Betrieb mit 2-Liter Sekretflasche und einer Saugleistung von 60 l/min möglich
- Bedienbar mit ON/Off-Fußregler

Technische Daten:

Luftdurchsatz:	60l / min
Vakuum (max.):	- 0,9 bar / 686 mmHG
Pumpentyp:	Kolbenpumpe
Sekretflasche:	2 Liter
Maße (B x H x T):	300 x 360 x 280 mm
Gewicht:	1300 g
Zulassung:	CE / CSA / FDA

XU 305/60

Saug System inklusive:

XU 305/06	Pumpe
XU 305/91	Sekretflasche 2l
XU 305/92	Saugdeckel
Netzanschluss:	115/230 VAC / 50-60 Hz

Description XU 305/60

Performance and reliability make this suction pump suitable for a wide range of applications. High-performance, efficient, and reliable for the most demanding requirements and continuous operation, for example:

- Operating room / surgery
- Liposuction
- Doctor's practice / dental practice
- Intensive care unit
- Operation with 2-liter secretion bottle and a suction capacity 60 l/min possible
- Operated with on/off foot controller

Technical Data:

Air flow rate:	60l / min
Vacuum (max.):	- 0,9 bar / 686 mmHG
Pump type:	piston pump
Secretion bottle:	2 litres
Measurements (W x H x D):	300 x 360 x 280 mm
Weight:	1300 g
Approvals:	CE / CSA / FDA

XU 305/60

Suction System including:

XU 305/06	pump
XU 305/91	secretion bottle 2l
XU 305/92	suction lid
Mains supply:	115/230 VAC / 50-60 Hz

Gelenkarmsystem mit zentraler Schnellfixierung
 Articulated arm with quick central fixation
 Sistema de brazo articulado con fijación rápida central
 Système de bras articulé avec fixation rapide centrale
 Sistema a braccio articolato con fissaggio rapido centrale



Komplett kurz / short complete

XU 650/01 = XU 650/13
 XU 650/40
 XU 651/01
 XU 651/12

Komplett lang / long complete

XU 650/02 = XU 650/13
 XU 650/55
 XU 651/02
 XU 651/12

Zubehör auf der Nebenseite
 Accessories on the opposite side

ENDOSKOPIE ENDOSCOPY ENDOSCOPIA ENDOSCOPIE ENDOSCOPIA

Gelenkarmsystem mit zentraler Schnellfixierung
 Articulated arm with quick central fixation
 Sistema de brazo articulado con fijación rápida central
 Système de bras articulé avec fixation rapide central
 Sistema a braccio articolato con fissaggio rapido centrale

Halterungen
Holders



XU 650/11
 Kombi Instrumentenhalter
 Combined Instrument holder



XU 650/12
 Ø 4 mm Optikhalter
 Ø 4 mm Optic holder



XU 650/13
 Ø 5 mm/10 mm Optikhalter
 Ø 5 mm/10 mm Optic holder



XU 650/14
 Ø 8 mm Optikhalter
 Ø 8 mm Optic holder

Gelenkarme
Articulated arms

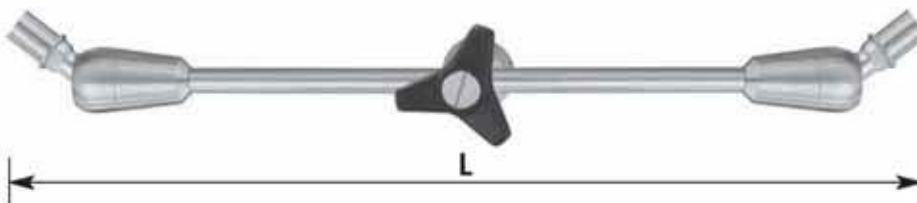

XU 650/40
 L = 400 mm m8/m12x1 Ø16 mm

XU 650/55
 L = 550 mm m8/m12x1 Ø16 mm

Säulen
Columns



XU 651/01 Ø16 mm 300 mm
 XU 651/02 Ø16 mm 400 mm



XU 651/03
 Ø16 mm 450 mm x 100 mm



XU 651/04
 Ø16 mm 266 x 300 x 116 mm

Klemmsockel
Clamping socket



XU 651/11
 Universalsockel
 Universal clamping socket



XU 651/12
 Schienensockel
 Rails clamping socket



XU 651/13
 Isolierter Schienensockel
 Insulated rails clamping socket

XK
 XM
 XP
 XQ
 XR
 XT
XU

